

- Performance hollow shaft encoder for heavy duty industries
- High vibration and shock resistance
- Electrically insulated shaft



Technical data

| | |
|--------------------------------------|--|
| Operating temperature | -20 °C .. +85 °C |
| Ingress protection class [IEC 60529] | IP67 (IP66 at shaft inlet) |
| Vibration [IEC 60068-2-6] | ≤ 200 m/s ² |
| Shock [IEC 60068-2-27] | ≤ 1500 m/s ² |
| Cover material | Aluminium (coated) |
| Weight | 1300 g |
| Shaft load (axial/radial) | 100 N / 300 N |
| Rotational speed max | 6000 rpm |
| Shaft material | Stainless steel with insulated peek insert |
| Short circuit protected | Yes |
| Polarity protected | Yes |
| Current consumption | 60 mA at 24 Vdc (Max. 80 mA) |
| Output load | ± 40 mA |
| Output frequency max | 200 kHz |
| Cable length max | 350 m at 100 kHz |
| Channel separation | 90° el ± 25° el |
| Dividing error | ±50° el |

Encoder configuration

| | |
|----------------------------|---------------------------|
| Code key description | 861108456 |
| Type | XHI |
| Model | 861 |
| Shaft type | Ø16 mm blind hollow shaft |
| Flange type | 86-flange |
| Resolution | 100 |
| Power supply | 9-30 Vdc |
| Output signal | HC-HTL |
| Connection type | Cable gland |
| Connecting direction | Radial |
| Cable gland dimension | M20 for Ø8-11 mm cables |
| Number of channels | 6 |
| Advanced Diagnostic System | Available upon request |
| Torque bracket | 120 degrees orientation |

Dimensions

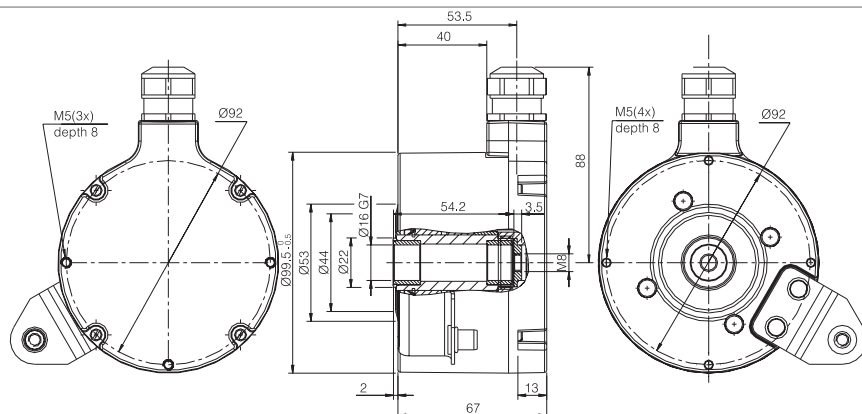

Output signals

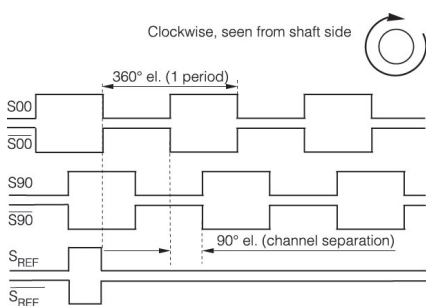

Pin configuration

| Function | Terminal |
|--------------------|----------|
| +E Volt | 1 |
| 0 Volt | 2 |
| 0 (Sref) | 3 |
| 0 inverted (Sref\) | 4 |
| 1 (S90) | 5 |
| 1 inverted (S90\) | 6 |
| 2 (S00) | 7 |
| 2 inverted (S00\) | 8 |
| Shield | Chassis |

Ordering information

Part number

751533-03