

- Performance encoder for heavy duty industries
- Euro-flange and solid shaft 11 mm with key nut
- High vibration and shock resistance



## Technical data

Operating temperature	-40 °C .. +85 °C
Ingress protection class [IEC 60529]	IP67 (IP66 at shaft inlet)
Vibration [IEC 60068-2-6]	≤ 200 m/s <sup>2</sup>
Shock [IEC 60068-2-27]	≤ 1500 m/s <sup>2</sup>
Cover material	Aluminium (coated)
Weight	1300 g
Shaft load (axial/radial)	100 N / 100 N
Rotational speed max	6000 rpm
Shaft material	Stainless steel
Short circuit protected	Yes
Polarity protected	Yes
Current consumption	60 mA at 24 Vdc (Max. 80 mA)
Output load	± 40 mA
Output frequency max	200 kHz
Cable length max	350 m at 100 kHz
Channel separation	90° el ± 25° el
Dividing error	±50° el

## Encoder configuration

Code key description	850019456
Type	XSI
Model	850
Shaft type	Ø11 mm with key nut
Flange type	Euro-flange (B10-type)
Resolution	1024
Power supply	9-30 Vdc
Output signal	HC-HTL
Connection type	Cable gland + ADS Classic
Connecting direction	Radial
Cable gland dimension	M20 for Ø8-11 mm cables
Number of channels	6
Advanced Diagnostic System	ADS Classic

## Dimensions

Drawing available upon request to Leine & Linde.

## Output signals

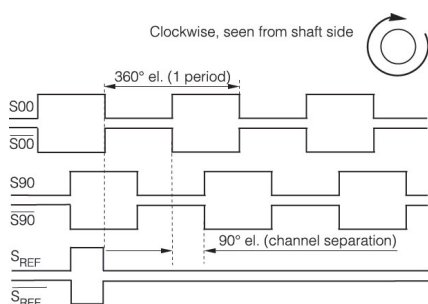

## Pin configuration

Function	Pin
+E Volt	1
0 Volt	2
0 (Sref)	3
0 inverted (Sref\)	4
1 (S90)	5
1 ibnverted (S90\)	6
2 (S00)	7
2 inverted (S00\)	8
Alarm +	9
Alarm -	10
RXD	11
TXD	12
Chassis	Shield

## Ordering information

Part number

751277-03