

- Performance encoder for heavy duty industries
- Euro-flange and solid shaft 11 mm with key nut
- High vibration and shock resistance



Technical data

Operating temperature	-40 °C .. +85 °C
Ingress protection class [IEC 60529]	IP67 (IP66 at shaft inlet)
Vibration [IEC 60068-2-6]	≤ 200 m/s ²
Shock [IEC 60068-2-27]	≤ 1500 m/s ²
Cover material	Aluminium (coated)
Weight	1300 g
Shaft load (axial/radial)	100 N / 100 N
Rotational speed max	6000 rpm
Shaft material	Stainless steel
Short circuit protected	Yes
Polarity protected	Yes
Current consumption	60 mA at 24 Vdc (Max. 80 mA)
Output load	± 40 mA
Output frequency max	200 kHz
Cable length max	350 m at 100 kHz
Channel separation	90° el ± 25° el
Dividing error	±50° el

Encoder configuration

Code key description	850009356
Type	XSI
Model	850
Shaft type	Ø11 mm with key nut
Flange type	Euro-flange (B10-type)
Resolution	5000
Power supply	9-30 Vdc
Output signal	HC-HTL
Connection type	Cable
Connecting direction	Radial
Cable length	1.50 m
Cable gland dimension	M20 for Ø8-11 mm cables
Number of channels	6
Advanced Diagnostic System	Available upon request

Dimensions

Drawing available upon request to Leine & Linde.

Output signals

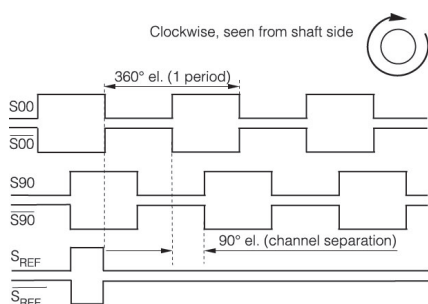

Pin configuration

Function	Colour
+E volt	Red
0 Volt	Blue
0 (Sref)	Brown
0 inverted (Sref\)	Violet
1 (S90)	Green
1 inverted (S90\)	White
2 (S00)	Yellow
2 inverted (S00\)	Black
Chassis	Shield

Ordering information

Part number

750728-16