

- Performance hollow shaft encoder for heavy duty industries
- High vibration and shock resistance
- Electrically insulated shaft



Technical data

Operating temperature	-20 °C .. +100 °C
Ingress protection class [IEC 60529]	IP67 (IP66 at shaft inlet)
Vibration [IEC 60068-2-6]	≤ 200 m/s ²
Shock [IEC 60068-2-27]	≤ 1500 m/s ²
Cover material	Aluminium (anodized)
Weight	1400 g
Shaft load (axial/radial)	50 N / 100 N
Rotational speed max	6000 rpm
Shaft material	Stainless steel with insulated peek insert
Short circuit protected	Yes
Polarity protected	Yes
Current consumption	60 mA at 24 Vdc (Max. 80 mA)
Output load	± 40 mA
Output frequency max	200 kHz
Cable length max	100 m at 100 kHz
Channel separation	90° el ± 25° el
Dividing error	±50° el
Overvoltage protection	Available upon request

Encoder configuration

Type	XHI
Model	803 Standard
Shaft type	Ø25 mm through-going hollow shaft
Flange type	87-flange
Resolution	1024
Power supply	9-30 Vdc
Output signal	HTL
Connection type	Cable gland
Connecting direction	Adjustable
Cable gland dimension	M20 for Ø8-11 mm cables
Torque support	120 degrees torque bracket
Number of channels	6
Advanced Diagnostic System	Available upon request

Dimensions

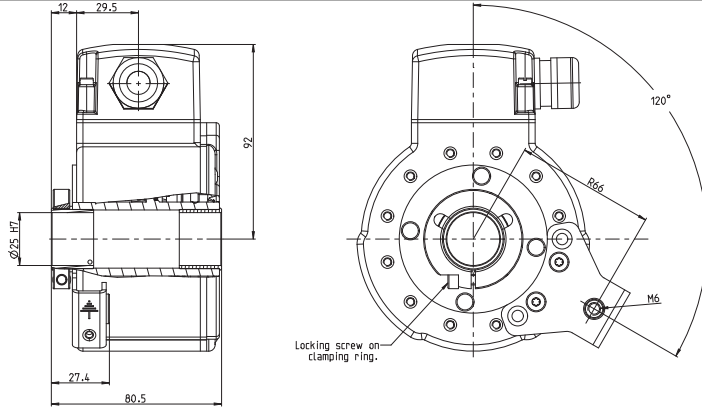

Output signals



Pin configuration

Function	Terminal
+E Volt	K
0 Volt	H
Sref	B
Sref inverted	A
S90	D
S90 inverted	C
S00	F
S00 inverted	E
Status	L
Shield	Case or G

Ordering information

Part number 750079-01