

- Single turn resolution ≤ 14 bit
- Robust design
- Shock and vibration protected



Technical data

Operating temperature	-40 °C .. +80 °C
Ingress protection class [IEC 60529]	IP67/IP66 (Encoder body/Shaft inlet)
Current consumption	50 mA at 24 Vdc
Vibration [IEC 60068-2-6]	≤ 300 m/s ²
Shock [IEC 60068-2-27]	≤ 2000 m/s ²
Cover material	Aluminium
Weight	300 g
Shaft load (axial/radial)	50 N / 60 N
Shaft material	Stainless steel
Rotational speed max	6000 rpm
Polarity protected	Yes

Encoder configuration

Type	RSA
Model	507 Singleturn
Shaft type	Ø10 with partial flat
Flange type	Clamping flange (61-type)
Resolution	13 bit singleturn
Power supply	9-36 Vdc
Output signal	SSI Binary
Connection type	Cable
Connecting direction	Radial
Cable length	4.00 m

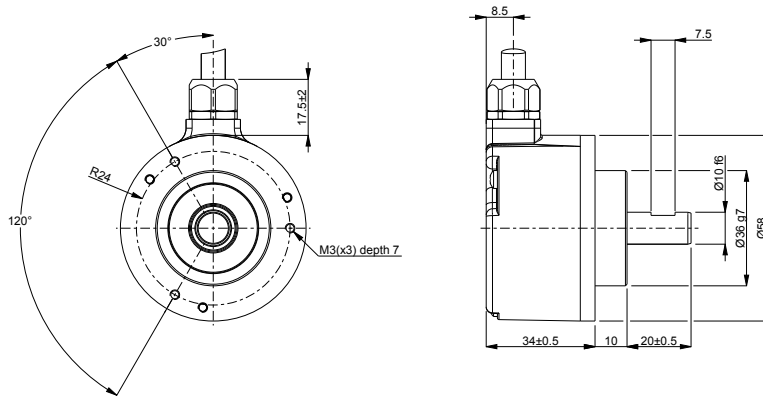
Dimensions**Output signals****Pin configuration**

Function	Color
Clock	Yellow
Clock inverted	Green
Data	White
Data inverted	Black
Hold	Brown
Code sequence	Violet
0 Volt	Blue
+E Volt	Red
Chassis	Shield

Ordering information

Part number

746092-01