

- Performance hollow shaft encoder for heavy duty industries
- Hybrid bearings for extended lifetime
- High vibration and shock resistance
- Electrically insulated shaft; up to 2,5 kV



Technical data

Operating temperature	-40 °C .. +100 °C
Ingress protection class [IEC 60529]	IP67 (IP66 at shaft inlet)
Vibration [IEC 60068-2-6]	≤ 200 m/s ²
Shock [IEC 60068-2-27]	≤ 1500 m/s ²
Cover material	Aluminium (coated)
Weight	1300 g
Shaft load (axial/radial)	100 N / 300 N
Rotational speed max	6000 rpm
Shaft material	Stainless steel with insulated hybrid bearings
Short circuit protected	Yes
Polarity protected	Yes
Current consumption	60 mA at 24 Vdc (Max. 80 mA)
Output load	± 40 mA
Output frequency max	200 kHz
Cable length max	100 m at 100 kHz
Channel separation	90° el ± 25° el
Dividing error	±50° el

Encoder configuration

Code key description	862107436
Type	XHI
Model	862
Shaft type	Ø12 mm blind hollow shaft
Flange type	86-flange
Resolution	100
Power supply	9-30 Vdc
Output signal	HTL
Connection type	Cable gland
Connecting direction	Radial
Cable gland dimension	M20 for Ø8-11 mm cables
Number of channels	6
Advanced Diagnostic System	Available upon request
Overvoltage protection	Yes
Torque bracket	120 degrees orientation

Dimensions

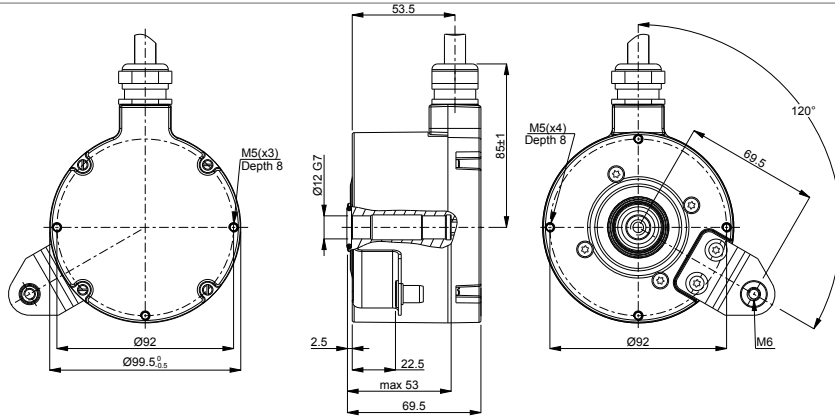

Output signals



Pin configuration

Function	Terminal
+E Volt	1
0 Volt	2
0 (Sref)	3
0 inverted (Sref\)	4
1 (S90)	5
1 inverted (S90\)	6
2 (S00)	7
2 inverted (S00\)	8
Shield	Chassis

Ordering information

Part number

739016-01