

- IP 67 encapsulation class
- Short-circuit protected electrical outputs
- Polarity protected power supply
- Shock and vibration protected
- 3 channel output and additional status output



Technical data

| | |
|--------------------------------------|------------------------------|
| Operating temperature | -40 °C .. +70 °C |
| Ingress protection class [IEC 60529] | IP67 |
| Vibration [IEC 60068-2-6] | ≤ 300 m/s ² |
| Shock [IEC 60068-2-27] | ≤ 5000 m/s ² |
| Cover material | Aluminium (anodized) |
| Weight | 70 g |
| Shaft load (axial/radial) | 10 N / 10 N |
| Rotational speed max | 6000 rpm |
| Shaft material | Stainless steel |
| Short circuit protected | Yes |
| Polarity protected | Yes |
| Current consumption | 10 mA at 24 Vdc (Max. 70 mA) |
| Output load | ±20 mA |
| Output frequency max | 200 kHz |
| Cable length max | 50 m at 50 kHz |
| Channel separation | 90° el ± 25° el |
| Dividing error | ±50° el |

Encoder configuration

| | |
|----------------------|-------------------------|
| Type | MSI |
| Model | 301 Extra robust |
| Shaft type | Ø6 mm with partial flat |
| Flange type | 31-flange |
| Resolution | 125 |
| Power supply | 9-36 Vdc |
| Output signal | HTL |
| Connection type | Cable |
| Connecting direction | Axial |
| Cable length | 3.00 m |

Dimensions

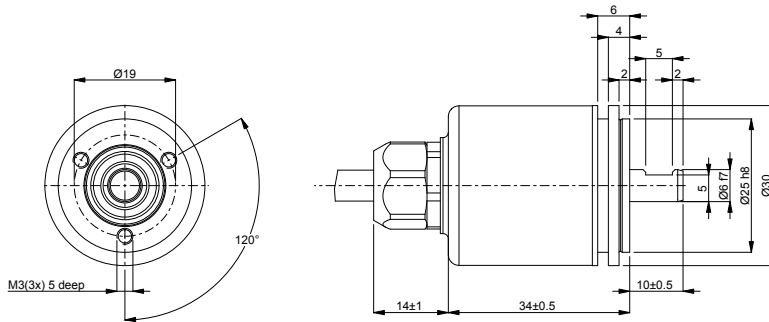

Output signals



Pin configuration

| Function | Colour |
|----------|--------|
| S00 | Yellow |
| S90 | Green |
| Sref | Brown |
| +EV | Red |
| 0V | Blue |
| Status | Grey |
| Chassis | Shield |

Ordering information

Part number 608530-23