

- IP 67 encapsulation class
- Short-circuit protected electrical outputs
- Polarity protected power supply
- Shock and vibration protected
- 3 channel output and additional status output



## Technical data

Operating temperature	-40 °C .. +70 °C
Ingress protection class [IEC 60529]	IP67
Vibration [IEC 60068-2-6]	≤ 300 m/s <sup>2</sup>
Shock [IEC 60068-2-27]	≤ 5000 m/s <sup>2</sup>
Cover material	Aluminium (anodized)
Weight	70 g
Shaft load (axial/radial)	10 N / 10 N
Rotational speed max	6000 rpm
Shaft material	Stainless steel
Short circuit protected	Yes
Polarity protected	Yes
Current consumption	10 mA at 24 Vdc (Max. 70 mA)
Output load	±20 mA
Output frequency max	200 kHz
Cable length max	50 m at 50 kHz
Channel separation	90° el ± 25° el
Dividing error	±50° el

## Encoder configuration

Type	MSI
Model	301 Extra robust
Shaft type	Ø6 mm with partial flat
Flange type	31-flange
Resolution	1000
Power supply	9-36 Vdc
Output signal	HTL
Connection type	Cable
Connecting direction	Axial
Cable length	2.00 m

## Dimensions

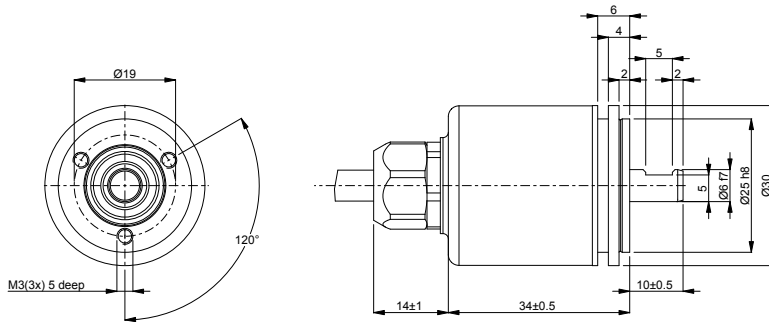

## Output signals



## Pin configuration

Function	Colour
S00	Yellow
S90	Green
Sref	Brown
+EV	Red
0V	Blue
Status	Grey
Chassis	Shield

## Ordering information

Part number 608530-14