**Ruggedized Shaft encoder, Absolute**

- 58mm diameter
- Single turn resolution 13 bit
- Multi turn resolution 12 bit
- Robust design
- Shock and vibration protected

**Technical data**

Operating temperature	-40 °C .. +70 °C
Ingress protection class [IEC 60529]	IP67/IP66 (Encoder body/Shaft inlet)
Current consumption	95 mA at 24 Vdc
Vibration [IEC 60068-2-6]	≤ 100 m/s <sup>2</sup>
Shock [IEC 60068-2-27]	≤ 1000 m/s <sup>2</sup>
Cover material	Aluminium
Weight	400 g
Shaft load (axial/radial)	50 N / 60 N
Shaft material	Stainless steel
Rotational speed max	12000 rpm
Polarity protected	Yes

**Encoder configuration**

Type	RSA
Model	608 Multiturn
Shaft type	Ø10 mm round
Flange type	Synchro flange (63-type)
Resolution	25 bit (13 bit singleturn + 12 bit multiturn)
Power supply	9-36 Vdc
Output signal	PROFIBUS DP
Connection type	Cable gland
Connecting direction	Radial

## Dimensions

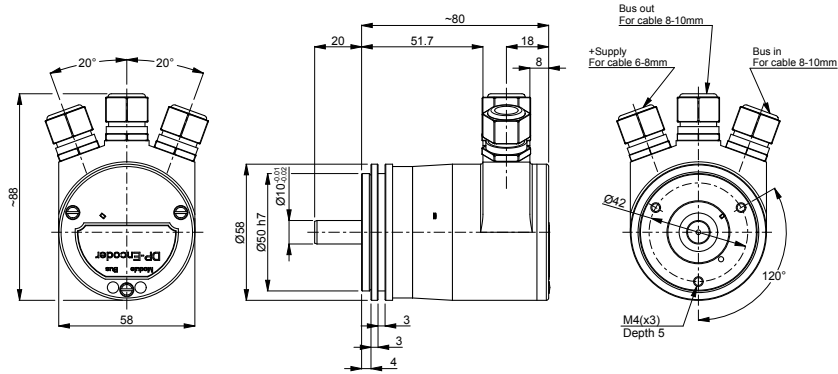

## Output signals

## Pin configuration

Function	Terminal
+E Volt	+
0 Volt	-
B** (Bus in)	B
A* (Bus in)	A
B** (Bus out)	B
A* (Bus out)	A

\*A terminals are connected  
\*\*B terminals are connected

## Ordering information

Part number

593918-01