

- Robust encoder with solid shaft
- Short-circuited protected outputs
- IP67 at housing, IP66 at shaft inlet



## Technical data

Operating temperature	-40 °C .. +70 °C
Ingress protection class [IEC 60529]	IP67 (IP66 at shaft inlet)
Vibration [IEC 60068-2-6]	≤ 300 m/s <sup>2</sup>
Shock [IEC 60068-2-27]	≤ 2000 m/s <sup>2</sup>
Cover material	Aluminium
Weight	300 g
Shaft load (axial/radial)	50 N / 60 N
Rotational speed max	6000 rpm
Shaft material	Stainless steel
Short circuit protected	Yes
Polarity protected	Yes
Current consumption	50 mA at 24 Vdc (Max. 75 mA)
Output load	± 40 mA
Output frequency max	300 kHz
Cable length max	100 m at 100 kHz
Channel separation	90° el ± 45° el
Dividing error	±90° el

## Encoder configuration

Type	RSI
Model	503 Standard
Shaft type	Ø10 mm round
Flange type	Clamping flange (61-type)
Resolution	8192
Power supply	9-30 Vdc
Output signal	HTL
Connection type	M12 connector 8-pin
Connecting direction	Radial

## Dimensions

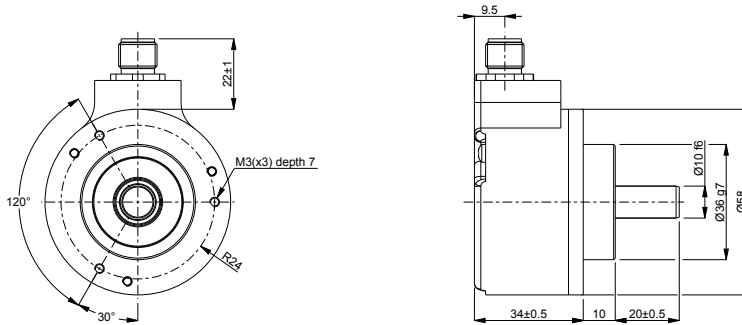

## Output signals



## Pin configuration

Function	Pin
S90 inverted	1
Sref	2
S90	3
S00	4
S00 inverted	5
Sref inverted	6
0V	7
+EV	8
Shield	Chassis

## Ordering information

Part number 588440-09