**Ruggedized Shaft encoder, Absolute**

- 58mm diameter
- Single turn resolution 13 bit
- Multi turn resolution 12 bit
- Robust design
- Shock and vibration protected

**Technical data**

Operating temperature	-40 °C .. +100 °C
Ingress protection class [IEC 60529]	IP67/IP66 (Encoder body/Shaft inlet)
Current consumption	Max 200 mA
Vibration [IEC 60068-2-6]	≤ 300 m/s ²
Shock [IEC 60068-2-27]	≤ 1000 m/s ²
Cover material	Aluminium
Weight	300 g
Shaft load (axial/radial)	40 N / 60 N
Shaft material	Stainless steel
Rotational speed max	12000 rpm
Polarity protected	No

Encoder configuration

Type	RSA
Model	608 Multiturn
Shaft type	Ø6 mm round
Flange type	Synchro flange (63-type)
Resolution	25 bit absolute + Incremental 512 ppr 1Vpp
Power supply	5 Vdc
Output signal	EnDat with additional incremental 1Vpp signals
Connection type	M23 connector 17-pin
Connecting direction	Radial

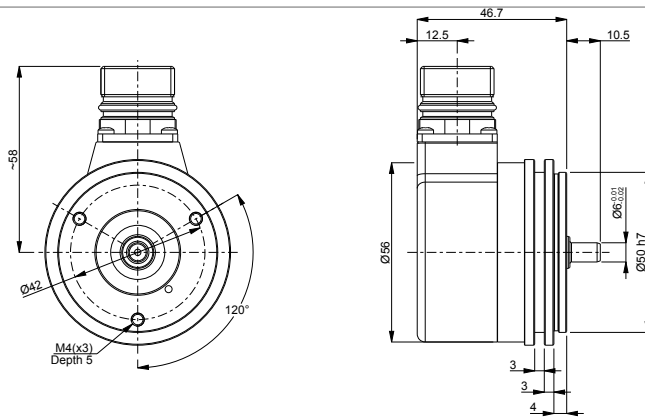
Dimensions**Output signals****Pin configuration**

Function	Pin / Colour
0 Volt	10 / White-Green
0V sense	4 / White
+E Volt	7 / Brown-Green
+EV sense	1 / Blue
A	15 / Green-Black
A inverted	16 / Yellow-Black
B	12 / Blue-Black
B inverted	13 / Red-Black
Data	14 / Grey
Data inverted	17 / Pink
Clock	8 / Violett
Clock inverted	9 / Yellow
Internal shield	11 / Internal shield
Chassis	Shield

Ordering information

Part number

576218-01