

- Robust encoder with solid shaft
- Short-circuited protected outputs
- IP67 at housing, IP66 at shaft inlet
- Dimensions according to imperial standards



Technical data

| | |
|--------------------------------------|----------------------------|
| Operating temperature | -40 °C .. +70 °C |
| Ingress protection class [IEC 60529] | IP67 (IP66 at shaft inlet) |
| Vibration [IEC 60068-2-6] | ≤ 300 m/s ² |
| Shock [IEC 60068-2-27] | ≤ 2000 m/s ² |
| Cover material | Aluminium |
| Weight | 300 g |
| Shaft load (axial/radial) | 50 N / 60 N |
| Rotational speed max | 6000 rpm |
| Shaft material | Stainless steel |
| Short circuit protected | Yes |
| Polarity protected | No |
| Current consumption | 45 mA (Max. 75 mA) |
| Output load | ± 20 mA |
| Output frequency max | 300 kHz |
| Cable length max | 50 m at 50 kHz |
| Channel separation | 90° el ± 25° el |
| Dividing error | ±50° el |

Encoder configuration

| | |
|----------------------|---------------------------|
| Type | RSI |
| Model | 505 Imperial measurements |
| Shaft type | Ø3/8 inch round (9.52 mm) |
| Flange type | Square flange (65-type) |
| Resolution | 5000 |
| Power supply | 5 Vdc |
| Output signal | TTL |
| Connection type | MS connector 10-pin |
| Connecting direction | Radial |

Dimensions

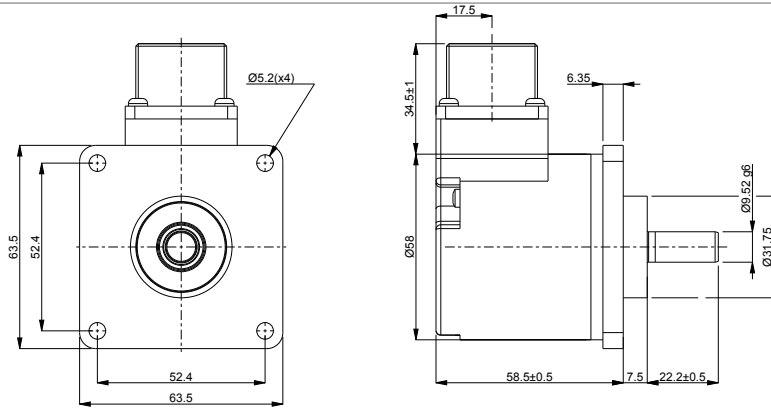

Output signals



Pin configuration

| Function | Pin |
|---------------|--------|
| S00 | A |
| S90 | B |
| Sref | C |
| +EV | D |
| +EV Sensor | E |
| 0V | F |
| S00 inverted | G |
| S90 inverted | H |
| Sref inverted | I |
| Chassis | Shield |

Ordering information

Part number

537838-08