

- Robust encoder with solid shaft
- Short-circuited protected outputs
- IP67 at housing, IP66 at shaft inlet



Technical data

Operating temperature	-40 °C .. +70 °C
Ingress protection class [IEC 60529]	IP67 (IP66 at shaft inlet)
Vibration [IEC 60068-2-6]	≤ 300 m/s ²
Shock [IEC 60068-2-27]	≤ 2000 m/s ²
Cover material	Aluminium
Weight	300 g
Shaft load (axial/radial)	50 N / 60 N
Rotational speed max	6000 rpm
Shaft material	Stainless steel
Short circuit protected	Yes
Polarity protected	No
Current consumption	45 mA (Max. 75 mA)
Output load	± 20 mA
Output frequency max	300 kHz
Cable length max	50 m at 50 kHz
Channel separation	90° el ± 25° el
Dividing error	±50° el

Encoder configuration

Type	RSI
Model	503 Standard
Shaft type	Ø6 mm round
Flange type	51-flange
Resolution	8
Power supply	5 Vdc
Output signal	TTL
Connection type	Cable
Connecting direction	Radial
Cable length	1.50 m

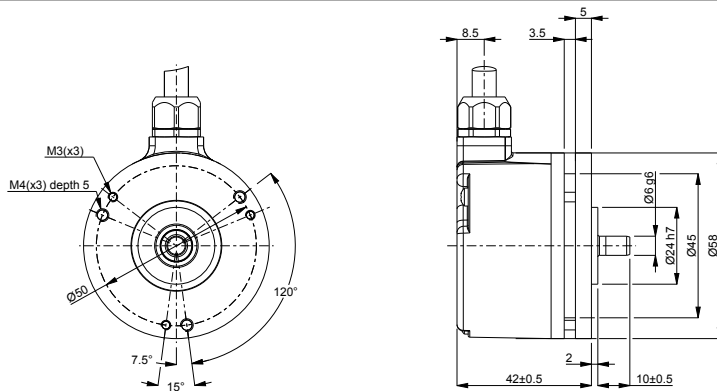
Dimensions**Output signals****Pin configuration**

Function	Colour
S00	Yellow
S00 inverted	Black
S90	Green
S90 inverted	White
Sref	Brown
Sref inverted	Violet
+E Volt	Red
0V	Blue
Status	Grey
Chassis	Shield

Ordering information

Part number

534714-05