

- Robust $\varnothing 58$ mm encoder with solid shaft
- Short-circuited protected outputs
- IP67 at housing, IP66 at shaft inlet
- Extra robust electronics



Technical data

Operating temperature	-40 °C .. +70 °C
Ingress protection class [IEC 60529]	IP67 (IP66 at shaft inlet)
Vibration [IEC 60068-2-6]	≤ 300 m/s ²
Shock [IEC 60068-2-27]	≤ 2000 m/s ²
Cover material	Aluminium
Weight	300 g
Shaft load (axial/radial)	100 N / 120 N
Rotational speed max	3000 rpm
Shaft material	Stainless steel
Short circuit protected	Yes
Polarity protected	Yes
Current consumption	55 mA at 24 Vdc (Max. 80 mA)
Output load	± 40 mA
Output frequency max	200 kHz
Cable length max	350 m at 100 kHz
Channel separation	90° el $\pm 25^\circ$ el
Dividing error	$\pm 50^\circ$ el

Encoder configuration

Type	RSI
Model	501 Extra robust
Shaft type	$\varnothing 10$ with partial flat
Flange type	51-flange
Resolution	5000
Power supply	9-36 Vdc
Output signal	HC-HTL
Connection type	Cable
Connecting direction	Radial
Cable length	5.00 m

Dimensions

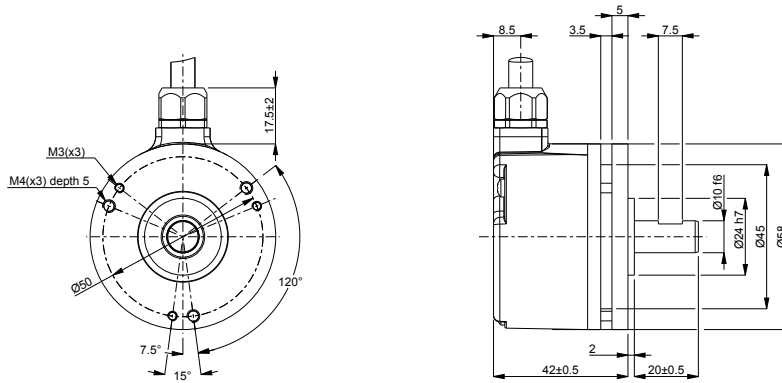

Output signals



Pin configuration

Function	Colour
S00	Yellow
S90	Green
+EV	Red
0V	Blue
Chassis	Shield

Ordering information

Part number

528556-06