

- Robust Ø58 mm encoder with hollow shaft
- Short-circuited protected outputs
- IP67 at housing, IP66 at shaft inlet



## Technical data

|                                      |                              |
|--------------------------------------|------------------------------|
| Operating temperature                | -40 °C .. +70 °C             |
| Ingress protection class [IEC 60529] | IP67 (IP66 at shaft inlet)   |
| Vibration [IEC 60068-2-6]            | ≤ 300 m/s <sup>2</sup>       |
| Shock [IEC 60068-2-27]               | ≤ 2000 m/s <sup>2</sup>      |
| Cover material                       | Aluminium                    |
| Weight                               | 300 g                        |
| Shaft load (axial/radial)            | 10 N / 20 N                  |
| Rotational speed max                 | 6000 rpm                     |
| Shaft material                       | Stainless steel              |
| Short circuit protected              | Yes                          |
| Polarity protected                   | Yes                          |
| Current consumption                  | 50 mA at 24 Vdc (Max. 75 mA) |
| Output load                          | ±40 mA                       |
| Output frequency max                 | 300 kHz                      |
| Cable length max                     | 100 m at 100 kHz             |
| Channel separation                   | 90° el ± 25° el              |
| Dividing error                       | ±50° el                      |

## Encoder configuration

|                      |                                   |
|----------------------|-----------------------------------|
| Type                 | RHI                               |
| Model                | 503 Standard                      |
| Shaft type           | Ø12 mm blind hollow shaft         |
| Flange type          | 58/59-flange with stator coupling |
| Resolution           | 5000                              |
| Power supply         | 9-30 Vdc                          |
| Output signal        | HTL                               |
| Connection type      | Cable                             |
| Connecting direction | Radial                            |
| Cable length         | 1.50 m                            |

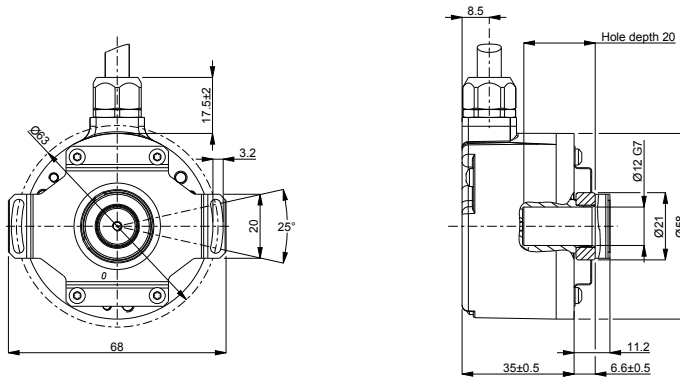
**Dimensions****Output signals****Pin configuration**

| Function      | Colour |
|---------------|--------|
| S00           | Yellow |
| S00 inverted  | Black  |
| S90           | Green  |
| S90 inverted  | White  |
| Sref          | Brown  |
| Sref inverted | Violet |
| +E Volt       | Red    |
| 0V            | Blue   |
| Status        | Grey   |
| Chassis       | Shield |

**Ordering information**

Part number

521661-13