

- Robust Ø58 mm encoder with hollow shaft
- Short-circuited protected outputs
- IP67 at housing, IP66 at shaft inlet



## Technical data

|                                      |                              |
|--------------------------------------|------------------------------|
| Operating temperature                | -40 °C .. +70 °C             |
| Ingress protection class [IEC 60529] | IP67 (IP66 at shaft inlet)   |
| Vibration [IEC 60068-2-6]            | ≤ 300 m/s <sup>2</sup>       |
| Shock [IEC 60068-2-27]               | ≤ 2000 m/s <sup>2</sup>      |
| Cover material                       | Aluminium                    |
| Weight                               | 300 g                        |
| Shaft load (axial/radial)            | 10 N / 20 N                  |
| Rotational speed max                 | 6000 rpm                     |
| Shaft material                       | Stainless steel              |
| Short circuit protected              | Yes                          |
| Polarity protected                   | Yes                          |
| Current consumption                  | 50 mA at 24 Vdc (Max. 75 mA) |
| Output load                          | ± 40 mA                      |
| Output frequency max                 | 300 kHz                      |
| Cable length max                     | 100 m at 100 kHz             |
| Channel separation                   | 90° el ± 25° el              |
| Dividing error                       | ±50° el                      |

## Encoder configuration

|                      |                                   |
|----------------------|-----------------------------------|
| Type                 | RHI                               |
| Model                | 503 Standard                      |
| Shaft type           | Ø12 mm through-going hollow shaft |
| Flange type          | 56/57-flange                      |
| Resolution           | 2500                              |
| Power supply         | 9-30 Vdc                          |
| Output signal        | HTL                               |
| Connection type      | PT connector 8-pin                |
| Connecting direction | Radial                            |

## Dimensions

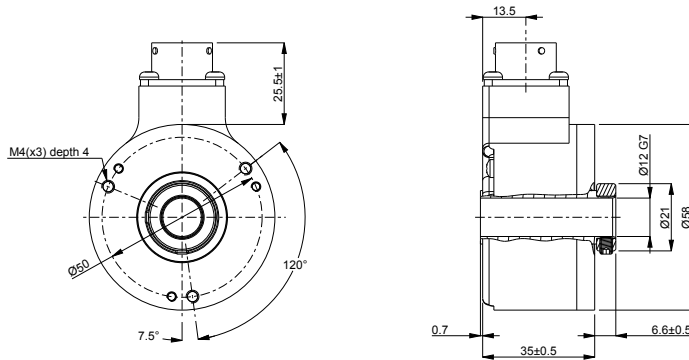

## Output signals



## Pin configuration

| Function      | Pin |
|---------------|-----|
| S90           | A   |
| S90 inverted  | B   |
| S00 inverted  | C   |
| S00           | D   |
| +EV           | E   |
| 0V            | F   |
| Sref          | G   |
| Sref inverted | H   |

## Ordering information

Part number

516181-30