

- Robust encoder with solid shaft
- Short-circuited protected outputs
- IP67 at housing, IP66 at shaft inlet



## Technical data

Operating temperature	-40 °C .. +70 °C
Ingress protection class [IEC 60529]	IP67 (IP66 at shaft inlet)
Vibration [IEC 60068-2-6]	≤ 300 m/s <sup>2</sup>
Shock [IEC 60068-2-27]	≤ 2000 m/s <sup>2</sup>
Cover material	Aluminium
Weight	300 g
Shaft load (axial/radial)	50 N / 60 N
Rotational speed max	6000 rpm
Shaft material	Stainless steel
Short circuit protected	Yes
Polarity protected	No
Current consumption	45 mA (Max. 75 mA)
Output load	± 20 mA
Output frequency max	300 kHz
Cable length max	50 m at 50 kHz
Channel separation	90° el ± 25° el
Dividing error	±50° el

## Encoder configuration

Type	RSI
Model	503 Standard
Shaft type	Ø10 with partial flat
Flange type	52-flange
Resolution	500
Power supply	5 Vdc
Output signal	TTL
Connection type	MS connector 10-pin
Connecting direction	Axial

## Dimensions

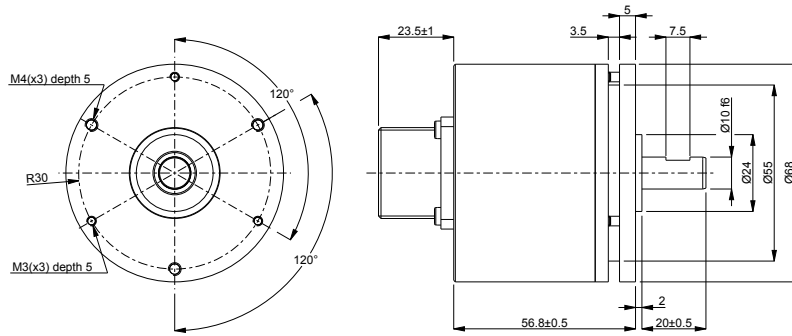

## Output signals



## Pin configuration

Function	Pin
S90	A
S90 inverted	B
S00 inverted	C
S00	D
+EV	E
0V	F
Sref	G
Sref inverted	H
Status	I

## Ordering information

Part number 507729-13