

- Robust encoder with solid shaft
- Short-circuited protected outputs
- IP67 at housing, IP66 at shaft inlet



Technical data

| | |
|--------------------------------------|------------------------------|
| Operating temperature | -40 °C .. +70 °C |
| Ingress protection class [IEC 60529] | IP67 (IP66 at shaft inlet) |
| Vibration [IEC 60068-2-6] | ≤ 300 m/s ² |
| Shock [IEC 60068-2-27] | ≤ 2000 m/s ² |
| Cover material | Aluminium |
| Weight | 300 g |
| Shaft load (axial/radial) | 50 N / 60 N |
| Rotational speed max | 6000 rpm |
| Shaft material | Stainless steel |
| Short circuit protected | Yes |
| Polarity protected | Yes |
| Current consumption | 50 mA at 24 Vdc (Max. 75 mA) |
| Output load | ± 40 mA |
| Output frequency max | 300 kHz |
| Cable length max | 100 m at 100 kHz |
| Channel separation | 90° el ± 25° el |
| Dividing error | ±50° el |

Encoder configuration

| | |
|----------------------|-----------------------|
| Type | RSI |
| Model | 503 Standard |
| Shaft type | Ø10 with partial flat |
| Flange type | 51-flange |
| Resolution | 1024 |
| Power supply | 9-30 Vdc |
| Output signal | HTL |
| Connection type | PT connector 8-pin |
| Connecting direction | Axial |

Dimensions

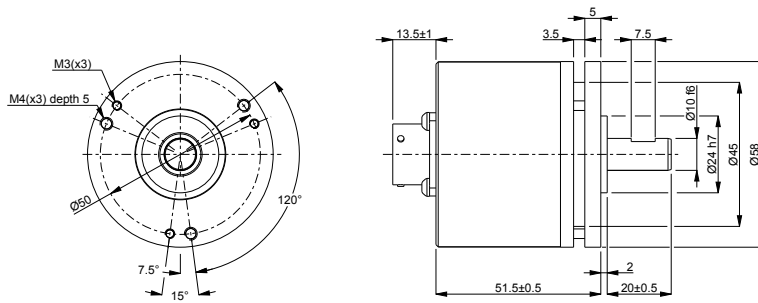

Output signals



Pin configuration

| Function | Pin |
|---------------|-----|
| S90 | A |
| S90 inverted | B |
| S00 inverted | C |
| S00 | D |
| +EV | E |
| 0V | F |
| Sref | G |
| Sref inverted | H |

Ordering information

Part number 507566-01