

- Single turn resolution ≤ 10 bit
- Robust design
- Shock and vibration protected



Technical data

Operating temperature	-40 °C .. +80 °C
Ingress protection class [IEC 60529]	IP67/IP66 (Encoder body/Shaft inlet)
Current consumption	90 mA
Vibration [IEC 60068-2-6]	≤ 300 m/s ²
Shock [IEC 60068-2-27]	≤ 2000 m/s ²
Cover material	Aluminium
Weight	300 g
Shaft load (axial/radial)	50 N / 60 N
Shaft material	Stainless steel
Rotational speed max	6000 rpm
Polarity protected	No

Encoder configuration

Type	RSA
Model	506 Singleturn
Shaft type	Ø10 mm round
Flange type	Synchro flange (63-type)
Resolution	10 bit singleturn
Power supply	5 Vdc
Output signal	Parallel Gray
Connection type	Cable
Connecting direction	Radial
Cable length	1.50 m

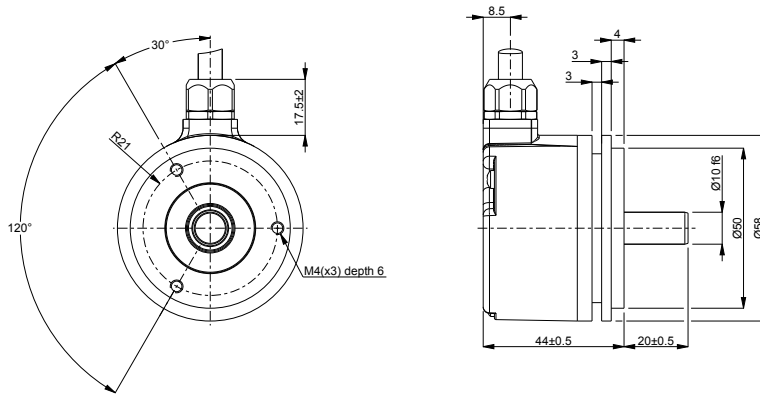
Dimensions**Output signals****Pin configuration**

Function	Colour
+E Volt	Red
0 Volt	Blue
Bit 1	White
Bit 2	Brown
Bit 3	Green
Bit 4	Yellow
Bit 5	Grey
Bit 6	Pink
Bit 7	Black
Bit 8	Violet
Bit 9	Grey/Pink
Bit 10	Blue/Red
Code sequence	White/Yellow
/Hold	Brown/Yellow
Chassis	Shield

Ordering information

Part number

1081187-02