

775 42

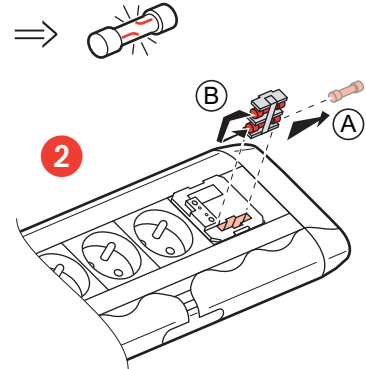

775 41

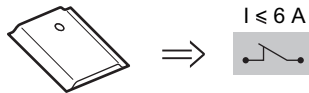
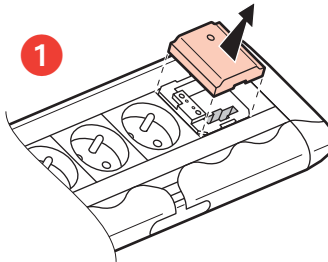
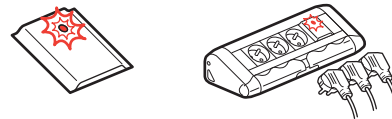
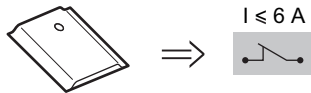
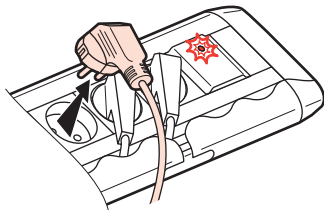
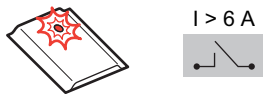
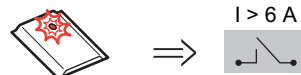
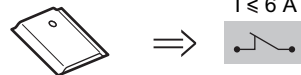
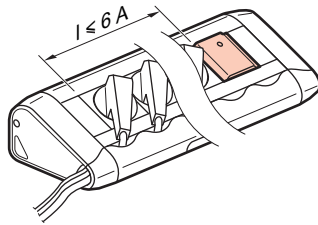
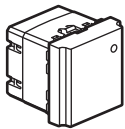
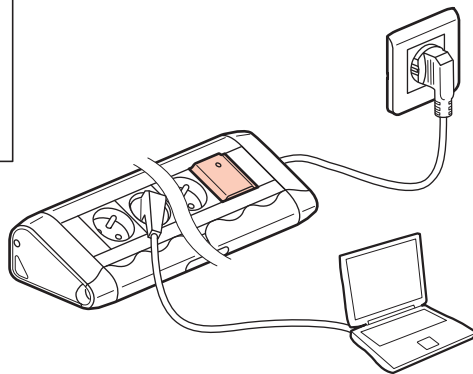

230 V~ TT, TNS
Icc max : 4,5 kA

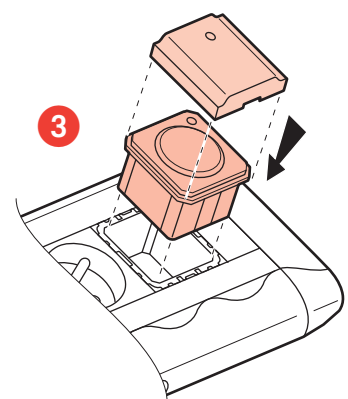
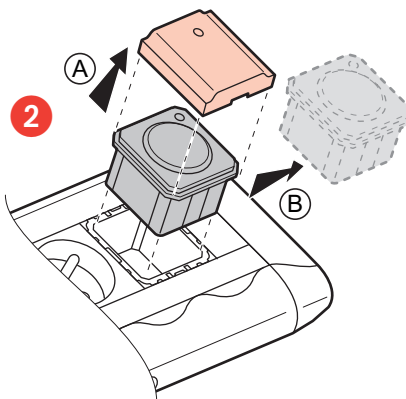
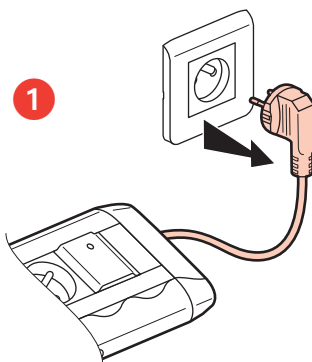
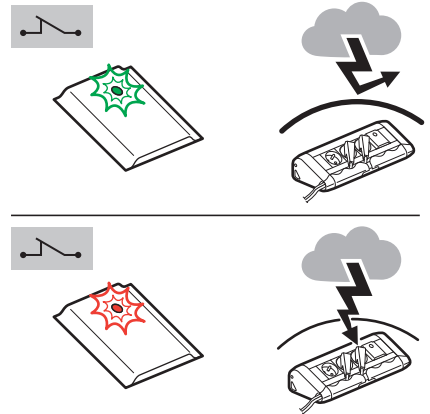

FR (LU) (BE) Avant toute intervention, couper le courant.
Respecter strictement les conditions d'installation et d'utilisation.

NL (BE) Onderbreek voor enige ingreep de stroom.
Neem de installatie- en gebruiksvoorwaarden nauwgezet in acht.

GB (IE) Make sure the power supply is disconnected before any intervention.
Strictly comply with instructions for installation and use.

DE (AT) (LI) Vor jeglichem Eingriff die Spannungsfreiheit sicherstellen.
Einbau- und Gebrauchsanleitungen sind genau zu beachten.

ES Antes de cualquier intervención, cortar la corriente.
Respetar estrictamente las condiciones de instalación y de utilización.

IT Prima di qualsiasi intervento, interrompere l'alimentazione.
Rispettare scrupolosamente le condizioni d'installazione e uso.

PT Antes de qualquer intervenção, cortar a corrente.
Respeitar estritamente as condições de instalação e de utilização.

GR (CY) Πριν από οποιαδήποτε επέμβαση, κόψτε το ρεύμα.
Τηρείτε αυστηρά τις συνθήκες εγκατάστασης και χρήσης.

PL Przed każdą operacją na urządzeniu, odłączyć dopływ prądu.
Ścisłe przestrzegać instrukcji dotyczących instalacji i użytkowania.

TR (CY) Herhangi bir müdahaleden önce, akımı kesiniz.
Yerleştirme ve kullanım koşullarına titizlikle riayet ediniz.

HU Minden beavatkozás előtt szakítsa meg az áramellátást.
Tartsa be pontosan a beszerelési és használati feltételeket.

FI Ennen huolttoa, katkaise virta. Noudata asennus- ja käyttöohjeita tarkoin.

SE Innan allt ingrepp, stäng av strömförsörjningen.
Iaktta noggrant installations- och användningsföreskrifterna.

CZ Před jakýmkoliv zásahem vypněte proud.
Důsledně dodržujte instalační a uživatelské podmínky.

SK Pred akýmkoľvek zásahom odpojte napájanie.
Prísne dodržiavajte podmienky, za ktorých sa má prístroj inštalovať a používať.

SI Pred vsakim posegom izključite električno napajanje.
Natančno upoštevajte pogoje za montažo in uporabo.

DK Inden der foretages et hvilket som helst indgreb, skal strømmen afbrydes.
Installations- og anvendelsesbetingelserne skal overholdes nøje.

MT L-ewwel u qabel kollox, ifi l-kurrent tad-dawl mill-mejn.
Imxi skond l-istruzzjonijiet mogħtija għall-istallazzjoni u l-użu.

EE Enne mistahes (hooldus) tööd eemaldage vooluvõrgust.
Pidage täpselt kinni paigaldus-ja kasutamistingimustest.

LV Pārtraukt strāvas padevi pirms izaukšanas.
Stingri ievērot uzstādīšanas un lietošanas noteikumus.

LT Prieš atlikdami bet kokius veiksmus, išjunkite prietaisą iš elektros tinklo.
Griežtai laikytis instalavimo ir naudojimo sąlygų.

NO Bryt strømtilførselen for ethvert ingrepp.
Installasjons- og bruksbetingelsene må nøye overholdes.

IS Loka barf fyrir straum áður en átt er við tækið.
Fylgja skal vandlega öllum reglum um uppsetningu og notkun.