

208 84/85

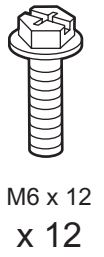

2b / 3b

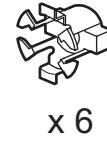

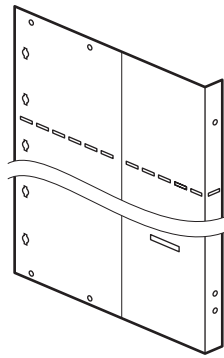
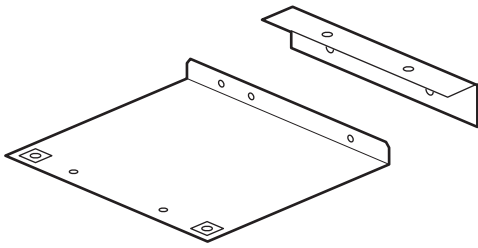
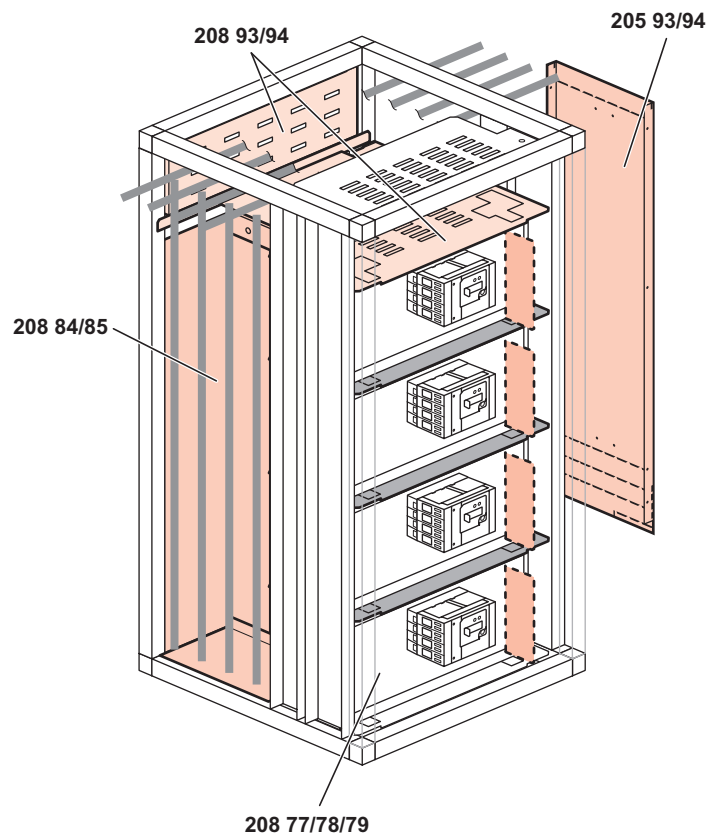
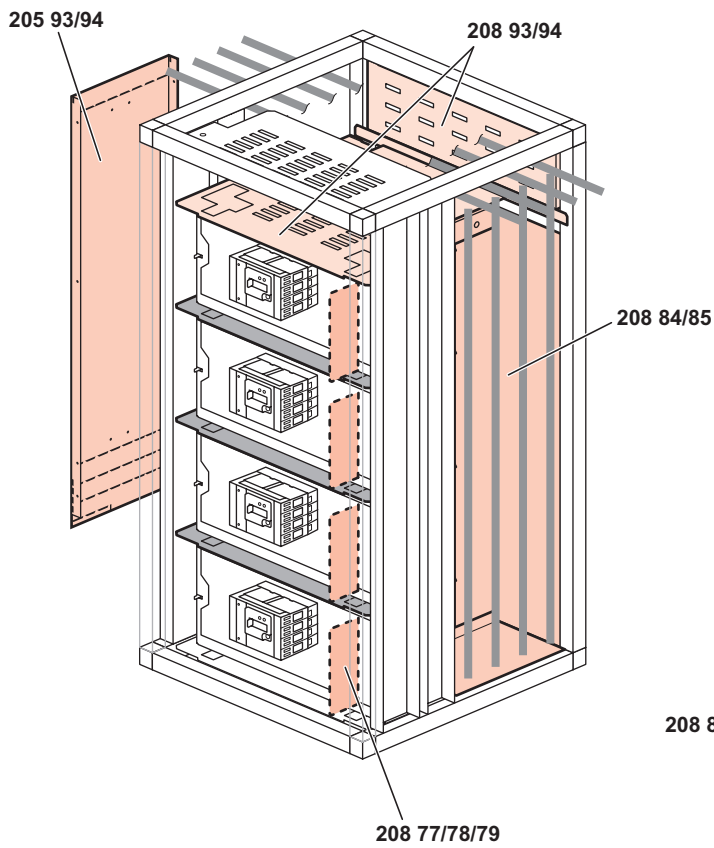
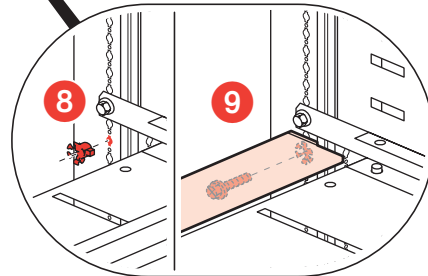
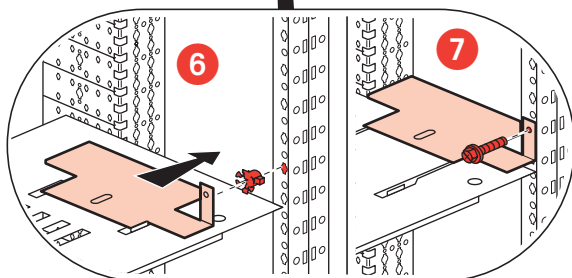
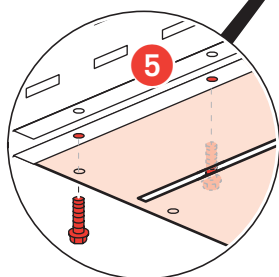
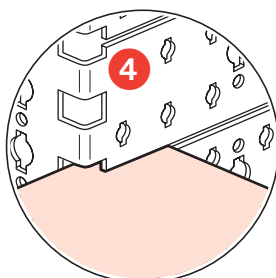
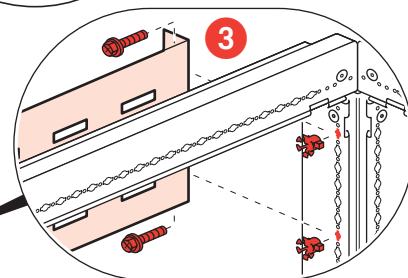
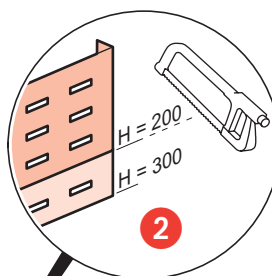
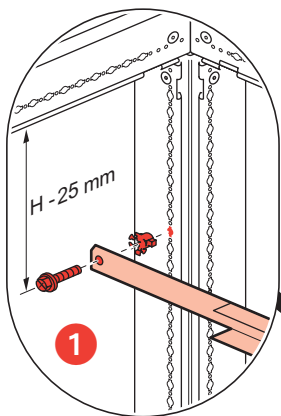
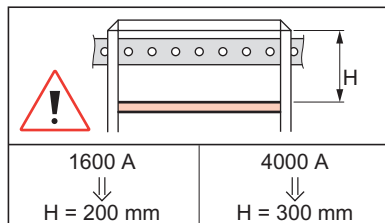
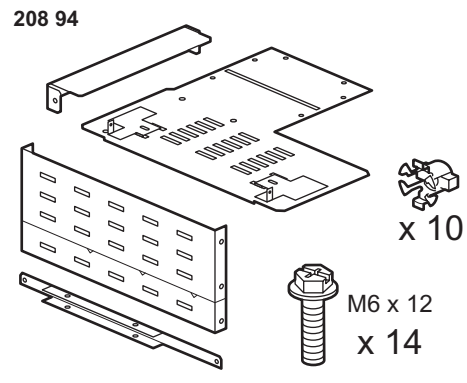
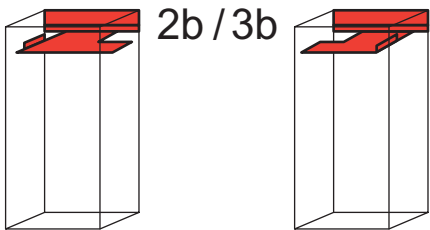

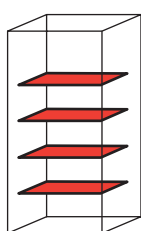
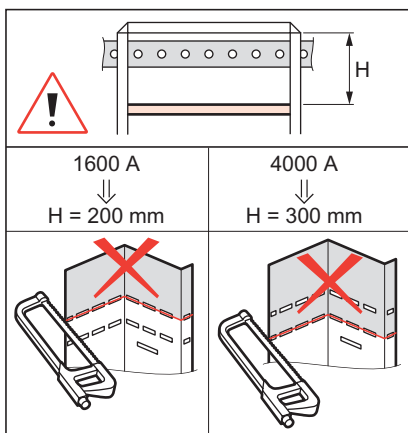
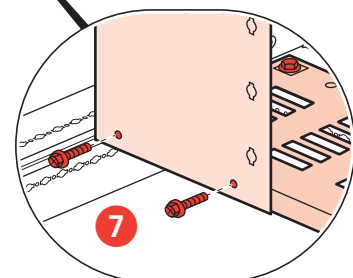
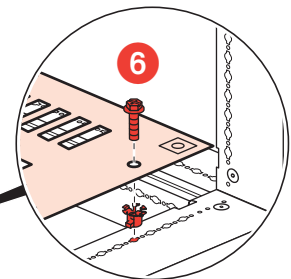
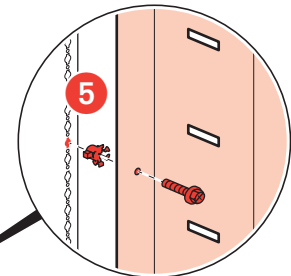
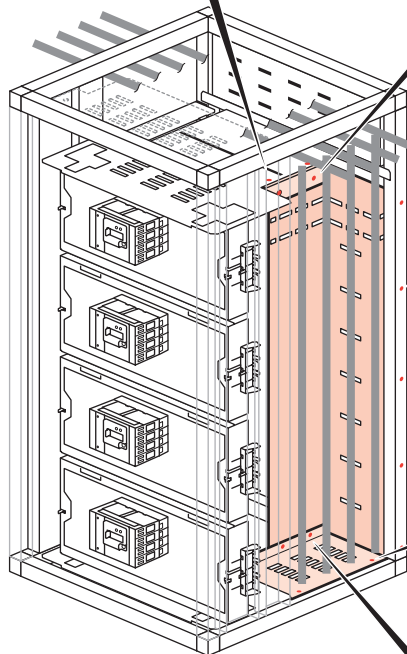
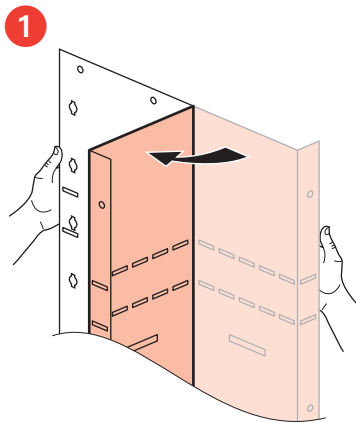
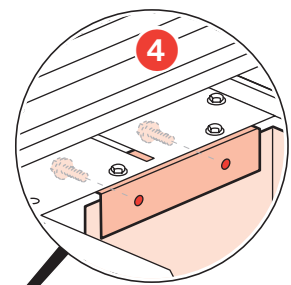
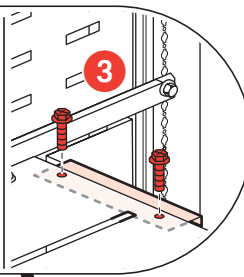
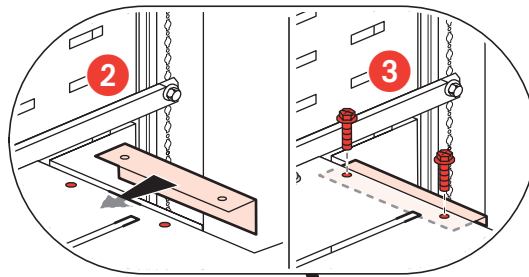
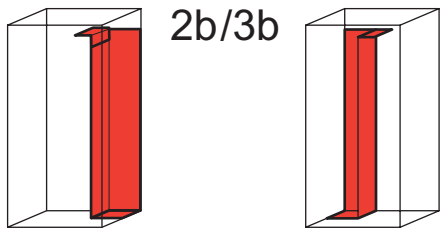

3b

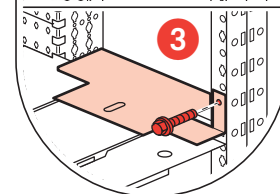
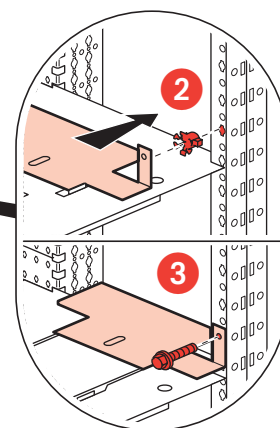
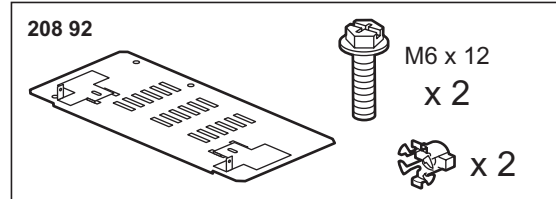
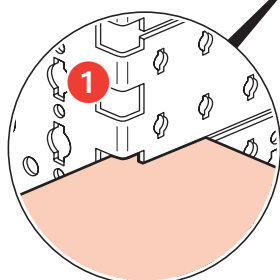
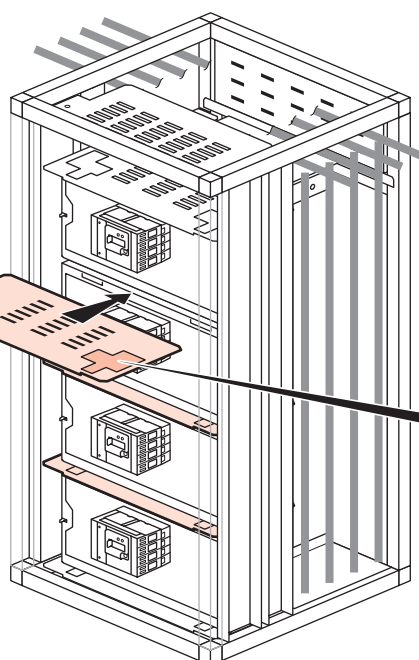

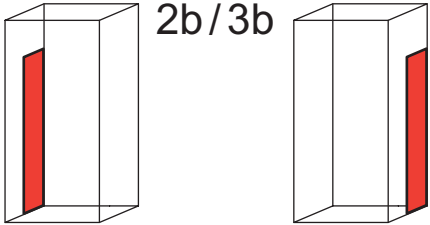

2b/3b

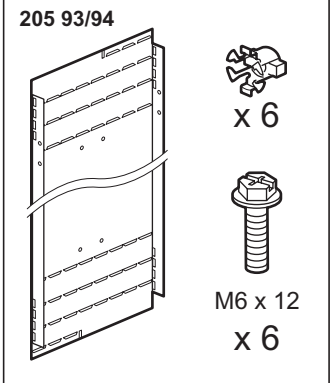
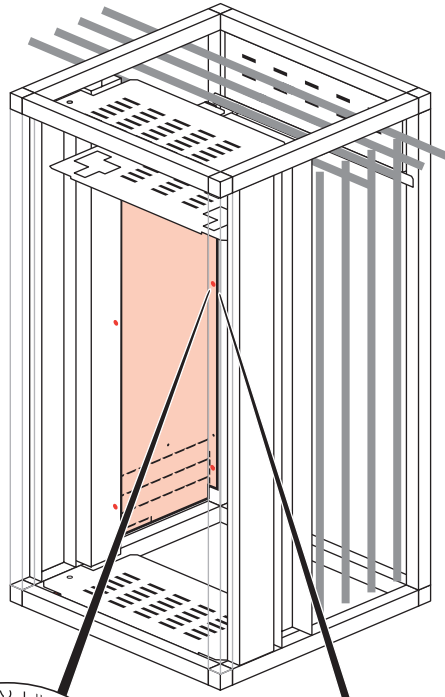

205 93/94

x 6

M6 x 12
x 6

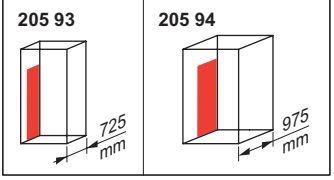
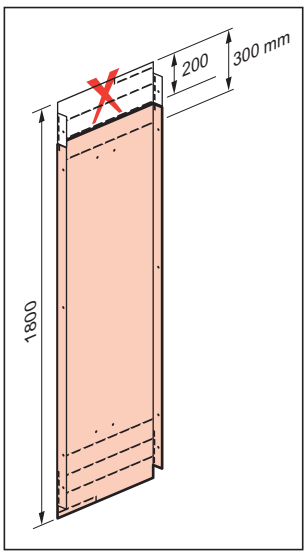

205 93

725 mm

205 94

975 mm

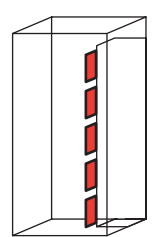
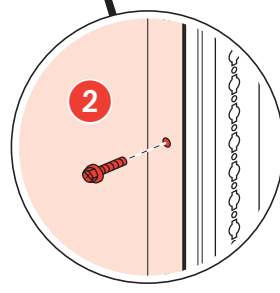
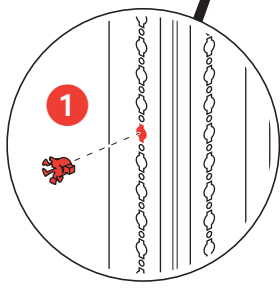

2b/3b

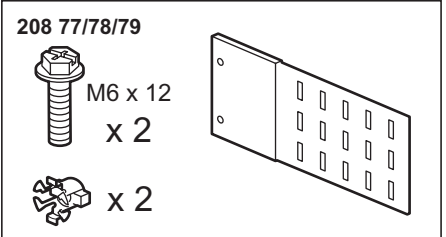
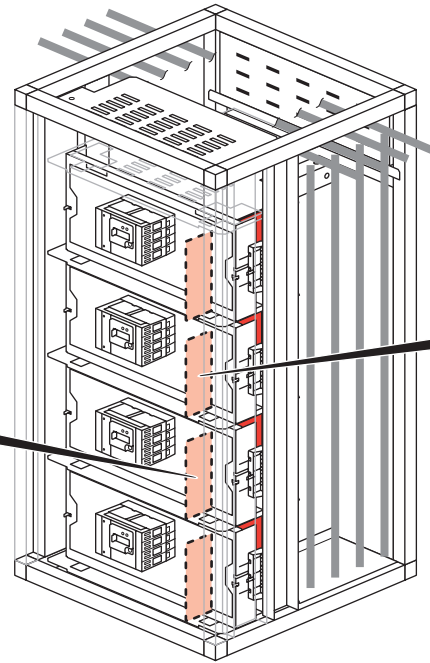

208 77/78/79

M6 x 12
x 2

x 2

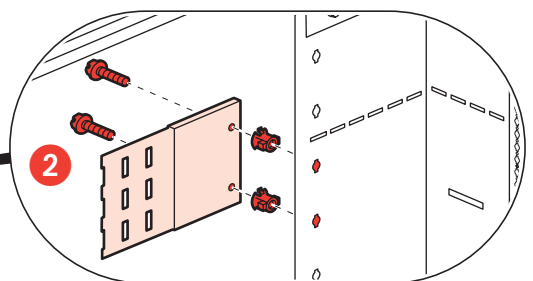
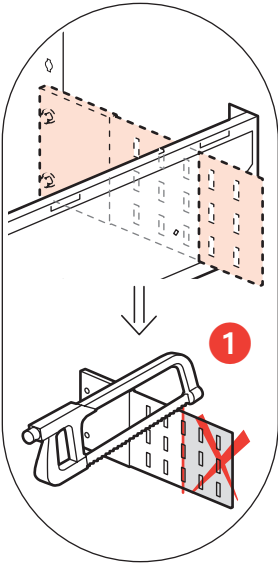

	H (mm)	
	200	208 77
	300	208 78
	400	208 79