

202 34 - 206 34 DPX 250ER

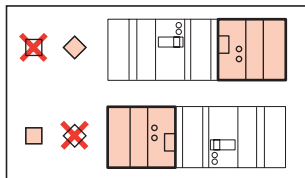

4P		
2◇ ■ 2	2◇ ■ 2	2◇ ■ 2
2◇ □ 2	2◇ □ 2	2◇ □ 2
2◇ ■ 2	2◇ ■ 2	2◇ ■ 2

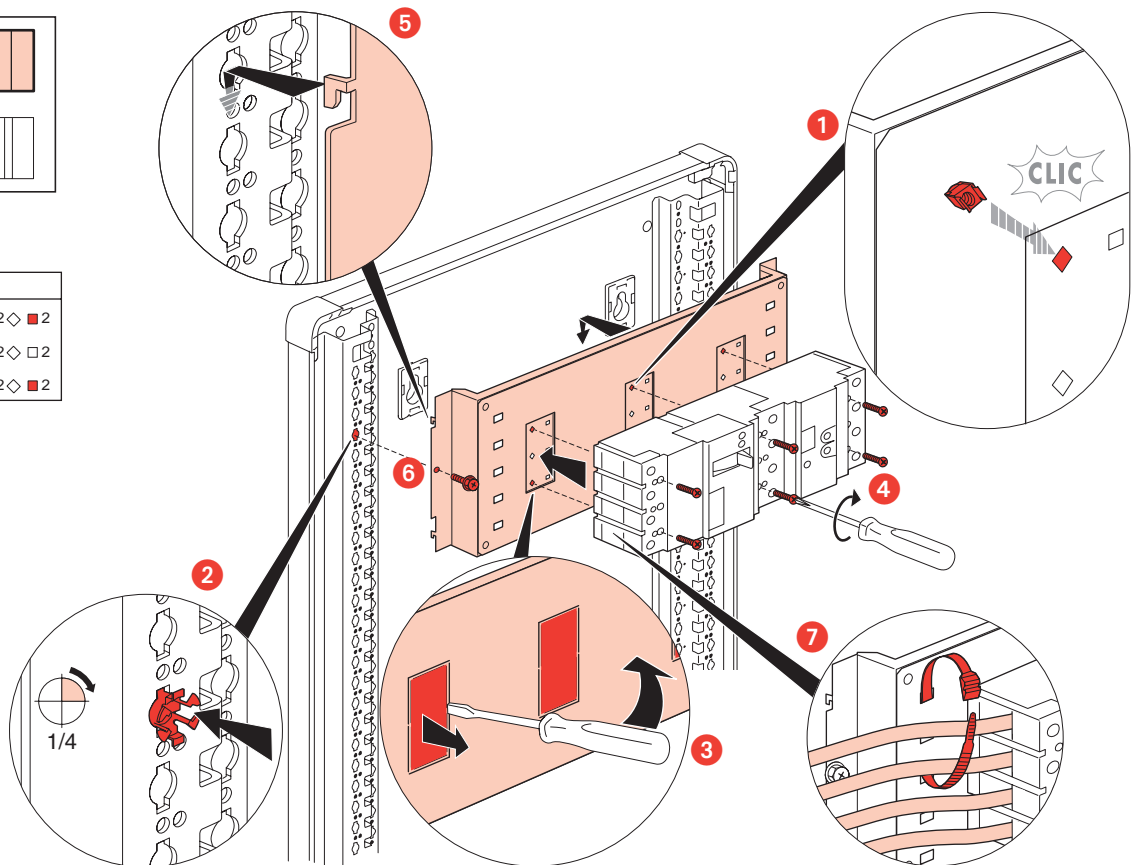

202 35 DPX 250 ER
 202 36/37 DPX 630
 206 36/37 DPX 630

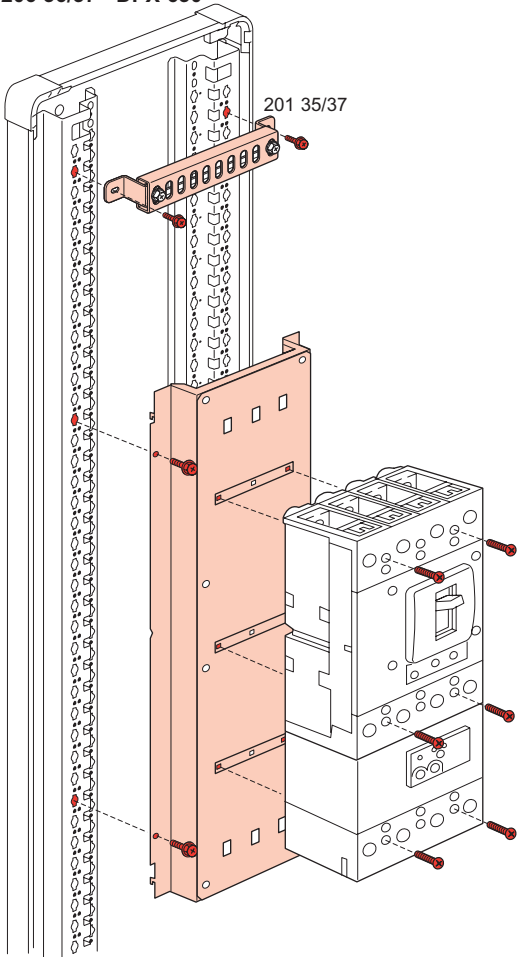



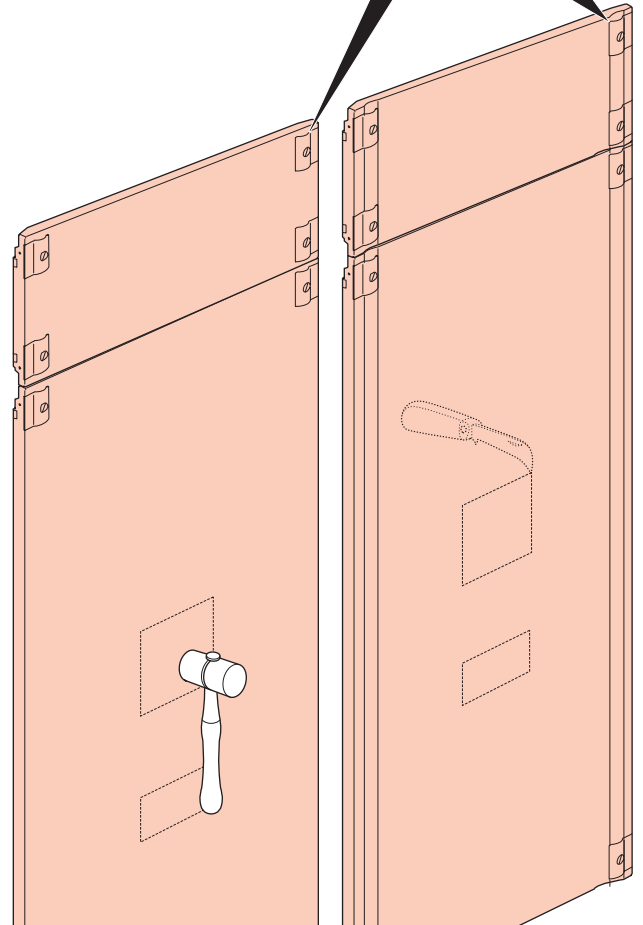
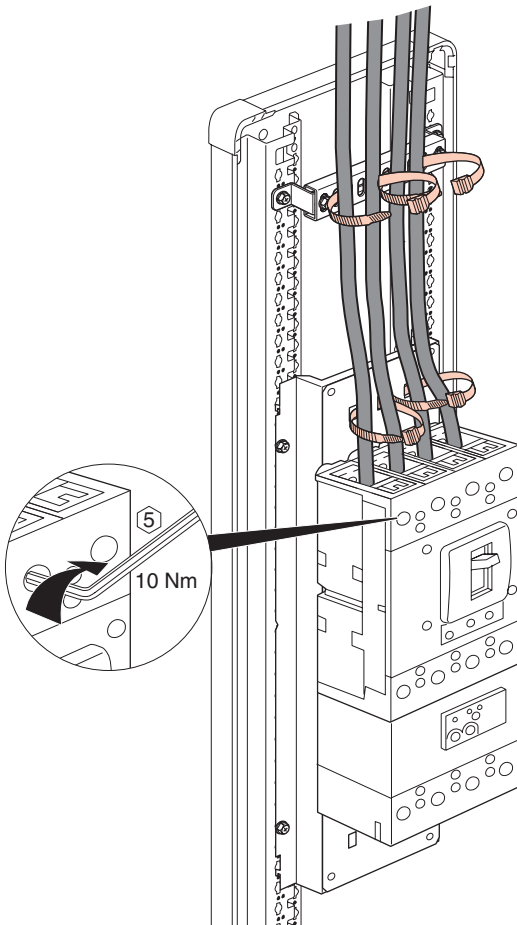
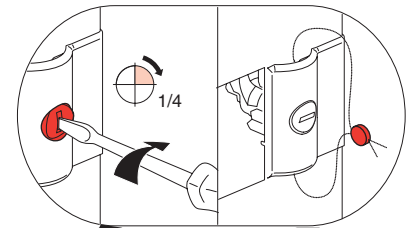
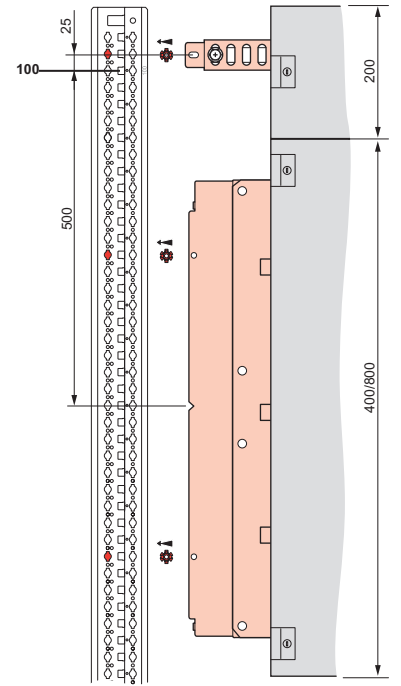



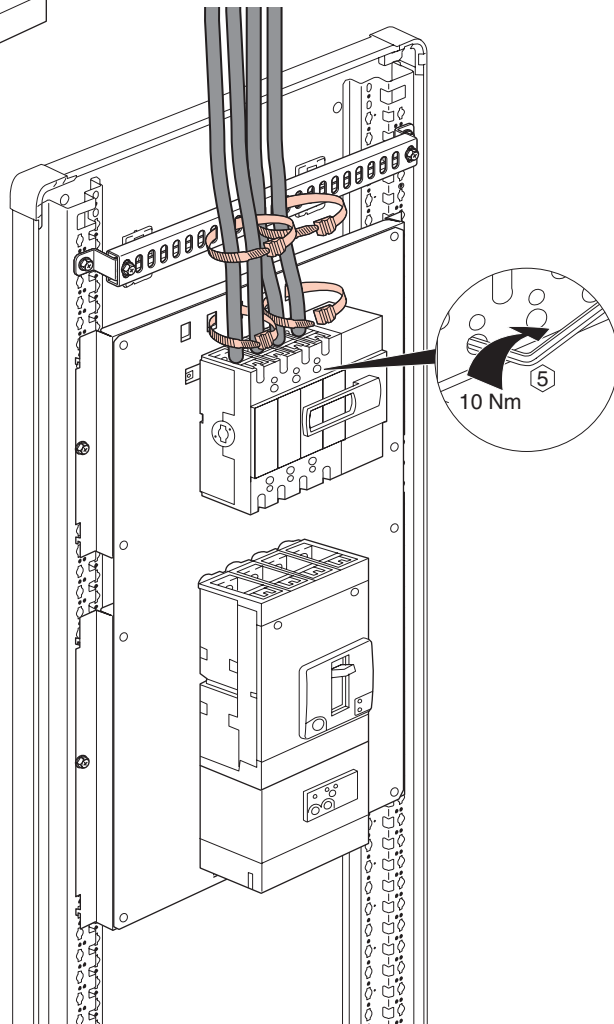
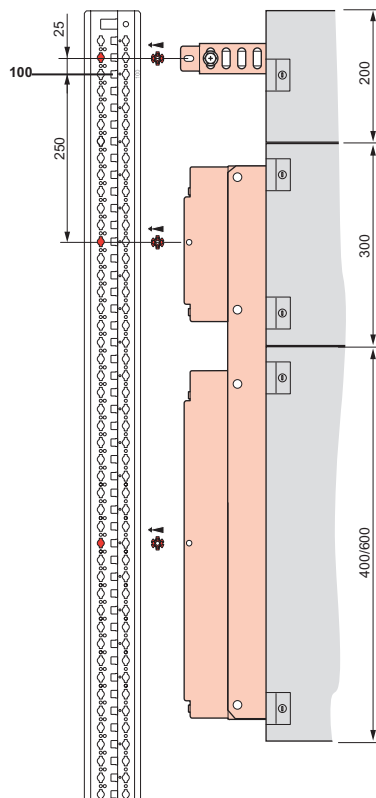
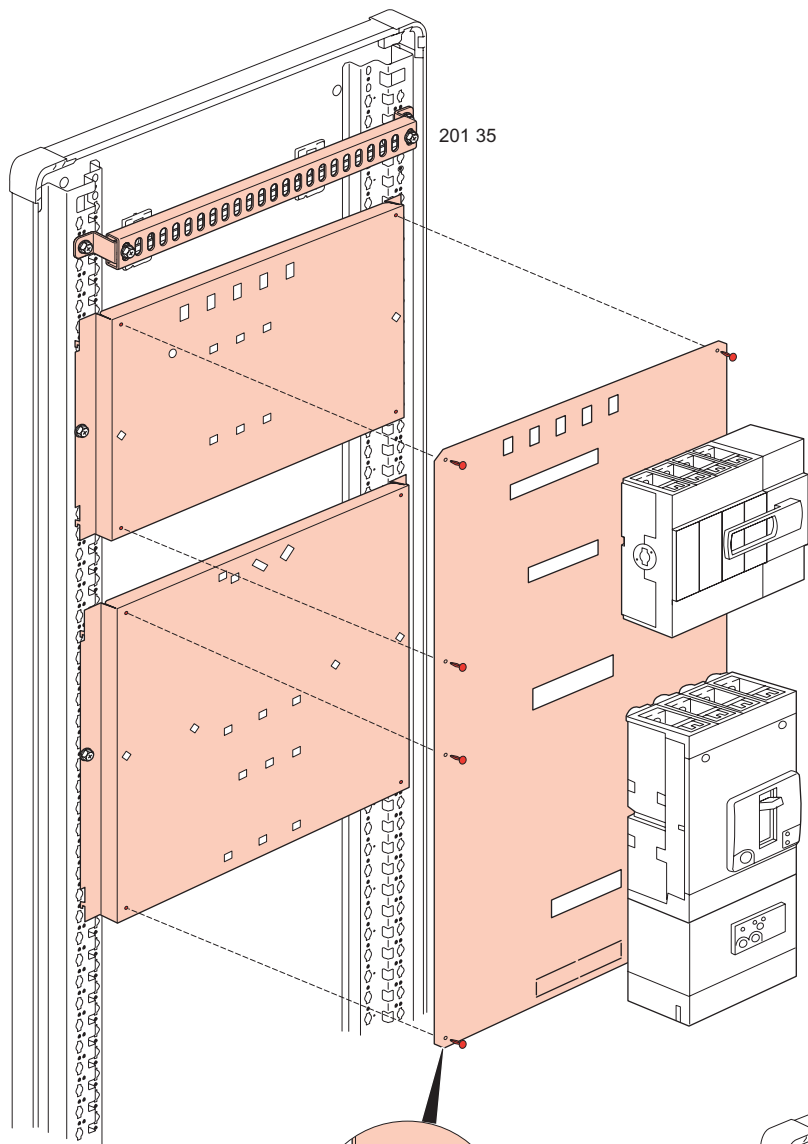





4P	
202 36/37 - 206 36/37	202 35
4 ■ 3 □ 4 □ 3 □ 3 □ 4 ■	1 □ 1 □ 2 ■ 2 □ 2 ■ 0 □
4 ■ 4 □ 4 ■	□ □ □
3 □ 3 □ 3 □	0 □
4 ■ 4 □ 4 ■	2 ■ 2 □ 2 ■ 1



202 32 - 206 32 DPX IS 250 + DPX 250ER
 202 33 DPX IS 630 + DPX 630
 206 33 DPX IS 630 + DPX 630



202 32 - 206 32	202 33 - 206 33
DPX IS 250	DPX IS 630
  	  
  	  
DPX 250ER 4P	DPX 630 4P
