

347 74

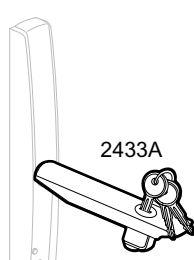

347 72

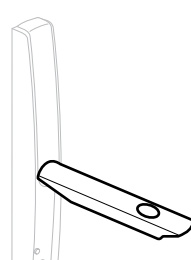

347 71

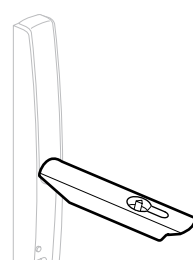

347 73

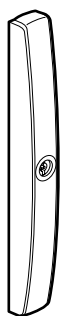

347 75

2433A

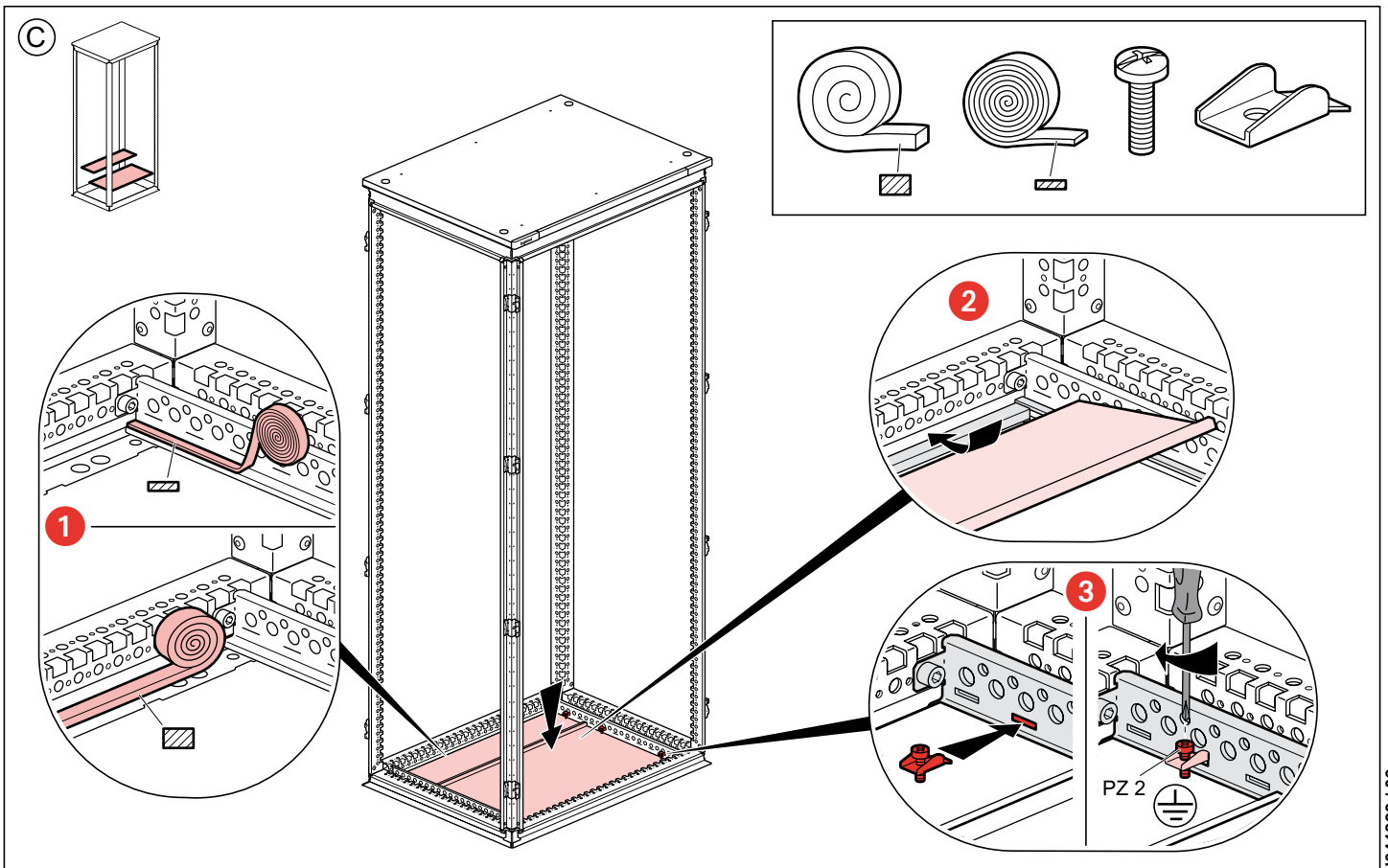
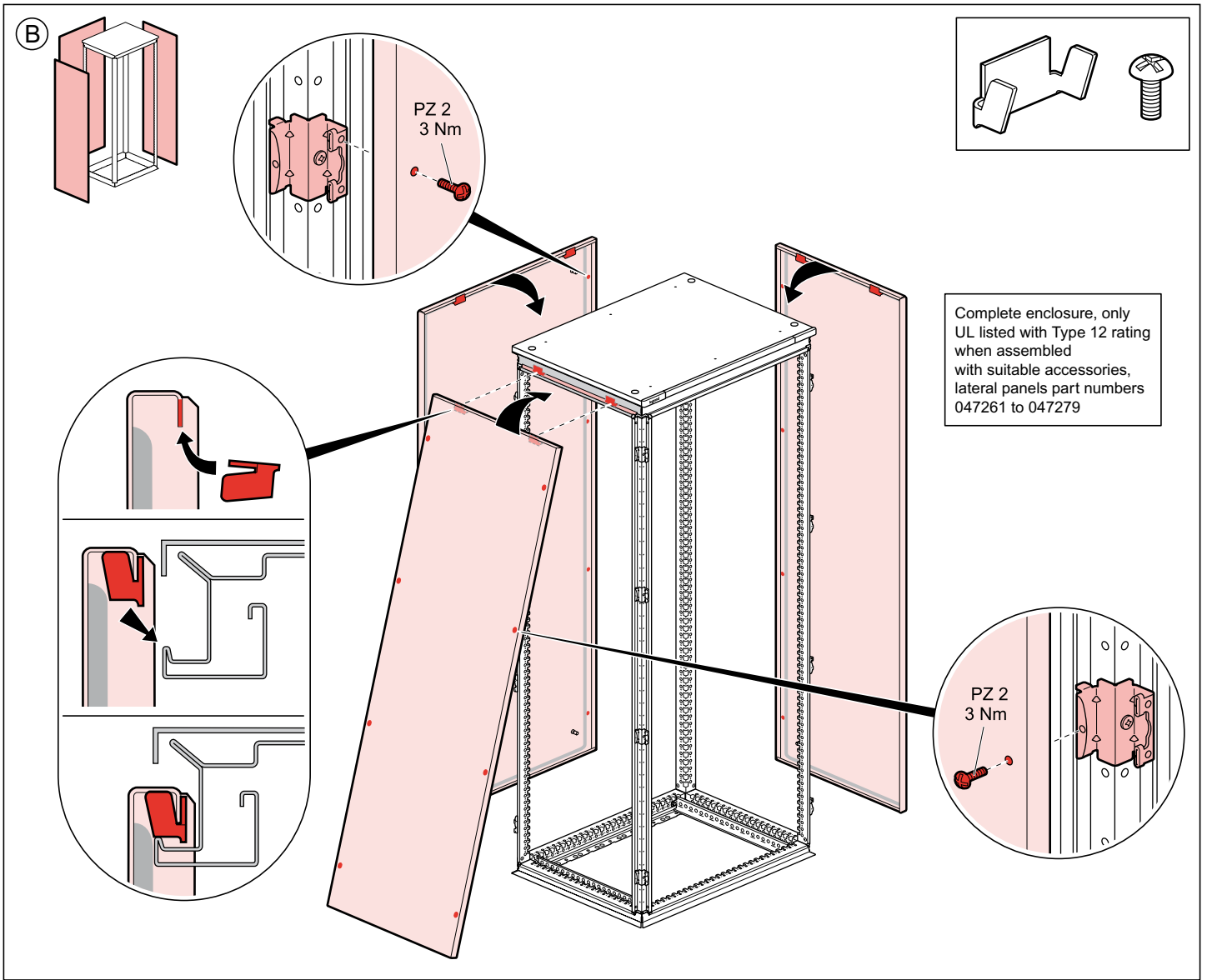

D

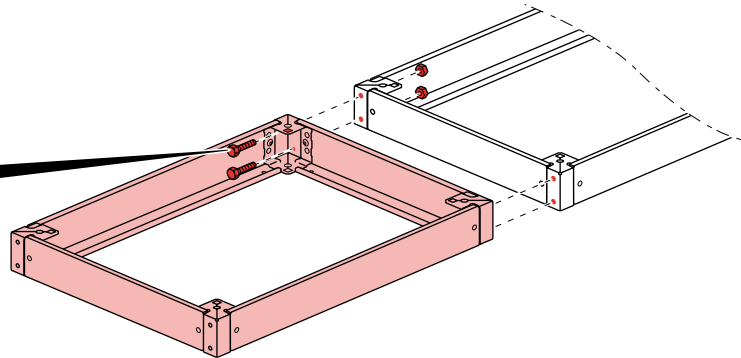
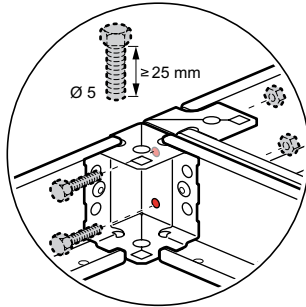
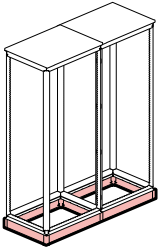
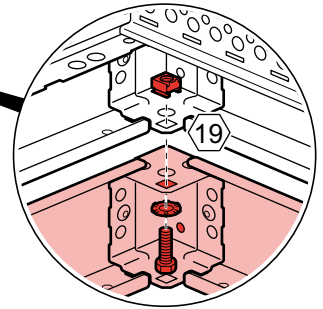
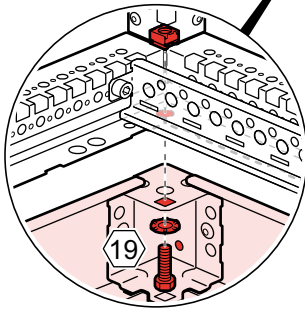
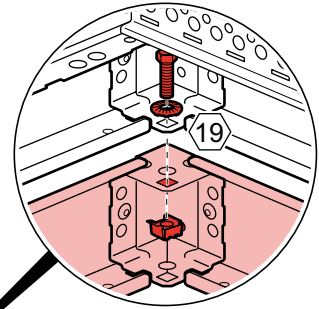
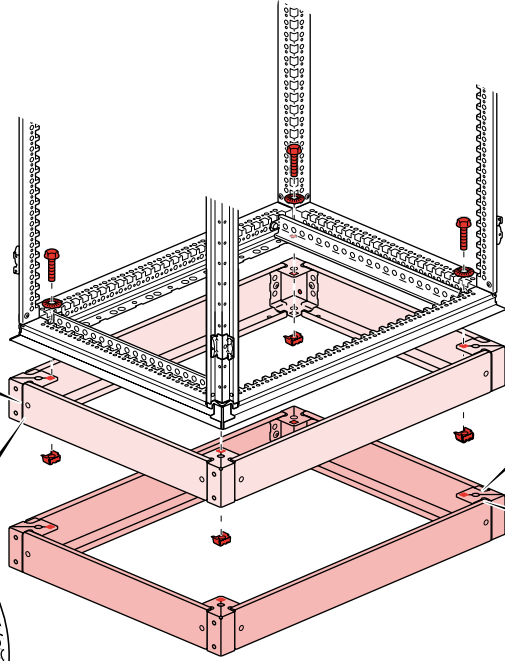
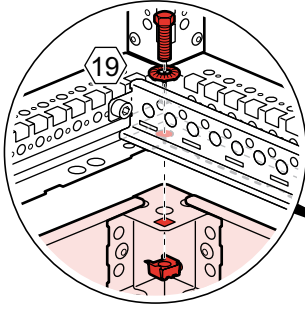
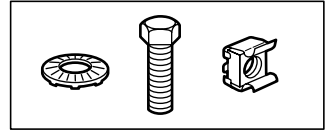
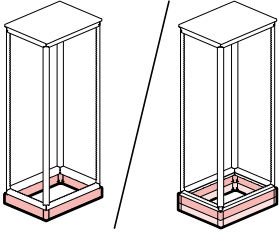

477 00

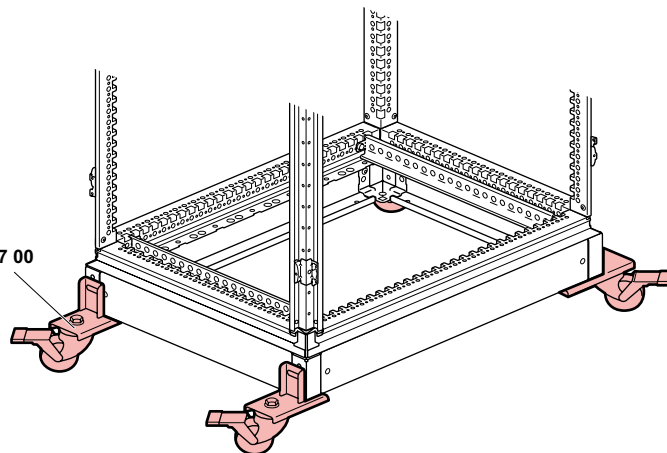

E₁

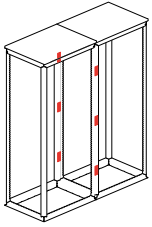

476 81

500 Kg/m³

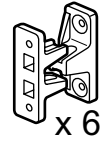

1

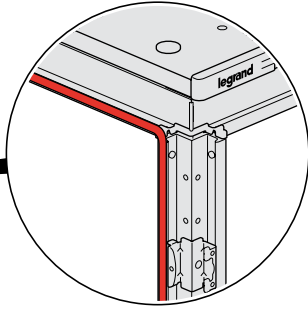
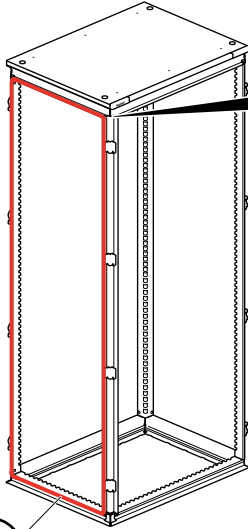

2

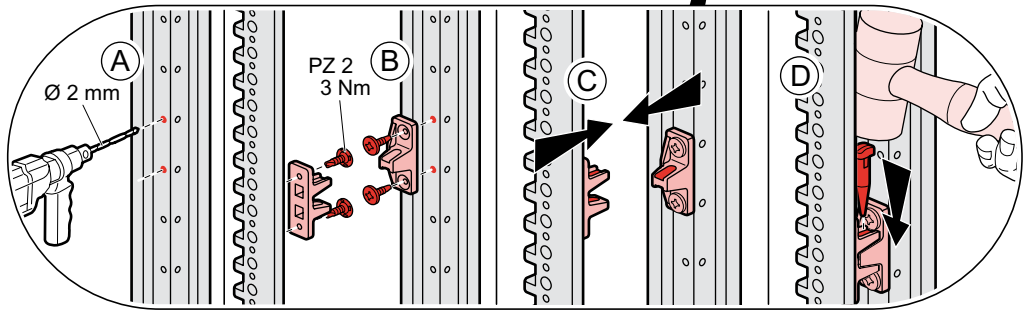
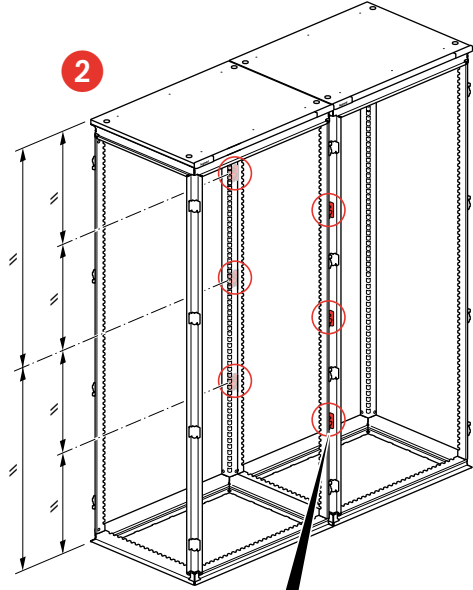

E₂

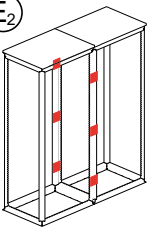

476 82

500 Kg/m³

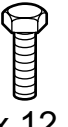
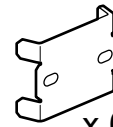

1

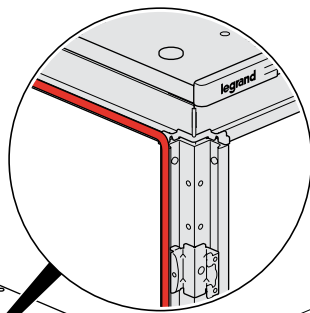
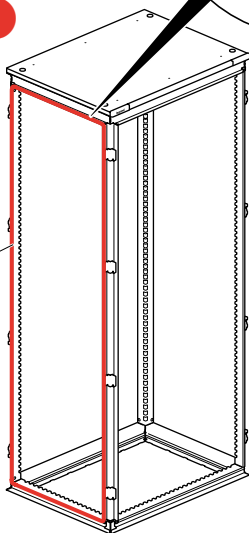

2

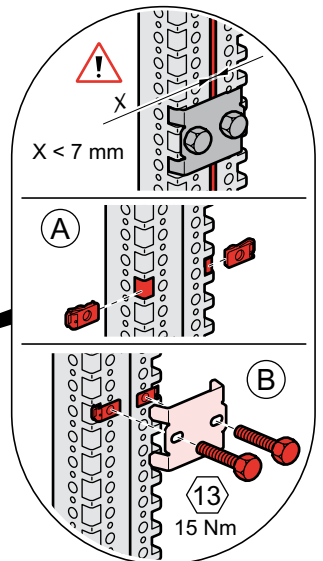
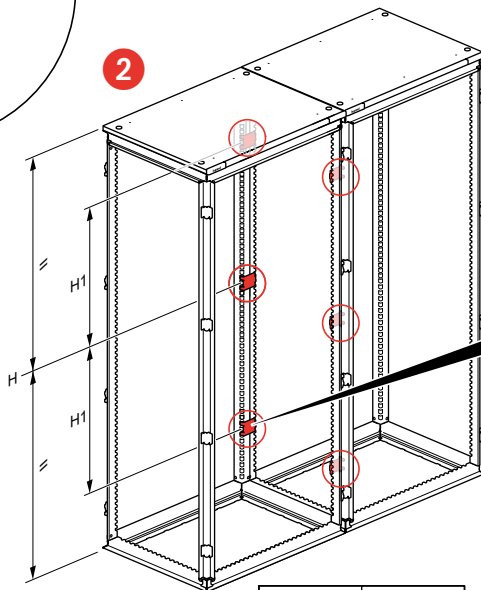

H(mm)	H1(mm)
1800	550
2000	650

E₃

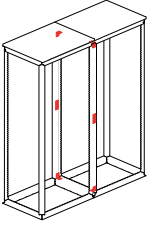

476 83

1000 Kg/m³

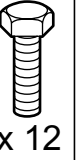
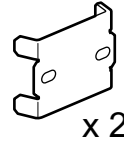
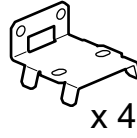

1

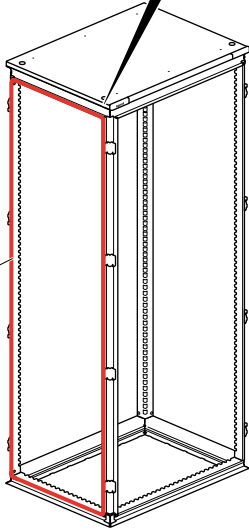
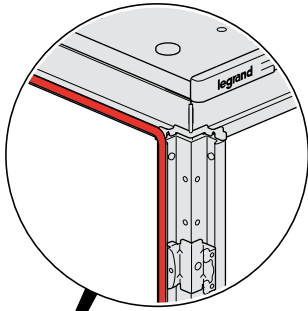

2

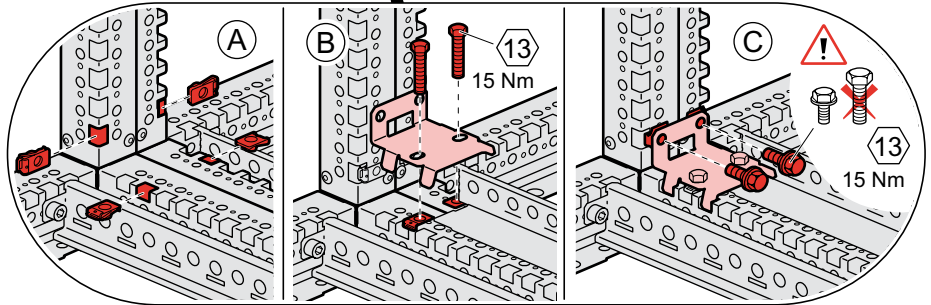
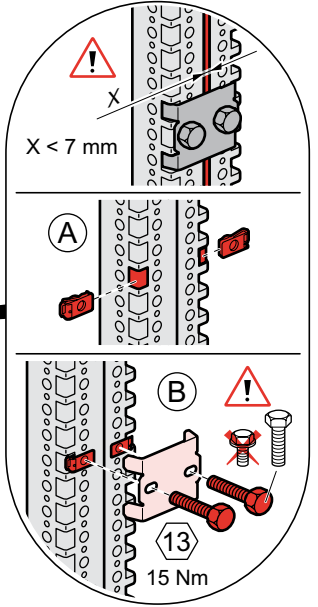
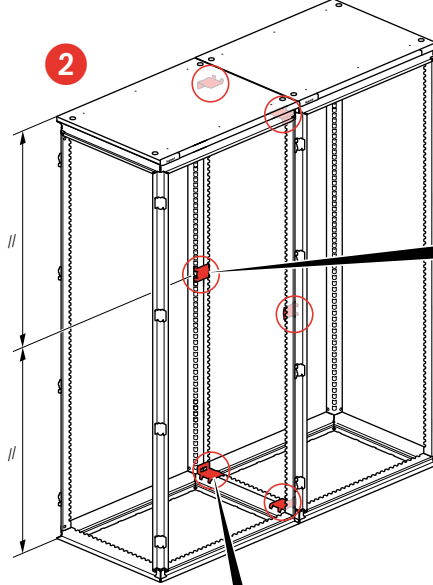

F

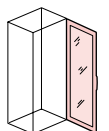
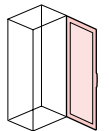
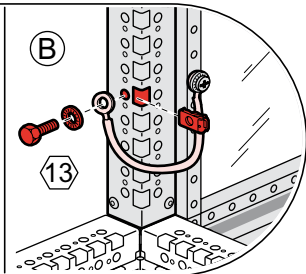
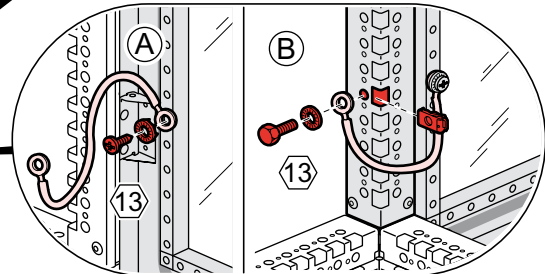
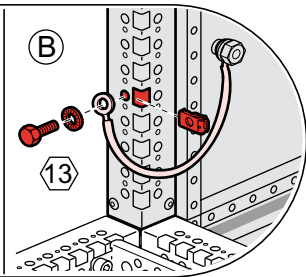
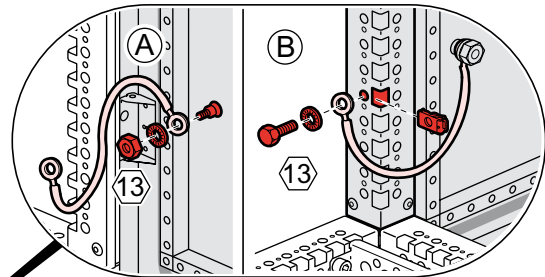
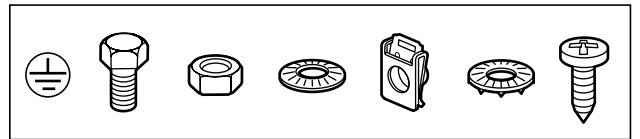
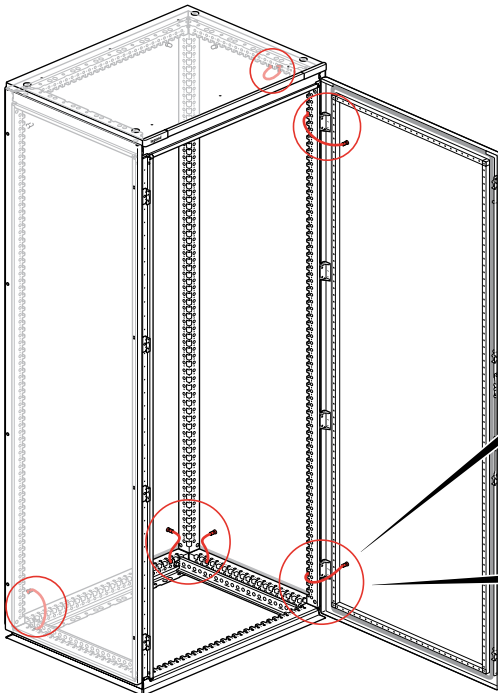
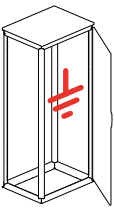

G₁

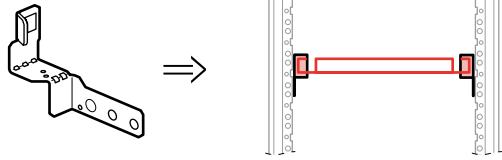

G₂

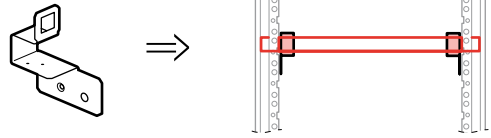

G₁

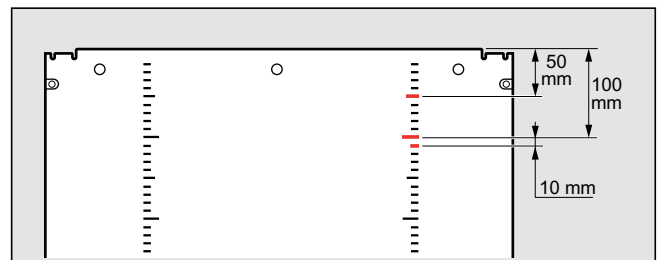
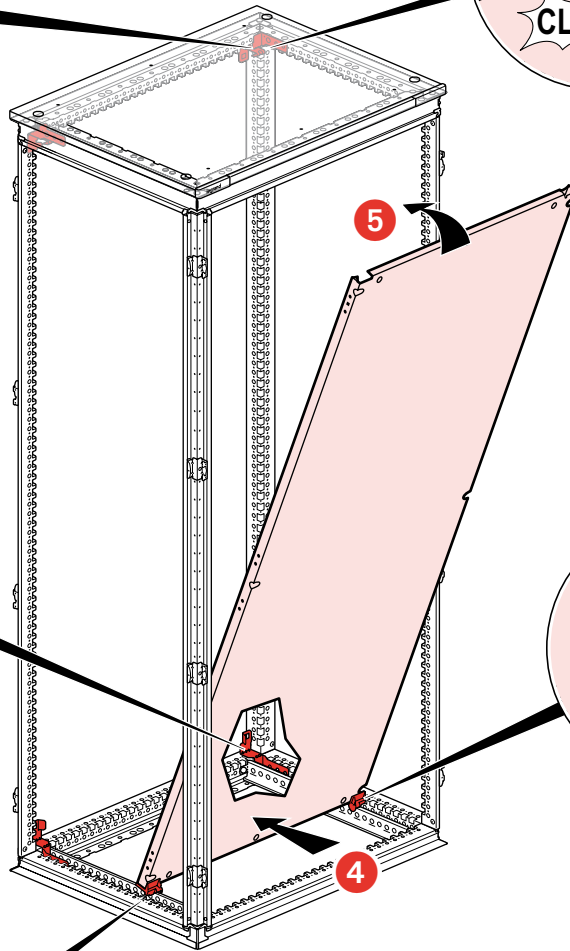
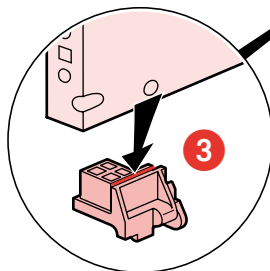
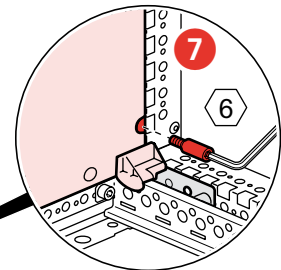
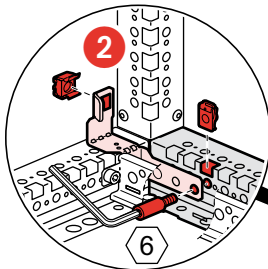
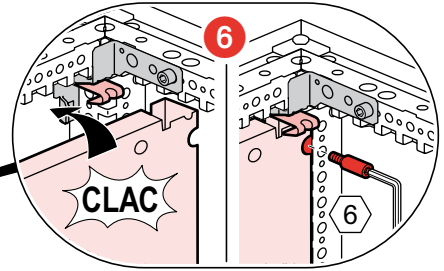
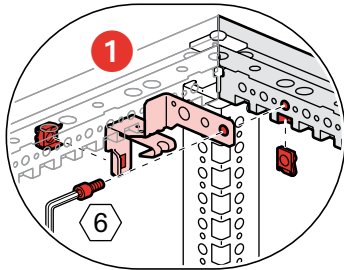
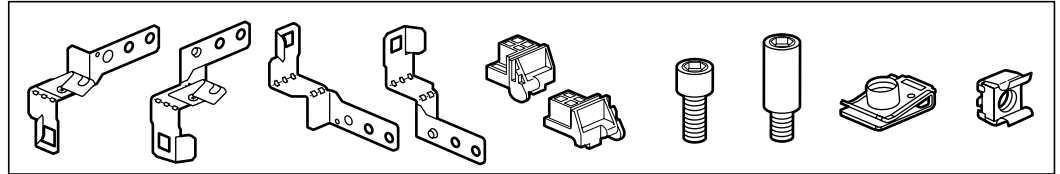
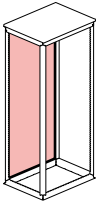

G₁

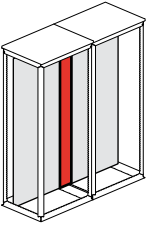

476 49 → 54

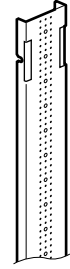

x 4



x 4

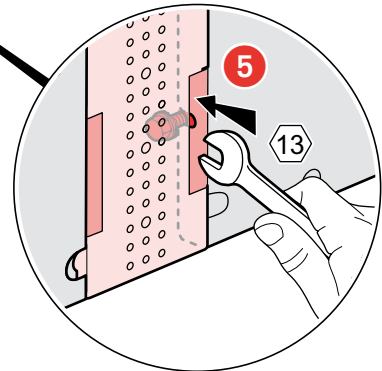
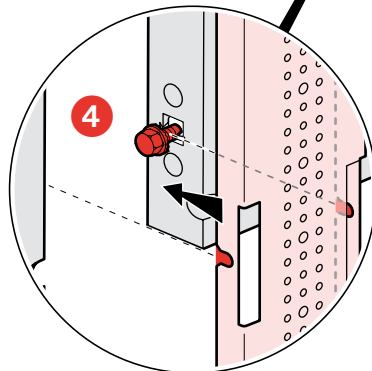
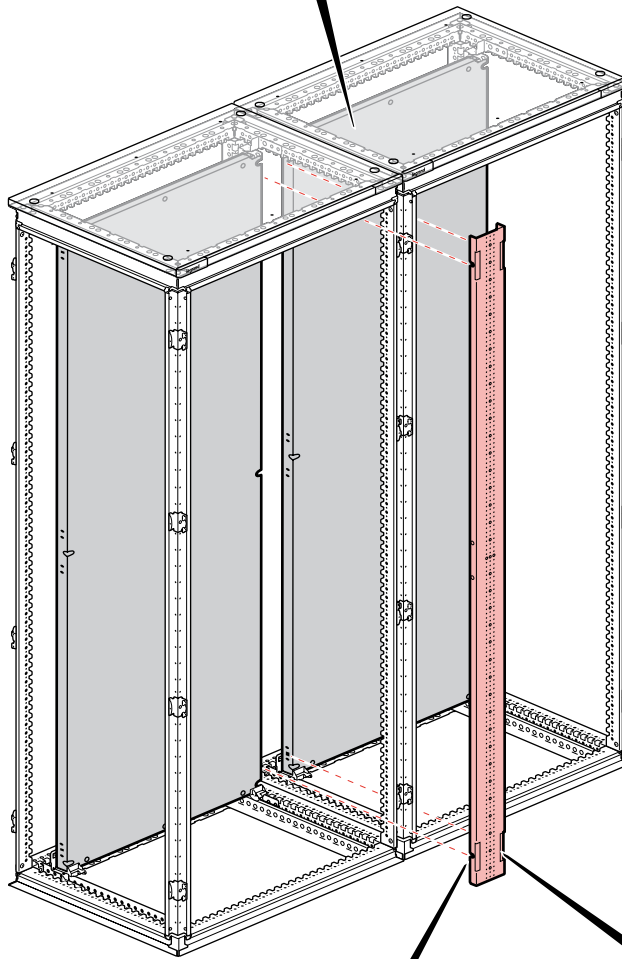
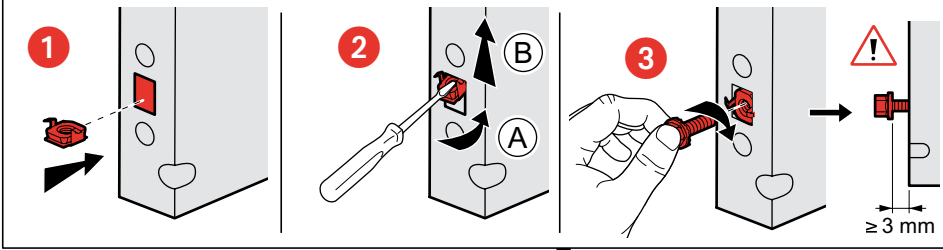

G₁

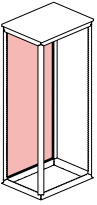

480 14 → 18

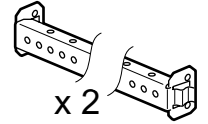

480 21

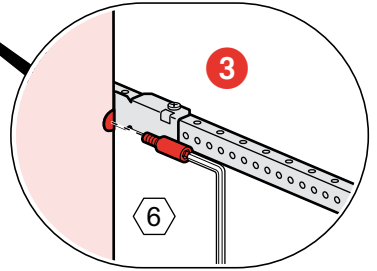
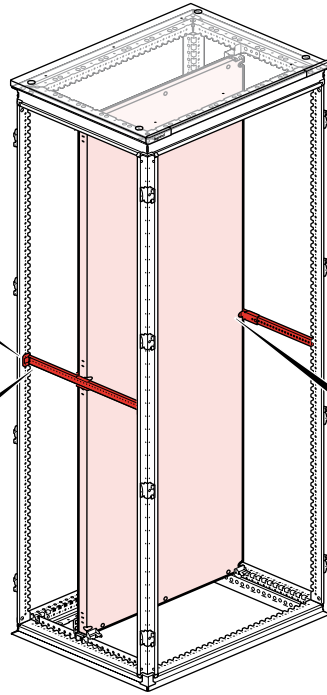
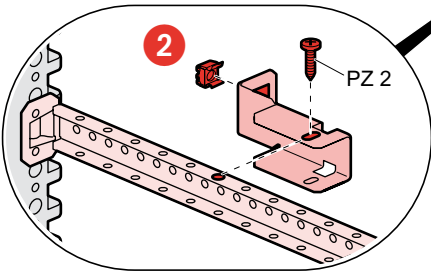
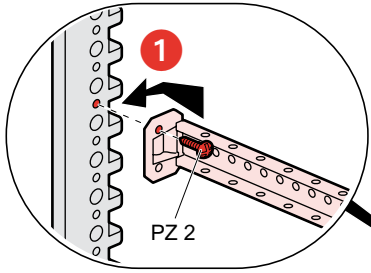
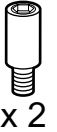
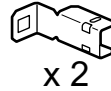

G₂

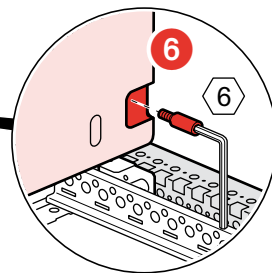
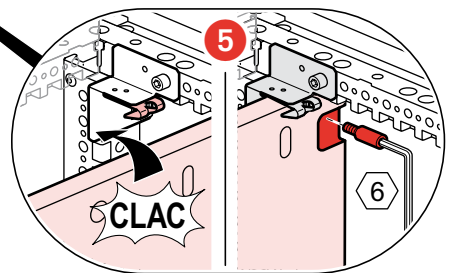
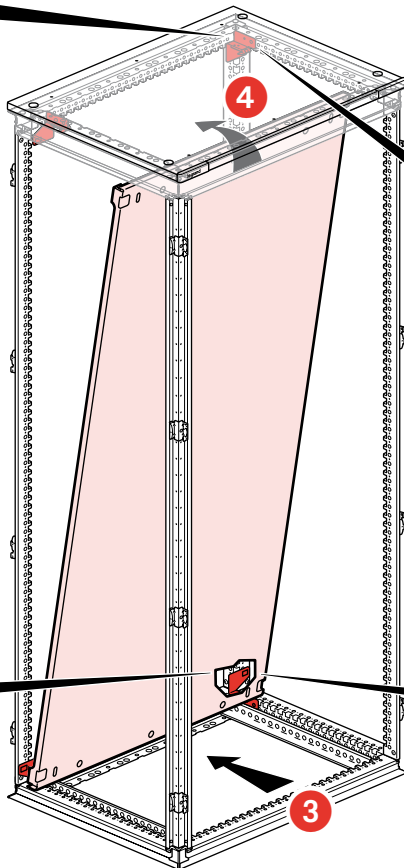
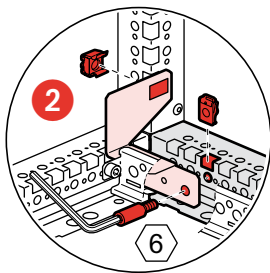
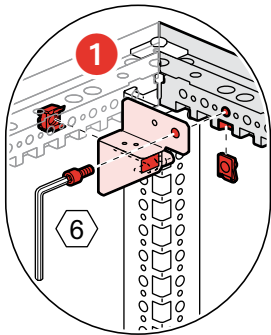
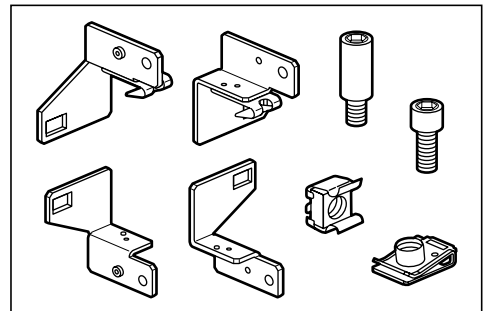
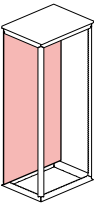

H

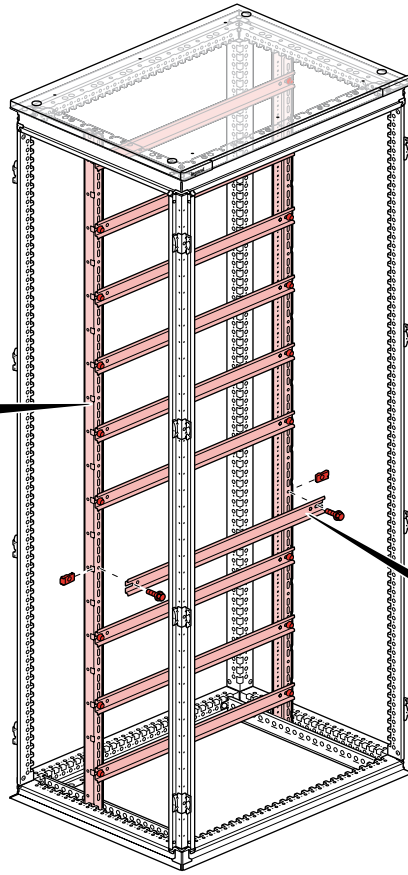
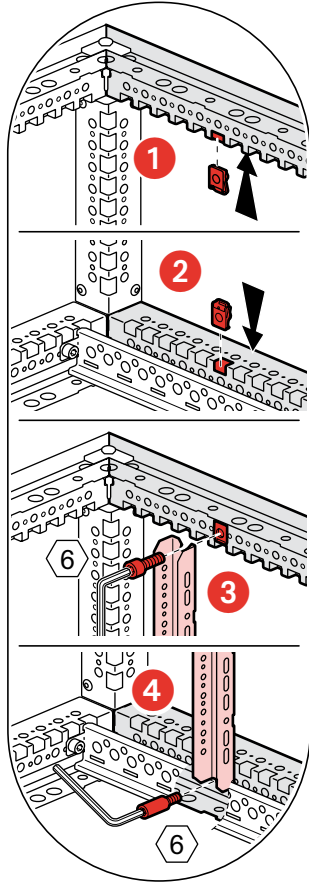
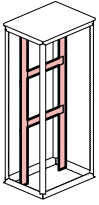

475 50 → 55

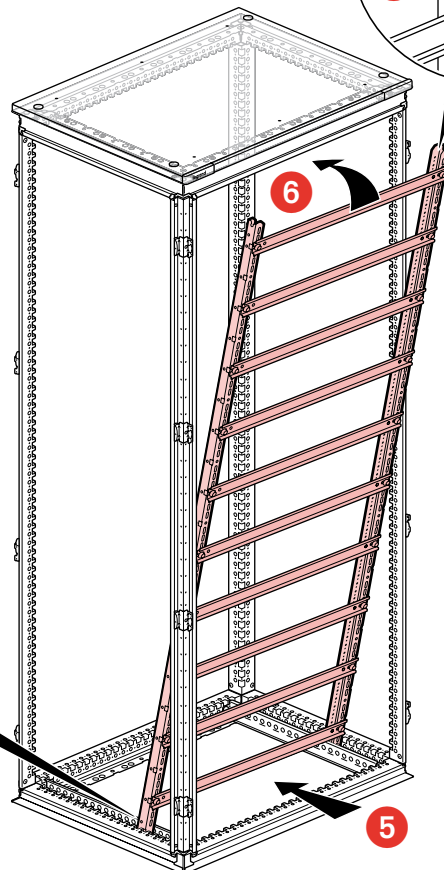
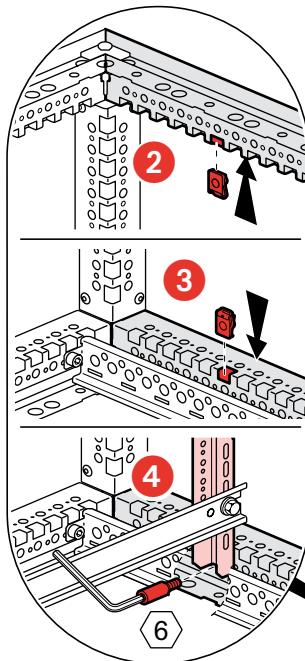
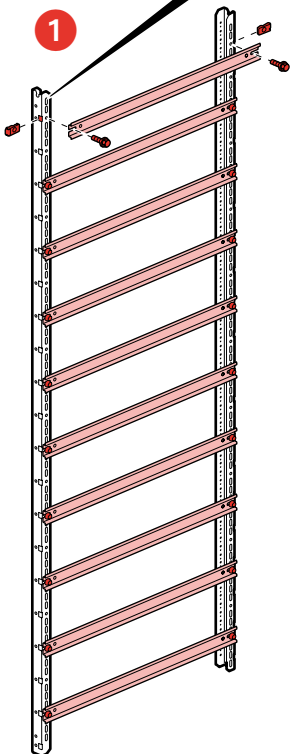
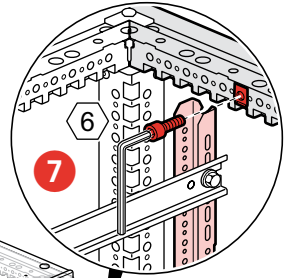
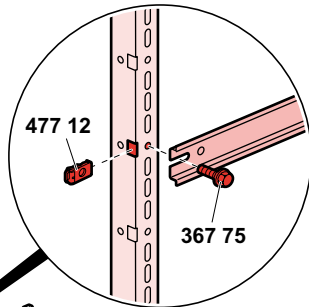
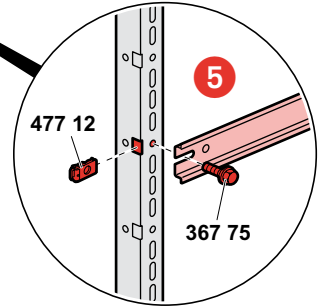
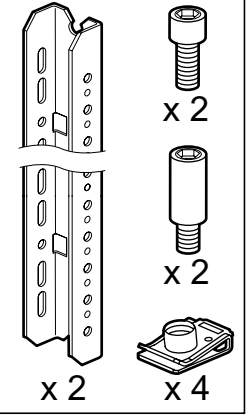

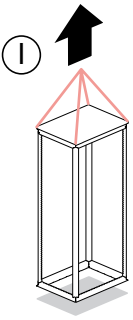

476 96

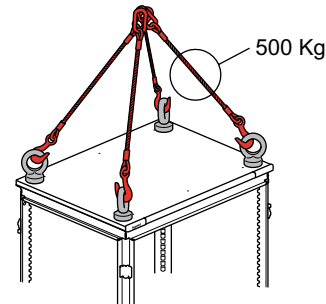
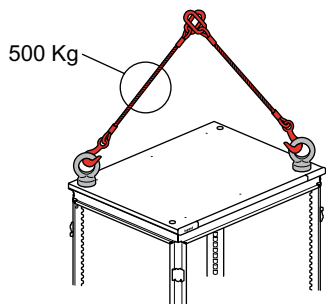
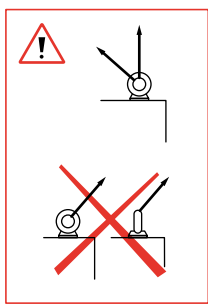
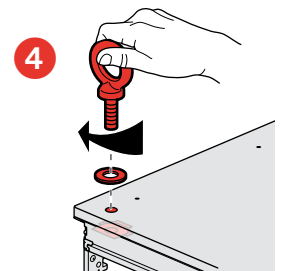
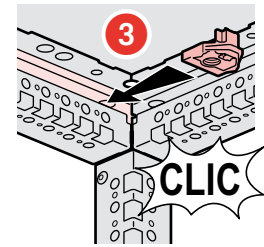
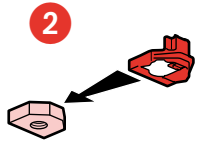
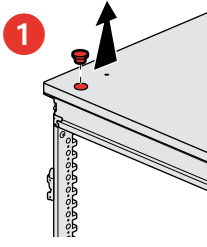
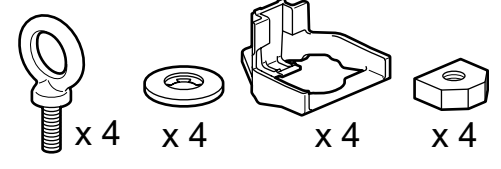

	P (Kg)	α (°)
	490	90
	610	60
	750	120
	1060	90
	1300	60

476 98

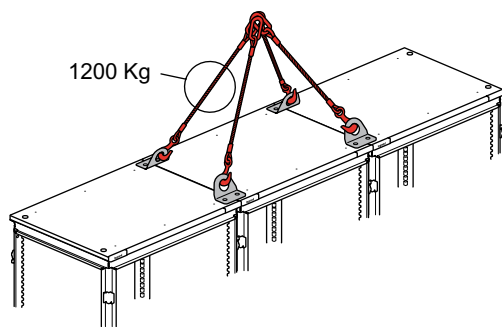
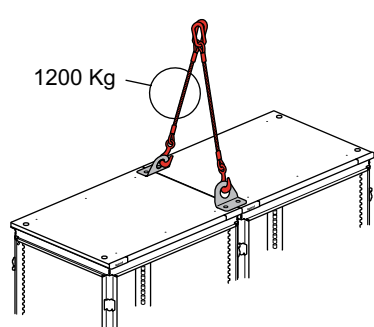
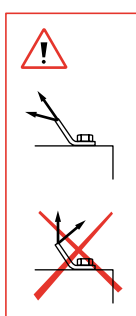
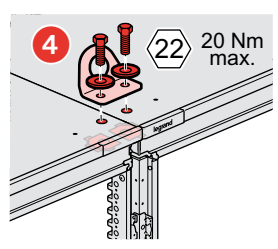
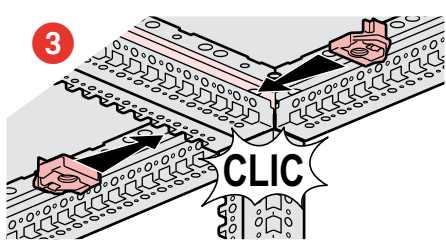
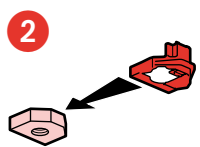
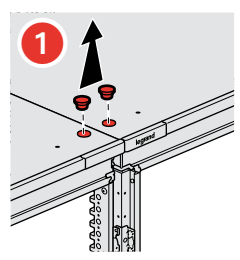
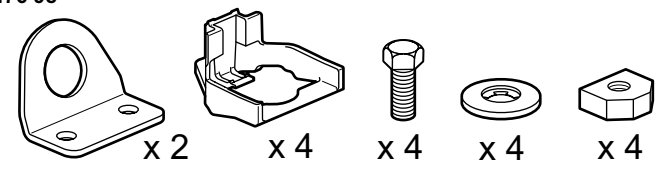

	P (Kg)	α (°)
	1700	90
	2000	60
	1800	120
	2500	90
	3200	60

J

