

Drawing Number – W22  
Outline Number – 100A297

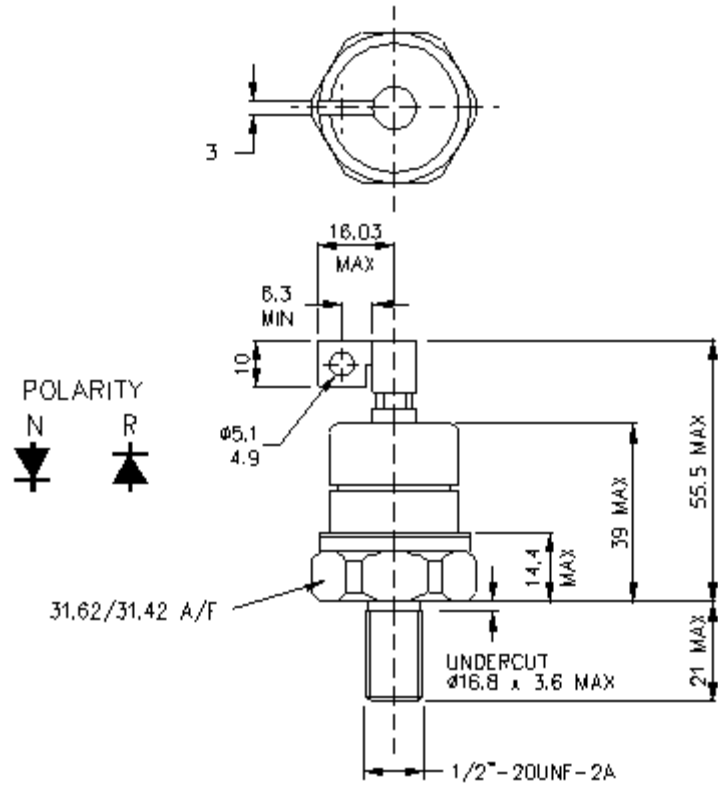

Weight 200g