



HV1000 PULSER OPERATION MANUAL

SERIAL NUMBER: _____

DATE: _____

Directed Energy, Inc.
2301 Research Blvd., Ste. 105
Fort Collins, Colorado 80526
970/493-1901 FAX 970/493-1903

TABLE OF CONTENTS

1.0 GENERAL DESCRIPTION.....	3
2.0 SPECIFICATIONS.....	4
2.1 Maximum Duty Cycles.....	5
2.2 Pulse Droop.....	5
3.0 SAFETY.....	6
3.1 Operating Safety Summary.....	6
3.2 Servicing Safety Summary.....	7
4.0 OPERATING CONSIDERATIONS.....	8
4.1 Output.....	8
4.2 Pulse Risetime and Faltime.....	8
4.3 Impedance Matching.....	8
4.4 Trigger Input.....	8
4.5 High Voltage Input.....	9
4.6 Maximum Duty Cycle.....	9
5.0 PREPARATION FOR USE.....	10
5.1 General.....	10
5.2 Initial Inspection.....	10
5.3 Electrical Installation.....	10
5.4 Mechanical Installation.....	10
5.5 Electrical Check.....	10
6.0 OPERATING INSTRUCTIONS.....	12
6.1 Power-Up Procedures.....	12
6.2 Power-Down Procedures.....	12
7.0 EXAMPLE WAVEFORMS.....	14
7.1 50 Ohm Resistive Load.....	14
7.2 Inductive Load (Step-Up Transformer).....	15
7.3 Capacitive Load.....	15
7.4 Current Source.....	16
8.0 TROUBLESHOOTING.....	17
8.1 Troubleshooting Procedures.....	17
8.2 Factory Service.....	18
9.0 SYSTEM FAILURE MODES.....	19
9.1 Over-Current Failure.....	19
9.2 Over-Voltage Failure.....	19
10.0 WARRANTY.....	20
11.0 APPENDIX A - Schematics.....	21

***** WARNING *****

SAFE OPERATING PROCEDURES AND PROPER USE OF THE EQUIPMENT ARE THE RESPONSIBILITY OF THE USER OF THIS SYSTEM.

Directed Energy, Inc (DEI) provides information on its products and associated hazards, but it assumes no responsibility for the after-sale operation and safety practices.

ALL PERSONNEL WHO WORK WITH OR ARE EXPOSED TO THIS EQUIPMENT MUST TAKE PRECAUTIONS TO PROTECT THEMSELVES AGAINST POSSIBLE SERIOUS AND/OR FATAL BODILY INJURY. DO NOT PERFORM INTERNAL REPAIR OR ADJUSTMENTS UNLESS ANOTHER PERSON CAPABLE OF RENDERING FIRST AID AND RESUSCITATION IS PRESENT.

1.0 GENERAL DESCRIPTION

The HV1000 Pulser is a high voltage pulse generator designed to be operated into a load impedance of 50 ohms. The HV1000 is designed as an instrument for lab experiments, calibration, component testing, beam steering, gating PMTs and MCPs, and other applications that require very fast and clean high speed pulses, or incorporated into an OEM system.

The HV1000 utilizes a patented state-of-the-art high-speed power MOSFET as the high voltage switch, incorporated into a low impedance configuration featuring a multi-layer stripline-style output bus.

The HV1000 requires an external high voltage DC supply (950V maximum), and an input trigger. The unit is available in either positive or negative polarities. The polarity of the DC power supply must be the same as the polarity of the HV1000 (i.e. a positive-polarity HV1000 requires a positive polarity DC power supply; a negative-polarity HV1000 requires a negative polarity DC power supply).

2.0 SPECIFICATIONS

(All Measurements into 50 Ohms)

INPUT HIGH VOLTAGE

Maximum Value.....950 volts DC
 Minimum Value.....0 volts DC
 Input High Voltage Connector.....Type N,
 Side Panel

OUTPUT HIGH VOLTAGE

Maximum Value.....850 volts DC
 Minimum Value.....0 volts DC
 Maximum Current.....17 amperes
 Means of adjustment.....Controlled by Input High Voltage
 Output High Voltage Connector.....Type BNC,
 Side Panel

TRIGGER

Trigger Source.....External
 Trigger Input.....+5V +/-1V,
 Into 50 ohms
 Trigger Rise Time.....<6ns
 Minimum Trigger Pulse Width.....55ns
 Maximum Trigger Pulse Width.....10us
 Input Trigger Connector.....Type BNC,
 Side Panel

OUTPUT PULSE ELECTRICAL CHARACTERISTICS

Pulse Rise Time (Negative Polarity).....6ns 850V
 (10%-90%)
 Pulse Rise Time (Positive Polarity).....10ns 850V
 (10%-90%)
 Pulse Width.....55ns to 10us,
 Controlled by Input Trigger
 Pulse Recurrence Frequency.....Single Shot to 1MHz, 5MHz
 burst, controlled by input
 trigger
 Over/undershoot.....<5%
 Jitter.....<100ps shot-to-shot
 Delay Between Trigger and Output Pulse.....<40ns
 Thermal Drift.....Approx 500ps to 1ns over
 ambient to 50°C

GENERAL

Input AC Power.....110/220 VAC, 50/60Hz, Cord
 provided
 Dimensions.....8.32" L x 4.22" W x 1.72" D
 Weight.....Approx. 3.5 lbs.

2.1 Maximum Duty Cycles

All measurements into 50 ohms.

V_{IN}	I_{OUT}	P_{PEAK}	DUTY CYCLE (MAX)
950V	17.0A	14.50KW	1%
525V	9.5A	4.50KW	4%
105V	2.0A	0.20KW	10%

2.2 Pulse Droop

All measurements into 50 ohms.

V_{IN}	PULSE WIDTH	PERCENTAGE DROOP
950V	1.0us	3.0%
950V	10.0us	24.0%
525V	1.0us	1.5%
525V	10.0us	16.0%
105V	1.0us	<0.5%
105V	10.0us	7.0%

3.0 SAFETY

The high voltage nature of this device dictates the use of caution when operating or servicing this equipment. The following is a summary of general safety precautions that must be observed during all phases of operation and repair of the HV1000 Pulser.

3.1 Operating Safety Summary

The safety information contained in this summary is for both operating and servicing personnel. Specific warnings may be found throughout this manual, but may not appear in this summary.

3.1.1 Power Source

The HV1000 is designed to operate from a power source that will not apply more than 220 volts between the supply conductors or between either supply conductor and ground. A protective grounding connection by way of the grounding conductor in the AC power cord is essential.

3.1.2 Grounding

The HV1000 is grounded through the grounding conductor of the AC power cord. **To avoid electrical shock, plug the HV1000 into a properly wired receptacle before making connection to any input or output connectors.** Use only a power cord that is in good condition.

3.1.3 Cover Removal

To avoid personal injury, do not remove the cover. **Do not operate the HV1000 while the cover is removed.** The cover does not contain a safety interlock!

3.1.4 General Operating Precautions

Do not remove the input or output cables while the pulser is in operation. Never short-circuit the high voltage output of the pulse generator. Failure to observe these precautions can result in potential electric shock to personnel, arcing, and damage to the connectors and system.

The top cover of the pulse generator is not safety interlocked. Extreme caution should be exercised when removing the cover.

Any pulsed power system is capable of random triggering via transients. Therefore when the pulse generator is turned on, or high voltage is present in the chassis, assume it is possible to get a pulse on the output connector.

3.2 Servicing Safety Summary

The HV1000 contains dangerous voltages and stored energy. DEI strongly recommends that all repairs and adjustments be performed by factory qualified personnel. DEI will not be responsible for personal injury or damage to the pulser that occurs during repair by any party other than the factory.

3.2.1 Servicing Procedure

Do not perform internal repair or adjustments unless another person capable of rendering first aid and resuscitation is present.

3.2.2 Internal Energy Storage

The HV1000 contains capacitors that are used as energy storage elements. When charged, these capacitors contain in excess of 1.5 joules of stored energy. This is sufficient energy to cause serious injury. **Assure that the AC power cord is disconnected from the pulser, and that the capacitor bank is fully discharged and a shorting strap installed before any repairs or adjustments are attempted.** Verify with a voltmeter that all circuits are de-energized before servicing. The voltmeter used to make these measurements must be certified for use at 1000VDC and 220VAC or greater. Dangerous voltages, floating ground planes and energy storage exist at several locations in the HV1000. Touching connections and/or components could result in serious injury.

4.0 OPERATING CONSIDERATIONS

4.1 Output

The HV1000 is designed to operate into a load whose characteristic impedance is 50 ohms. An unterminated or improperly terminated output will cause excessive aberrations on the output waveform and could possibly damage the pulser. To ensure this does not occur, observe the following precautions:

- Use good quality 50 ohm coaxial cable and connectors;
- Make all external connections tight and as short as possible;
- Use good quality attenuators and/or loads. If using an attenuator, DEI recommends the Weinschel Engineering model 45-40-33. Small attenuators will not work correctly and can be harmed by the HV1000;
- Use terminators or impedance-matching devices to avoid reflections;
- Ensure that all external cables and hardware have adequate voltage and power ratings;
- Be extremely careful not to short the output of the pulser to ground, as this can cause damage to the pulser.

The HV1000 can be used to drive capacitive, inductive and resistive loads other than 50 ohms. Please consult the factory for further applications information.

4.2 Pulse Risetime and Faltime

The physical and electrical characteristics of the cable transmitting the pulse determine the characteristic impedance, velocity of propagation and the amount of signal loss. Several feet of cable can attenuate high frequency information in a pulse with a fast rise time. It is therefore important to keep these cables as short as is practical. For optimum performance, DEI recommends interconnecting cable lengths of 8" or less. When signal comparison measurements or time difference determinations are made, the two signals from the test device should travel through coaxial cables with identical loss and time delay characteristics.

4.3 Impedance Matching

If a pulse travels down a transmission line and encounters a mismatch, a reflection is generated and sent back along the line to the source. The amplitude and polarity of the reflection are determined by the impedance mismatch. If the reflected signal returns before the output pulse ends, it adds or subtracts from the amplitude of the pulse. This will distort the pulse shape and amplitude.

4.4 Trigger Input

An input trigger of +5V +/-1V into 50 ohms with a risetime

of <6ns is required to gate on the HV1000. Departure from these values can result in a loss of performance. These trigger requirements are met by any high quality low voltage pulse generator. The trigger should be set to +5V +/-1V into 50 ohms before the trigger cable is attached to the HV1000 trigger input. The input trigger is transformer-coupled into a DS0026 CMOS Clock Driver which does not appear resistive to the input pulse generator. For this reason, the input trigger amplitude should be set using a 50 ohm load (e.g. a 50 ohm scope input) before connecting it to the HV1000. If the trigger input is greater than +5V into 50 ohms, pulse stretching can occur.

4.5 High Voltage Input

The HV1000 is rated at a maximum input voltage of 950VDC. Proper precautions should be taken by the user to ensure that the maximum voltage is not exceeded. The polarity of the DC power supply must be the same as the polarity of the HV1000 (i.e. a positive-polarity HV1000 requires a positive polarity DC power supply; a negative-polarity HV1000 requires a negative polarity DC power supply).

4.6 Maximum Duty Cycle

The case of the HV1000 (specifically the bottom panel) is used as the heat sink for the power circuitry. Therefore the case can get hot! Use caution when handling the HV1000 after operation. The duty cycle percentages shown in TABLE 2.1 are limited by the cooling capabilities of the HV1000. Higher duty cycles can be obtained by forced air cooling of the enclosure, or for very high power applications (>1Kw), bolting the HV1000 to a water or air cooled heat sink.

5.0 PREPARATION FOR USE

5.1 General

After unpacking, initial inspection and preliminary electrical check procedures should be performed to assure that the unit is in good working order. If it is determined that the unit is damaged, the carrier should be notified immediately. Repair problems should be directed to the service department, Directed Energy, Inc. (DEI), Fort Collins, Colorado. Telephone: (303) 493-1901.

5.2 Initial Inspection

1. Inspect unit for exterior mechanical damage.
2. Inspect power input cord and input power module for obvious signs of damage.
3. Remove top cover retaining screws. Inspect components and printed circuit board for damage.

5.3 Electrical Installation

Standard units are shipped ready for use with a nominal 110 VAC input. The unit can be configured for 220VAC input from the factory.

5.3.1 Input Power Cord

The input power cord terminates externally in a three-prong polarized plug. The unit chassis is wired to the plug through the line cord, and therefore, the insertion of the plug into a compatible receptacle, hooked up to a grounded input, will automatically ground the unit. **The unit should not be operated without a grounded AC input!**

5.4 Mechanical Installation

As received, the unit is ready for bench use. If necessary, the unit can be bolted to an external heat sink for additional cooling (see Section 4.6 above) using the mounting flanges.

The HV1000 is extremely rugged, and can be mounted to other equipment, hardware or benches using the mounting flanges. Physical orientation is not critical.

5.5 Electrical Check

Before proceeding, please review the precautions in Section 3.

5.5.1 Power-Up

The unit should be powered up using the following procedures:

1. Ensure that the high voltage power supply is turned off, and all controls set to zero volts.

2. Before connecting the pulse generator to the HV1000, set up the pulse generator output to deliver a 5V pulse (+/-1V) into 50 ohms, with a rep rate of approximately 5KHz, and a pulse width of 200-500ns.
3. Plug the power cord into the AC power input. The red indicator light should turn on, indicating that the HV1000 is operational. If this does not occur, unplug the unit from the AC power, and refer to the Troubleshooting Section of this manual.
4. Connect the cable from the high voltage power supply to the N connector of the HV1000 labeled "HV IN, 950V MAX".
5. Connect the pulse generator to the BNC connector of the HV1000 labeled "TRIGGER INPUT".
6. Connect an appropriate load to the BNC connector of the HV1000 labeled "OUTPUT".
7. Monitor the voltage across the load, utilizing an appropriate attenuator.
8. Turn ON the high voltage power supply. Slowly increase the power supply to 100VDC. The HV1000 should produce an output pulse of approximately 95V, with a pulse width and pulse recurrence frequency following that of the incoming trigger.
9. If there is no output from the HV1000, or the output is severely distorted, set the output voltage of the high voltage power supply to zero and turn off the high voltage power supply. Leave the HV1000 connected to the AC input without high voltage and with all connectors in place for approximately one minute to bleed off the stored energy, then disconnect the AC power to the unit and refer to the Troubleshooting Section of this manual.

6.0 OPERATING INSTRUCTIONS

This section provides basic operating instructions for the HV1000. Additional application information may be found in Section 7.0.

WARNING

1. To avoid personal injury, do not remove the cover. **Do not operate the HV1000 while the cover is removed.** The cover does not contain a safety interlock!
2. Do not remove the input or output cables while the pulser is in operation. Never short-circuit the high voltage output of the pulse generator. Failure to observe these precautions can result in potential electric shock to personnel, arcing, and damage to the connectors and system.
3. The top cover of the pulse generator is not safety interlocked. Extreme caution should be exercised when removing the cover.
4. Pulsed power systems are capable of random triggering via transients and therefore when the pulse generator is turned on, or high voltage is present in the chassis, assume it is possible to get a pulse on the output connector.

6.1 Power-Up Procedures

The unit should be powered up using the procedures detailed in Section 5.5.1. When this is accomplished, the pulser can be adjusted for the particular application through the following procedure:

1. Monitoring the output of the HV1000 on an oscilloscope utilizing an appropriate attenuator, set the output amplitude of the HV1000 to the desired level by adjusting the high voltage power supply.
2. Set the output pulse width and pulse recurrence frequency by varying the controls of the input pulse generator. The output pulse width should be set by monitoring the output of the HV1000. The output high voltage will follow the input trigger, but will not replicate in time the exact duration of the input trigger due to the system propagation delay.

6.2 Power-Down Procedures

1. Set the output voltage of the high voltage power supply to zero and turn off the high voltage power supply.

- 2 Leave the HV1000 connected to the AC input without high voltage and with all connectors in place for approximately one minute to bleed off the stored energy.
3. Disconnect the AC power to the unit.

7.0 EXAMPLE WAVEFORMS

7.1 50 Ohm Resistive Load

Input Voltage=105V, Pulse Width=500ns, Pulse Recurrence Frequency=1MHz, Load=50 ohms:

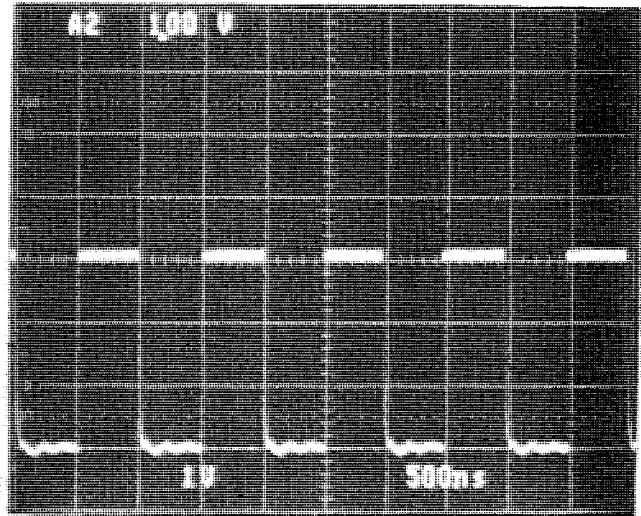
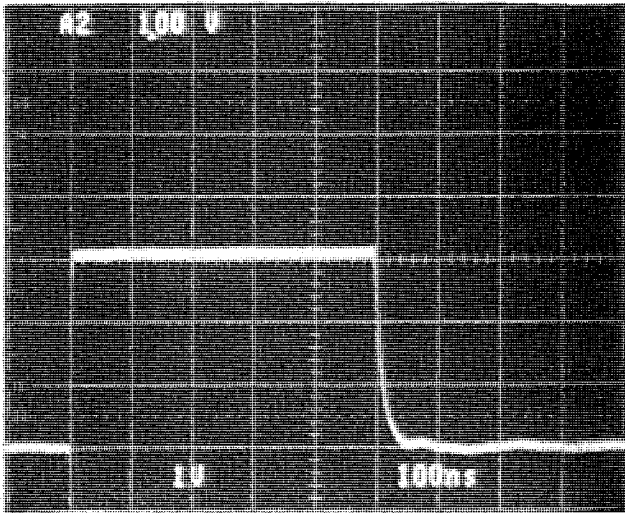

Input Voltage=950V, Pulse Width=100ns, Pulse Recurrence Frequency=4.5MHz (Burst Mode), Load=50 ohms:

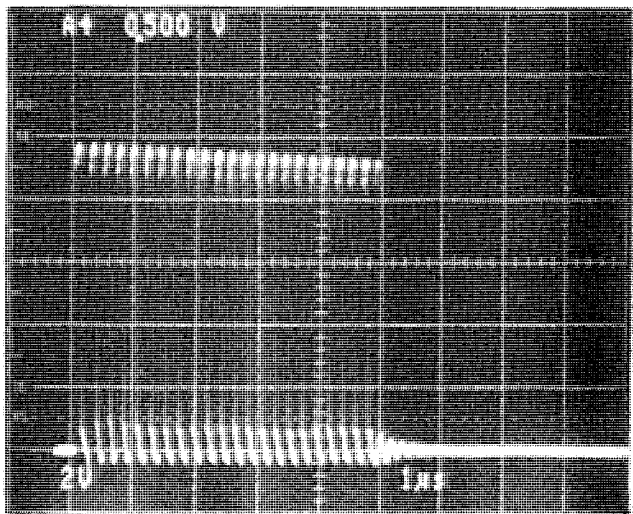
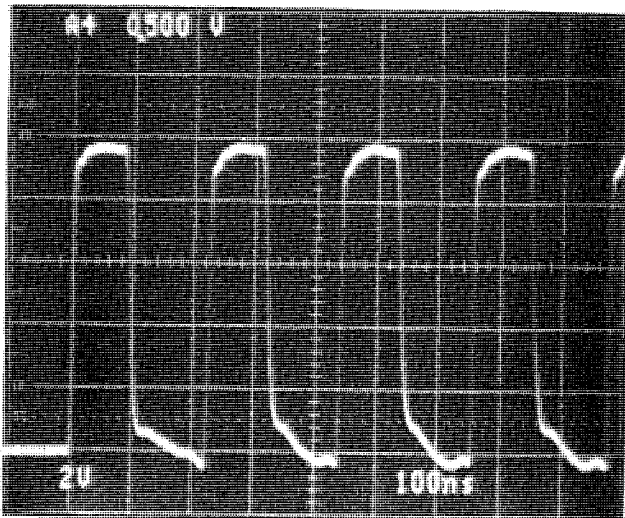

7.2 Inductive Load (Step-Up Transformer)

Input Voltage=950V, Pulse Width=200ns, Pulse Recurrence Frequency=500Hz, Oscilloscope Scale=1000V/DIV, Load=1000 ohm in secondary:

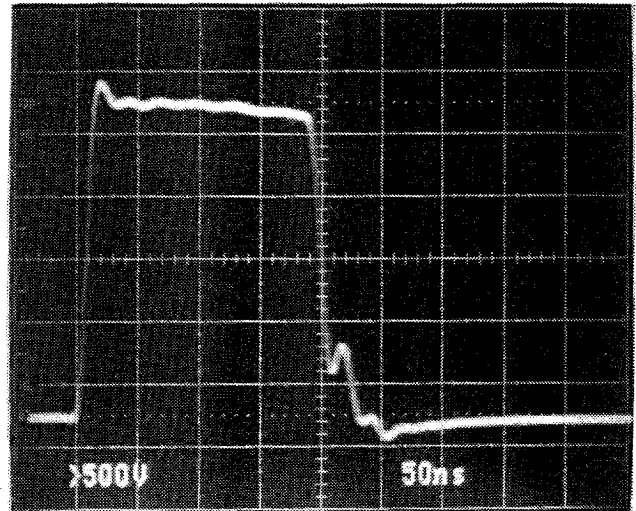
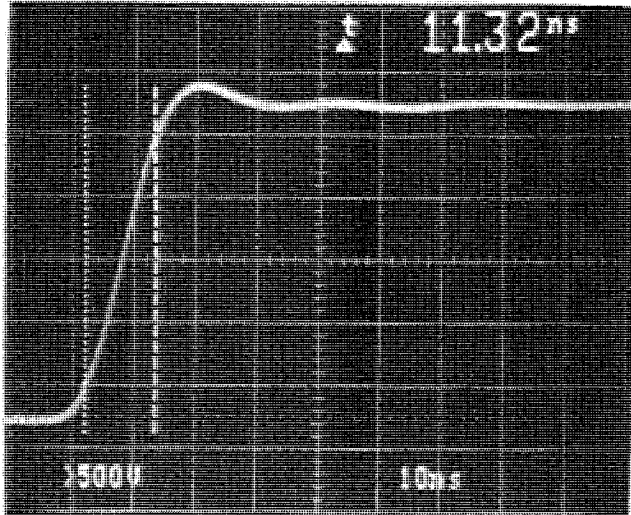

7.3 Capacitive Load

Input Voltage=150V, Oscilloscope Scale=5A/DIV, Load=0.1mF, 1KV Ceramic Capacitor, Traces show Voltage and Current:

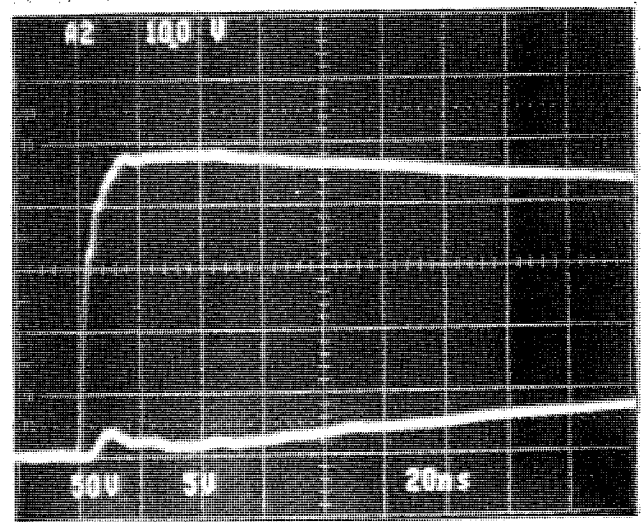
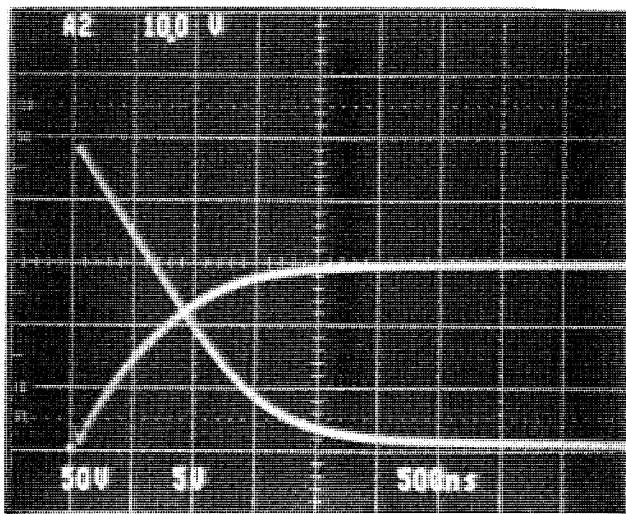

7.4 Current Source

Input Voltage=575V, Pulse Width=400ns, Oscilloscope
Scale=10A/DIV, Load=5 ohms:

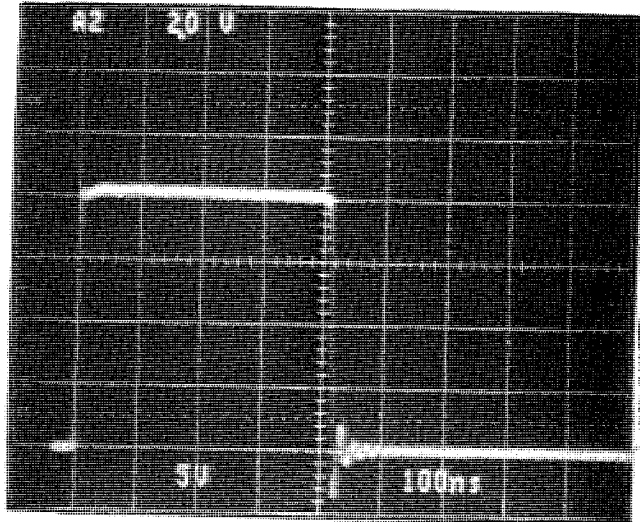

8.0 TROUBLESHOOTING**WARNING**

The HV1000 contains capacitors that are used as energy storage elements. When charged, these capacitors contain in excess of 1.5 joules of stored energy. This is sufficient energy to cause serious injury. **Assure that the AC power cord is disconnected from the pulser, and that the capacitor bank is fully discharged and a shorting strap installed before any repairs or adjustments are attempted.** Verify with a voltmeter that all circuits are de-energized before servicing. The voltmeter used to make these measurements must be certified for use at 1000VDC and 220VAC or greater. Dangerous voltages, floating ground planes and energy storage exist at several locations in the HV1000. Touching connections or components could result in serious injury.

8.1 Troubleshooting Procedures

Before attempting to service or troubleshoot the HV1000, review the servicing safety summary in Section 3.0.

The power MOSFET utilized in the HV1000 is mounted underneath the printed circuit board, and utilizes the case as a heat sink. In the unlikely event that the MOSFET need be replaced, it is highly recommended that the unit be returned to the factory for servicing.

The table below summarizes potential problems and their solutions. If these recommendations do not resolve the problem, DEI customer service can be contacted for further assistance.

<u>SYMPTOM</u>	<u>SOLUTIONS</u>
1. Red LED does not illuminate	-AC power not plugged in. -Fuse(s) are blown. See fuse replacement instructions in Section 8.1.1.
2. No output pulse.	-No input trigger. -Input trigger voltage too low. -Input trigger pulse width too short. Increase width. -Input trigger frequency too high. Reduce frequency. -No input high voltage. Check HV supply and connections. -Output not connected correctly. Check all cables and connections.

-Pulser is damaged. Contact
DEI customer service.

8.1.1 Fuses

To avoid fire hazard or damage to the pulser, use only 3A fast blow fuses (Littlefuse #312003 or equivalent). Fuse replacement should be performed by qualified personnel only. **Assure that the AC power cord is disconnected from the pulser, and that the capacitor bank is fully discharged and a shorting strap installed before fuse replacement is attempted.** Verify with a voltmeter that all circuits are de-energized before servicing. The voltmeter used to make these measurements must be certified for use at 1000VDC and 220VAC or greater.

The fuses are located in the corner of the printed circuit board, adjacent to the power entry module.

8.2 Factory Service

If the procedures above fail to resolve an operational problem, please contact the factory for further assistance:

DIRECTED ENERGY, INC.
2301 RESEARCH BLVD
SUITE 105
FORT COLLINS, CO 80526
(303) 493-1901
FAX (303) 493-1903

9.0 SYSTEM FAILURE MODES

The HV1000 pulse generator is capable of generating large amplitude current pulses with very fast rise and fall times. **There is no over-current or over-voltage protection circuitry**, and it is the user's responsibility to assure that the interconnect cables and load do not create transients, over-current or over-voltage conditions that could damage the pulse generator. **FAILURE TO DO SO VOIDS THE WARRANTY.**

9.1 Over-Current Failure

When the output is shorted, the HV1000 can deliver up to 200A of current (depending on cabling, HV power supply setting, etc.). A current pulse of this magnitude is far in excess of the generator's maximum specification, and may cause damage to the pulse generator, load and/or associated cabling.

The output can be shorted by allowing the two output leads to touch each other, the "hot" lead to contact ground, load arcing, or a shorted load.

9.2 Over-Voltage Failure

One may incorrectly assume that the voltage across the MOSFET switching device could never exceed the 950V maximum input high voltage. It is possible to create voltages in excess of 950V by driving an open cable or by generating $L di/dt$ spikes.

From transmission line theory it is known that a voltage pulse launched onto an open cable will cause the voltage to reflect back down the cable and double in amplitude. This voltage doubling will over-voltage the MOSFET and lead to pulse generator failure. Turning on the pulse generator with the load disconnected or opening the load while the pulse generator is operating may cause it to fail due to this voltage doubling effect.

$L di/dt$ spikes are created when current flowing through an inductor is interrupted (i.e. current is turned off). The amplitude of the resultant voltage spike is defined by the formula:

$$V = L di/dt,$$

where L is the circuit inductance, di is the current value at turn off and dt is the time it takes for the current to get to zero (i.e. fall time). By monitoring the voltage output of the pulse generator, the user can measure $L di/dt$ voltage spikes. With this measurement, the user can determine the actual voltage across the MOSFET switching device, with the formula:

$$V_{\max} = [L di/dt] + V_{\text{supply}}$$

where

$L di/dt$ = peak of the negative-going spike;
 V_{supply} = panel meter voltage;
 V_{\max} = 950 volts.

Any time the test setup (e.g. interconnect cables and/or load resistance) is changed, it will be necessary to again verify that V_{\max} is no greater than 950 volts.

10.0 WARRANTY

Directed Energy, Inc. (DEI) warrants all parts of equipment of its manufacture to be free from defects caused by faulty material or poor workmanship. Directed Energy, Inc.'s obligation is limited under the warranty to repair or replacement of products in kind. Returns must be accompanied by a Directed Energy, Inc. return authorization number and conform to standard conditions for adjustment. The aforesaid warranty shall expire twelve (12) months following the day of shipment from Directed Energy, Inc.'s plant. The foregoing states the entire warranty extended by Directed Energy, Inc. No other warranty, expressed or implied, is made and, specifically, Directed Energy, Inc. makes no warranty of merchantability or fitness for any purpose. In no case shall Directed Energy, Inc. be liable for any special or consequential damages. Authorization must be obtained prior to return of defective items.

APPENDIX A

SCHEMATICS

REV	EC	DESCRIPTION	DATE	BY	CHKD	ENG
01	-	ORIGINAL ISSUE				
A2	-	COMPONENT UPDATES	3/21/91	RS	GK	
A3	-	HVX UPDATES, NEW TITLE	7/26/91	RS	GK	

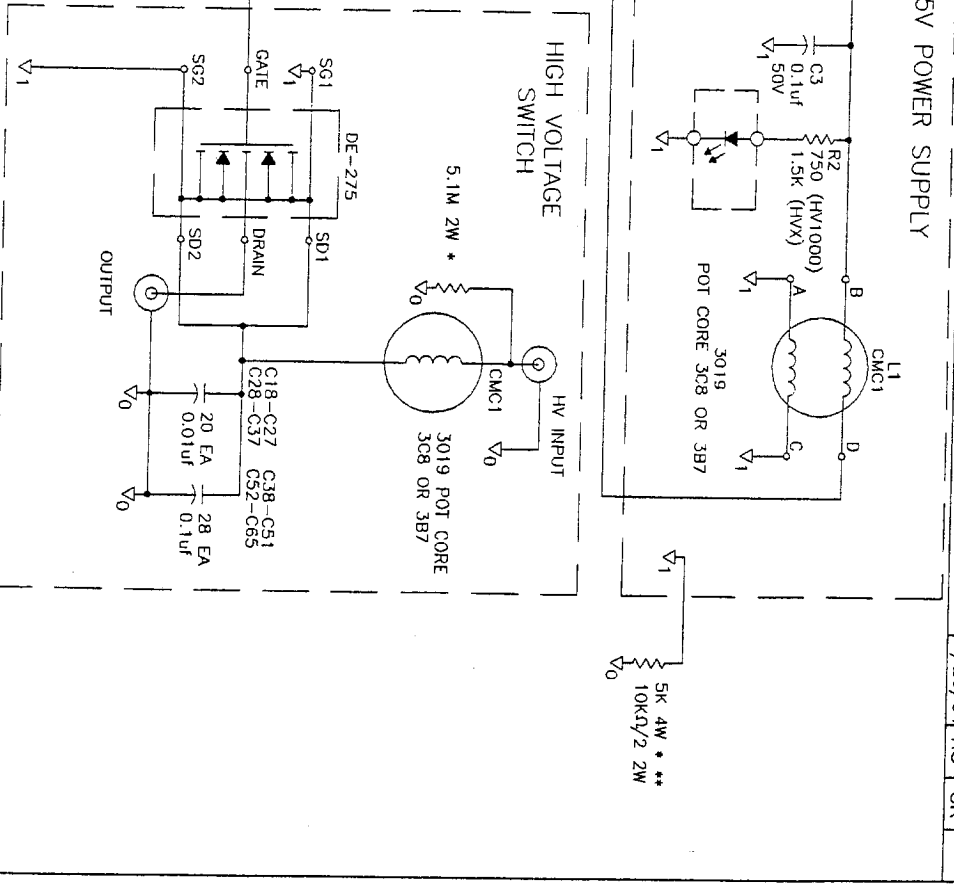
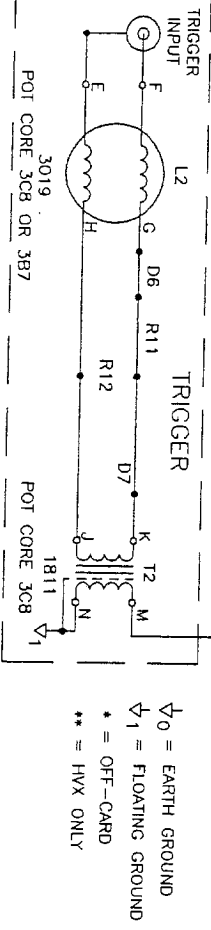
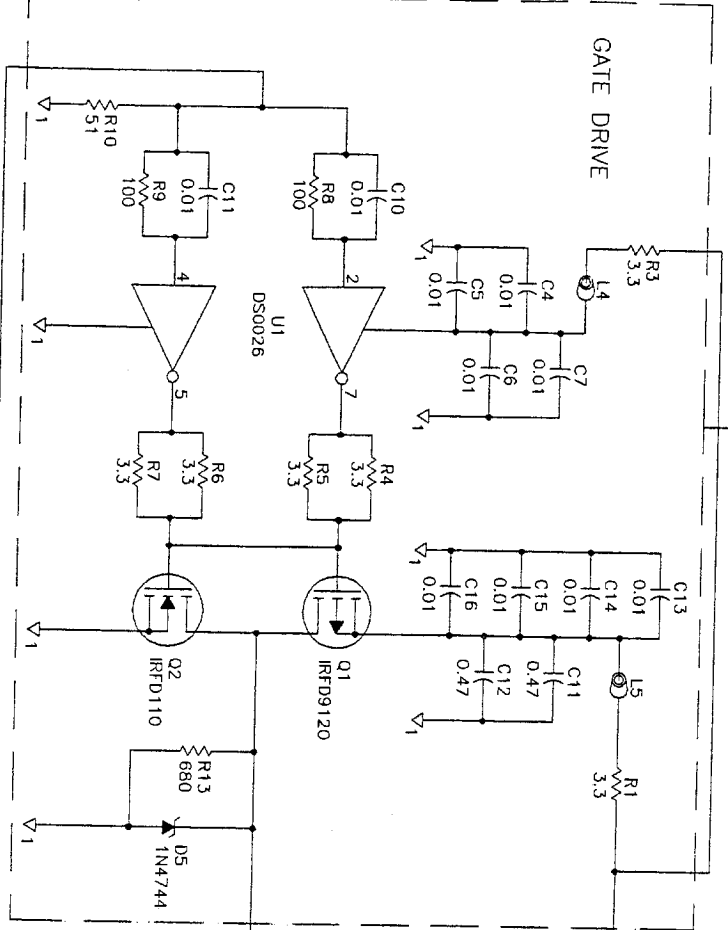
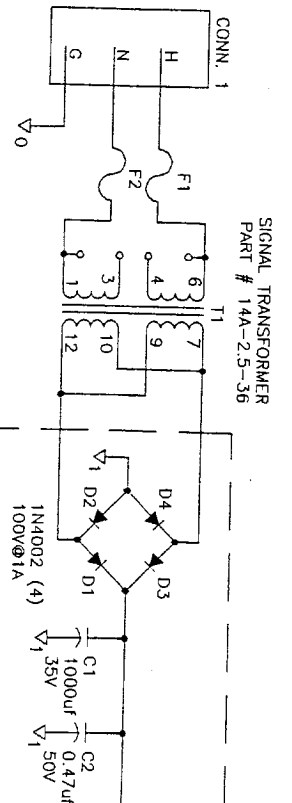

NOTICE
THIS DOCUMENT CONTAINS PROPRIETARY INFORMATION OF DIRECTED ENERGY, INC. AND IS UNCLASSIFIED. IT IS NOT TO BE USED OR DISCLOSED TO ANYONE FOR THE PURPOSES OF RESEARCH, DEVELOPMENT, PRODUCTION, OR SALE OF ANY ARTICLE WITHOUT THE WRITTEN PERMISSION OF DIRECTED ENERGY, INC.

CONTRACT NO.		TITLE		SCALE	
DRAWN	DATE	HV1000/HVX NEGATIVE PULSE MODULE SCHEMATIC		SCALE	RELEASE DATE
CAD/C SERVICES	2/5/90			A	
CHECK					
R. D. SHERWOOD	2/12/90				
DESIGN					
DESIGN ACTIVITY					
CUSTOMER					
FCSM NO.		DWG NO.		REV	
		6040-0002		A3	
SHEET		1 OF 1			