



NXL series

**Constant and variable torque
Variable Speed Drives
for induction motors**

Subject to changes without notice

AT LEAST THE 10 FOLLOWING STEPS OF THE *START-UP QUICK GUIDE* MUST BE PERFORMED DURING THE INSTALLATION AND COMMISSIONING.

IF ANY PROBLEMS OCCUR, PLEASE CONTACT YOUR LOCAL DISTRIBUTOR.

Start-up Quick Guide

1. Check that the delivery corresponds to your order, see Chapter 3.
2. Before taking any commissioning actions read carefully the safety instructions in Chapter 1.
3. Before the mechanical installation, check the minimum clearances around the unit and check the ambient conditions in Chapter 5.
4. Check the size of the motor cable, mains cable, mains fuses and check the cable connections, read Chapter 6.
5. Follow the installation instructions, see Chapter 5.
6. Control cable sizes and the grounding system are explained in Chapter 6.2.1.
7. Instructions on using the keypad are given in Chapter 7.
8. All parameters have factory default values. In order to ensure proper operation, check the rating plate data for the values below and the corresponding parameters of parameter group P2.1. See Chapter 8.3.2.
 - nominal voltage of the motor, par. 2.1.6
 - nominal frequency of the motor, par. 2.1.7
 - nominal speed of the motor, par 2.1.8
 - nominal current of the motor, par. 2.1.9
 - motor $\cos\phi$, par. 2.1.10

All parameters are explained in the Multi-Control Application Manual.

9. Follow the commissioning instructions, see Chapter 8.
10. The NXL Frequency Converter is now ready for use.
11. In the end of this manual, you will find a quick help with the default I/O, control panel menus, monitoring values, fault codes and basic parameters

The Manufacturer is not responsible for the use of the frequency converters against the instructions.

CONTENTS

NXL USER'S MANUAL

INDEX

1	SAFETY
2	EU DIRECTIVE
3	RECEIPT OF DELIVERY
4	TECHNICAL DATA
5	INSTALLATION
6	CABLING AND CONNECTIONS
7	CONTROL KEYPAD
8	COMMISSIONING
9	FAULT TRACING
10	DESCRIPTION OF BOARD NXOPTAA

MULTI-CONTROL APPLICATION MANUAL

ABOUT THE NXL USER'S MANUAL AND THE MULTI-CONTROL APPLICATION MANUAL

Congratulations for choosing the Smooth Control provided by NXL frequency converters!

The User's Manual will provide you with the necessary information about the installation, commissioning and operation of NXL Frequency Converter. We recommend that you carefully study these instructions before powering up the frequency converter for the first time.

In the Multi-Control Application Manual you will find information about the application used in the NXL General Purpose Drive.

This manual is available in both paper and electronic editions. We recommend you to use the electronic version if possible. If you have the **electronic version** at your disposal you will be able to benefit from the following features:

The manual contains several links and cross-references to other locations in the manual which makes it easier for the reader to move around in the manual, to check and find things faster.

The manual also contains hyperlinks to web pages. To visit these web pages through the links you must have an internet browser installed on your computer.

NOTE: You will not be able to edit the Microsoft Word version of the manual without a valid password. Open the manual file as a read-only version.

NXL User's Manual

Index

1. SAFETY	6
1.1 WARNINGS.....	6
1.2 SAFETY INSTRUCTIONS.....	6
1.3 EARTHING AND EARTH FAULT PROTECTION.....	6
1.4 RUNNING THE MOTOR.....	7
2. EU DIRECTIVE	8
2.1 CE MARKING.....	8
2.2 EMC DIRECTIVE.....	8
2.2.1 <i>General</i>	8
2.2.2 <i>Technical criteria</i>	8
2.2.3 <i>NXL frequency converter EMC classification</i>	8
2.2.4 <i>The installation of an external RFI filter</i>	10
2.2.5 <i>Manufacturer's declaration of conformity</i>	10
3. RECEIPT OF DELIVERY	12
3.1 TYPE DESIGNATION CODE.....	12
3.2 STORAGE.....	12
3.3 MAINTENANCE.....	13
3.4 WARRANTY.....	13
4. TECHNICAL DATA	14
4.1 INTRODUCTION.....	14
4.2 POWER RATINGS.....	15
4.2.1 <i>NXL – Mains voltage 208 – 240 V</i>	15
4.2.2 <i>NXL – Mains voltage 380 – 500 V</i>	15
4.3 TECHNICAL DATA.....	16
5. INSTALLATION	18
5.1 MOUNTING.....	18
5.2 COOLING.....	23
5.3 CHANGING EMC PROTECTION CLASS FROM H TO T.....	24
6. CABLING AND CONNECTIONS	25
6.1 POWER CONNECTIONS.....	25
6.1.1 <i>Cabling</i>	27
6.1.1.1 Cable and fuse sizes.....	27
6.1.2 <i>Installation instructions</i>	28
6.1.2.1 Stripping lengths of motor and mains cables.....	29
6.1.2.2 Installation of cables to NXL.....	30
6.1.3 <i>Cable installation and the UL standards</i>	34
6.1.4 <i>Cable and motor insulation checks</i>	34
6.2 CONTROL UNIT.....	35
6.2.1 <i>Control connections</i>	35
6.2.2 <i>Control cables</i>	36
6.2.2.1 Control I/O.....	36
6.2.3 <i>Control terminal signals</i>	37
6.2.3.1 Jumper selections on NXL basic board.....	38

7.	CONTROL KEYPAD	41
7.1	INDICATIONS ON THE KEYPAD DISPLAY.....	41
7.1.1	<i>Drive status indications</i>	41
7.1.2	<i>Control place indications</i>	42
7.1.3	<i>Numeric indications</i>	42
7.2	KEYPAD PUSH-BUTTONS.....	43
7.2.1	<i>Button descriptions</i>	43
7.3	NAVIGATION ON THE CONTROL KEYPAD.....	44
7.3.1	<i>Monitoring menu (M1)</i>	48
7.3.2	<i>Parameter menu (P2)</i>	50
7.3.3	<i>Keypad control menu (K3)</i>	52
7.3.3.1	Selection of control place.....	52
7.3.3.2	Keypad reference.....	53
7.3.3.3	Keypad direction.....	53
7.3.3.4	Stop button activation.....	53
7.3.4	<i>Active faults menu (F4)</i>	54
7.3.4.1	Fault types.....	54
7.3.4.2	Fault codes.....	55
7.3.5	<i>Fault history menu (H5)</i>	58
7.3.6	<i>System menu (S6)</i>	59
7.3.6.1	Copy parameters.....	61
7.3.6.2	Security.....	61
7.3.6.3	Keypad settings.....	62
7.3.6.4	Hardware settings.....	63
7.3.6.5	System information.....	65
7.3.6.6	AI mode.....	67
7.3.6.7	Fieldbus parameters.....	67
7.3.7	<i>Expander board menu (E7)</i>	69
7.4	FURTHER KEYPAD FUNCTIONS.....	69
8.	COMMISSIONING	70
8.1	SAFETY.....	70
8.2	COMMISSIONING OF THE FREQUENCY CONVERTER.....	70
8.3	BASIC PARAMETERS.....	73
8.3.1	<i>Monitoring values (Control keypad: menu M1)</i>	73
8.3.2	<i>Basic parameters (Control keypad: Menu P2 → B2.1)</i>	74
9.	FAULT TRACING	76
10.	DESCRIPTION OF EXPANDER BOARD NXOPTAA	79



1. SAFETY



ONLY A COMPETENT ELECTRICIAN MAY CARRY OUT THE ELECTRICAL INSTALLATION



1.1 Warnings

 WARNING	1	The components of the power unit of the frequency converter are live when NXL is connected to mains potential. Coming into contact with this voltage is extremely dangerous and may cause death or severe injury. The control unit is isolated from the mains potential.
	2	The motor terminals U, V, W (T1, T2, T3) and the DC-link/brake resistor terminals -/+ (in NXL ≥ 1.1 kW) are live when NXL is connected to mains, even if the motor is not running.
	3	The control I/O-terminals are isolated from the mains potential. However, the relay outputs and other I/O-terminals may have a dangerous control voltage present even when NXL is disconnected from mains.
	4	The frequency converter has a large capacitive leakage current.
	5	If the frequency converter is used as a part of a machine, the machine manufacturer is responsible for providing the machine with a main switch (EN 60204-1).
	6	Only spare parts delivered by Honeywell can be used.
	 HOT SURFACE	7

1.2 Safety instructions

	1	The NXL frequency converter is meant for fixed installations only.
	2	Do not perform any measurements when the frequency converter is connected to the mains.
	3	After disconnecting the frequency converter from the mains, wait until the fan stops and the indicators on the display go out. Wait 5 more minutes before doing any work on NXL connections.
	4	Do not perform any voltage withstand tests on any part of NXL. There is a certain procedure according to which the tests shall be performed. Ignoring this procedure may result in damaged product.
	5	Prior to measurements on the motor or the motor cable, disconnect the motor cable from the frequency converter.
	6	Do not touch the IC-circuits on the circuit boards. Static voltage discharge may damage the components.

1.3 Earthing and earth fault protection

The NXL frequency converter must always be earthed with an earthing conductor connected to the earthing terminal .

Automation and Control Solutions

Honeywell
1985 Douglas Drive North
Golden Valley, MIN 55422

Honeywell Limited-Honeywell Limitée
35 Dynamic Drive
Scarborough, Ontario
M1V 4Z9

63-2599

www.honeywell.com

The earth fault protection inside the frequency converter protects only the converter itself against earth faults in the motor or the motor cable.

Due to the high capacitive currents present in the frequency converter, fault current protective switches may not function properly. If fault current protective switches are used they must be tested with the drive with earth fault currents that are possible to arise in fault situations.

1.4 Running the motor

Warning symbols

For your own safety, please pay special attention to the instructions marked with the following symbols:



= **Dangerous voltage**



= **General warning**



= **Hot surface – Risk of burn**

MOTOR RUN CHECK LIST

 WARNING	1	Before starting the motor, check that the motor is mounted properly and ensure that the machine connected to the motor allows the motor to be started.
	2	Set the maximum motor speed (frequency) according to the motor and the machine connected to it.
	3	Before reversing the motor shaft rotation direction make sure that this can be done safely.
	4	Make sure that no power correction capacitors are connected to the motor cable.
	5	Make sure that the motor terminals are not connected to mains potential.

Automation and Control Solutions

Honeywell
1985 Douglas Drive North
Golden Valley, MIN 55422

Honeywell Limited-Honeywell Limitée
35 Dynamic Drive
Scarborough, Ontario
M1V 4Z9

63-2599

www.honeywell.com

2. EU DIRECTIVE

2.1 CE marking

The CE marking on the product guarantees the free movement of the product within the EEA (European Economic Area). It also guarantees that the product meets the various requirements placed upon it (such as the EMC Directive and possibly other directives according to the so-called new procedure).

NXL frequency converters carry the CE label as a proof of compliance with the Low Voltage Directive (LVD) and the Electro Magnetic Compatibility (EMC). The company SGS FIMKO has acted as the Competent Body.

2.2 EMC directive

2.2.1 General

The EMC Directive provides that the electrical apparatus must not excessively disturb the environment they are used in, and, on the other hand, it shall have an adequate level of immunity toward other disturbances from the same environment.

The compliance of NXL frequency converters with the EMC directive is verified with Technical Construction Files (TCF) checked and approved by SGS FIMKO, which is a Competent Body. The Technical Construction Files are used to authenticate the conformity of NXL frequency converters with the Directive because such a large-sized product family is impossible to be tested in a laboratory environment and because the combinations of installation vary greatly.

2.2.2 Technical criteria

EMC compliance is a major consideration for NXL drives from the outset of the design. NXL frequency converters are marketed throughout the world, a fact which makes the EMC requirements of customers different. As far as the immunity is concerned, all NXL frequency converters are designed to fulfil even the strictest requirements, while as regards the emission level, the customer may want to upgrade Vacon's already high ability to filter electro-magnetic disturbances.

2.2.3 NXL frequency converter EMC classification

NXL frequency converters are divided into two classes according to the level of electromagnetic disturbances emitted. There is no difference in the functions or the control electronics between these classes but their EMC properties vary as follows:

Class N:

No EMC emission protection. NXL frames MF2 and MF3 are delivered from the factory without an external RFI filter as class N products.

Class H:

With an external **RFI filter** (option) installed NXL frequency converters MF2 and MF3 **fulfil the requirements of the product standard EN 61800-3 + A11 for the 1st environment restricted distribution and the 2nd environment.**

The emission levels correspond to the requirements of EN 61000-6-4.

All NX frequency converters fulfil all EMC immunity requirements (standards EN 61000-6-1, 61000-6-2 and EN 61800-3).

Automation and Control Solutions

Honeywell
1985 Douglas Drive North
Golden Valley, MIN 55422

Honeywell Limited-Honeywell Limitée
35 Dynamic Drive
Scarborough, Ontario
M1V 4Z9

63-2599

www.honeywell.com

2.2.4 The installation of an external RFI filter

The EMC protection class of NXL frequency converters MF2 and MF3 can be changed from **N** to **H** with an optional external RFI filter. Install the power cables in terminals L1, L2 and L3 and the grounding cable in terminal PE of the filter. See figure below. See also mounting instructions of MF2 in Figure 5-2.

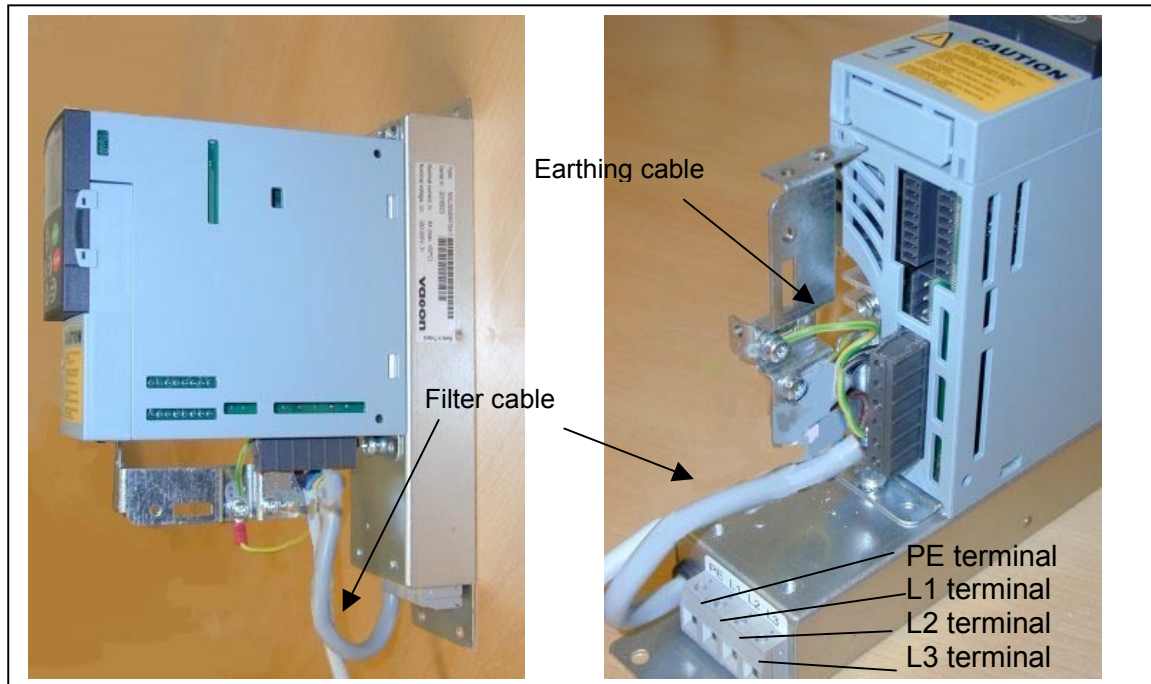

Figure 2-1. MF2 with an RFI filter

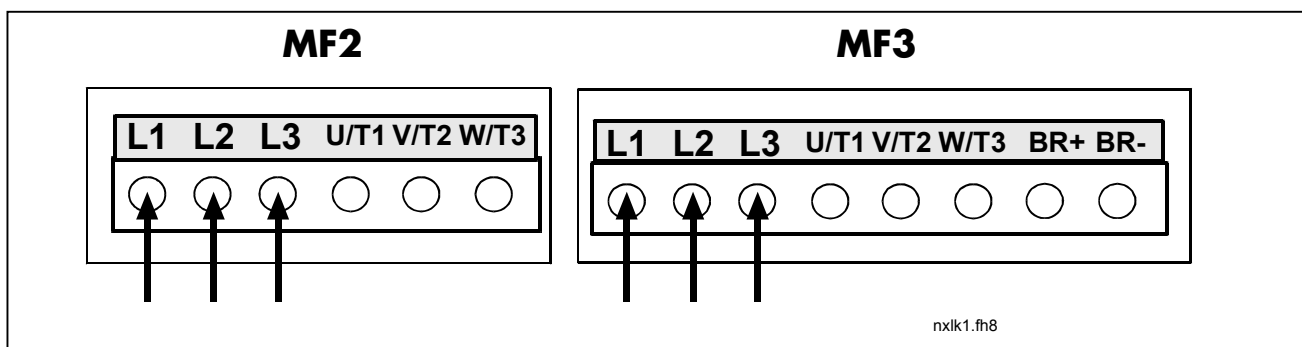

Figure 2-2. Connection of RFI filter cable in NXL

2.2.5 Manufacturer's declaration of conformity

The following page presents the photocopy of the Manufacturer's Declaration of Conformity assuring the compliance of NXL frequency converters with the EMC-directives.

EU DECLARATION OF CONFORMITY

We

Manufacturer's name: Vacon PLC
Manufacturer's address: P.O.Box 25
Runsorintie 7
FIN-65381 Vaasa
Finland

hereby declare that the product

Product name: Single Board General Purpose Drive
Model designation: NXL0001 5...to 0032 5...

has been designed and manufactured in accordance with the following standards:

Safety: EN 50178 (1997), EN 60204-1 (1996)
EN 60950 (3rd edition 2000, as relevant)

EMC: EN 61800-3 (1996)+A11(2000), EN
61000-6-2 (1999), EN 61000-6-4 (2001)

and conforms to the relevant safety provisions of the Low Voltage Directive (73/23/EEC) as amended by the Directive (93/68/EEC) and EMC Directive 89/336/EEC.

It is ensured through internal measures and quality control that the product conforms at all times to the requirements of the current Directive and the relevant standards.

In Vaasa, 6th of September, 2002



Vesa Laisi
President

The year the CE marking was affixed: 2002

3. RECEIPT OF DELIVERY

NXL frequency converters have undergone scrupulous tests and quality checks at the factory before they are delivered to the customer. However, after unpacking the product, check that no signs of transport damages are to be found on the product and that the delivery is complete (compare the type designation of the product to the code below, Figure 3-1).

Should the drive have been damaged during the shipping, please contact primarily the cargo insurance company or the carrier.

If the delivery does not correspond to your order, contact the supplier immediately.

3.1 Type designation code

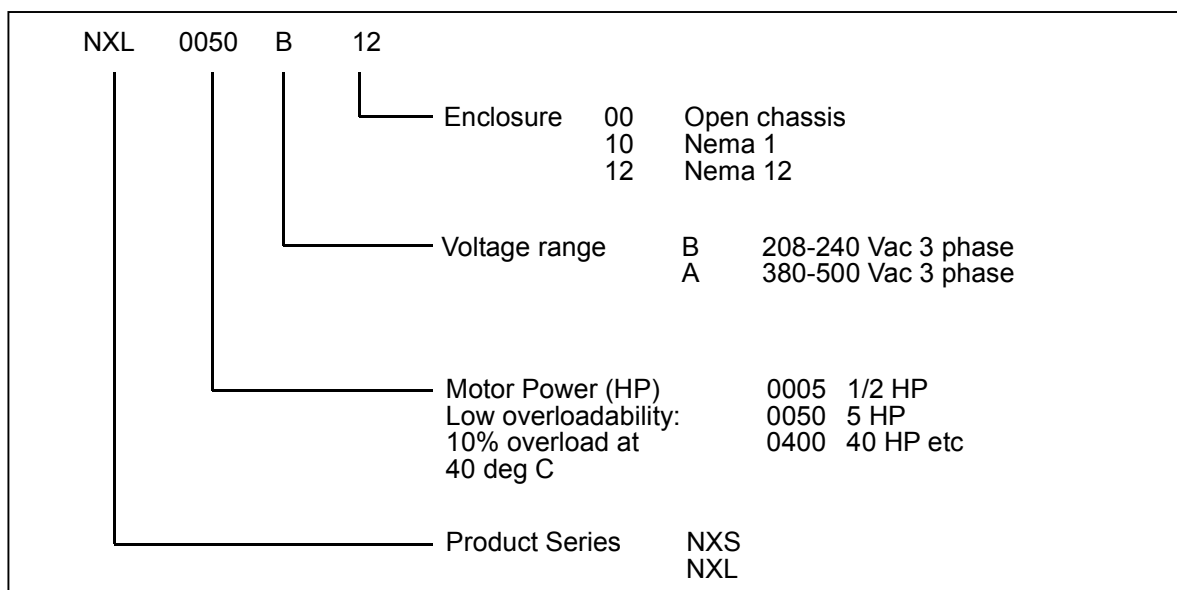

Figure 3-1. NXL type designation code

3.2 Storage

If the frequency converter is to be kept in store before use make sure that the ambient conditions are acceptable:

Storing temperature $-40 \dots +70^{\circ}\text{C}$
Relative humidity $<95\%$, no condensation

Automation and Control Solutions

Honeywell
1985 Douglas Drive North
Golden Valley, MIN 55422

Honeywell Limited-Honeywell Limitée
35 Dynamic Drive
Scarborough, Ontario
M1V 4Z9

63-2599

www.honeywell.com

3.3 Maintenance

In normal conditions, NXL frequency converters are maintenance-free. However, we recommend to clean the heatsink (using e.g. a small brush) whenever necessary.

NXL drives from 2.2kW are equipped with a cooling fan, which can easily be changed if necessary.

3.4 Warranty

Only manufacturing defects are covered by the warranty. The manufacturer assumes no responsibility for damages caused during or resulting from transport, receipt of the delivery, installation, commissioning or use.

The manufacturer shall in no event and under no circumstances be held responsible for damages and failures resulting from misuse, wrong installation, unacceptable ambient temperature, dust, corrosive substances or operation outside the rated specifications. Neither can the manufacturer be held responsible for consequential damages.

The Manufacturer's time of warranty is 18 months from the delivery or 12 months from the commissioning whichever expires first (General Conditions NL92/Orgalime S92).

The local distributor may grant a warranty time different from the above. This warranty time shall be specified in the distributor's sales and warranty terms. The manufacturer assumes no responsibility for any other warranties granted by offers.

In all matters concerning the warranty, please contact first your distributor.

Automation and Control Solutions

Honeywell
1985 Douglas Drive North
Golden Valley, MIN 55422

Honeywell Limited-Honeywell Limitée
35 Dynamic Drive
Scarborough, Ontario
M1V 4Z9

63-2599

www.honeywell.com

4. TECHNICAL DATA

4.1 Introduction

NXL is a compact, small-sized frequency converter with the output ranging from 220 W to 30 kW. It is well adapted for HVAC and OEM applications where its possibilities of use are almost unlimited.

The Motor and Application Control Block is based on microprocessor software. The microprocessor controls the motor basing on the information it receives through measurements, parameter settings, control I/O and control keypad. The motor and application control block controls the motor control microprocessor which, in turn, calculates the IGBT positions. Gate drivers amplify these signals for driving the IGBT inverter bridge.

The control keypad constitutes a link between the user and the frequency converter. The control keypad is used for parameter setting, reading status data and giving control commands. Instead of the control keypad, also a PC can be used to control the frequency converter if connected through a cable and a serial interface adapter (optional equipment).

You can have your NXL drive equipped with control I/O boards NXOPTAA, NXOPTB_ or NXOPTC_.

All other sizes but MF2 have an internal brake chopper. For closer information, contact the Manufacturer or your local distributor (see back cover). The input EMC filters are available as options externally for MF2 and MF3. In other sizes the filters are internal and included as standard.

The NXL frequency converters are professional drives intended to be connected to industrial networks. They should not be connected to public low-voltage distribution systems. This is a product of the restricted sales distribution class according to IEC 61800-3. In a domestic environment this product may cause radio interference in which case the user may be required to take adequate measures.

Sizes MF4 – MF6:

The three-phase AC-choke at the mains end together with the DC-link capacitor form an LC-filter, which, again, together with the diode bridge produce the DC-voltage supply to the IGBT Inverter Bridge block. The AC-choke also functions as a filter against High Frequency disturbances from the mains as well as against those caused by the frequency converter to the mains. It, in addition, enhances the waveform of the input current to the frequency converter. The entire power drawn by the frequency converter from the mains is active power.

The IGBT Inverter Bridge produces a symmetrical, 3-phase PWM-modulated AC-voltage to the motor.

Automation and Control Solutions

Honeywell
1985 Douglas Drive North
Golden Valley, MIN 55422

Honeywell Limited-Honeywell Limitée
35 Dynamic Drive
Scarborough, Ontario
M1V 4Z9

63-2599

www.honeywell.com

4.2 Power ratings

4.2.1 NXL – Mains voltage 208 – 240 V

Power range 0.25kW – 1,5kW as 1/3-phase

Mains voltage 230 V, 50/60 Hz, 3~ Series NXL IP00 (open chassis), EMC-level N								
Frequency converter type	Motor shaft power (230V) and current					Mechanical size Enclosure and protection class	Dimensions WxHxD (inch)	Weight
	Low overload		High overload					
	P [Hp] (500V)	I(L)	P [Hp] (500V)	I(H)	I(max)			
NXL 0005 B	0.5	2.4		1.7	2.6	MF2/IP00	2.36x5.12x5.67	35.27
NXL 0007 B	0.75	3.7	0.5	2.8	4.2	MF3/IP00	3.31x7.24x6.85	67.02
NXL 0010 B	1	4.8	0.75	3.7	5.6	MF3/IP00	3.31x7.24x6.85	67.02
NXL 0015 B	1.5	6.6	1	4.8	7.2	MF3/IP00	3.31x8.66x6.85	70.55

Table 4-1. Power ratings and dimensions of NXL, supply voltage 208—240V.

4.2.2 NXL – Mains voltage 380 – 500 V

Power range 0.37kW – 15kW as 3-phase

Mains voltage 380-500 V, 50/60 Hz, 3~ Series NXL IP00 (open chassis), EMC-level N								
Frequency converter type	Motor shaft power (500V) and current					Mechanical size Enclosure and protection class	Dimensions WxHxD (inch)	Weight
	Low overload		High overload					
	P [Hp] (500V)	I(L)	P [Hp] (500V)	I(H)	I(max)			
NXL 0007 A	0.75	1.9	0.5	1.3	2	MF2/IP00	2.36x5.12x5.67	35.27
NXL 0010 A	1	2.4	0.75	1.9	2.9	MF2/IP00	2.36x5.12x5.67	35.27
NXL 0015 A	1.5	3.3	1	2.4	3.6	MF3/IP00	3.31x7.24x6.85	67.02
NXL 0020 A	2	4.3	1.5	3.3	5	MF3/IP00	3.31x7.24x6.85	67.02
NXL 0030 A	3	5.4	2	4.3	6.5	MF3/IP00	3.31x8.66x6.85	70.55

NEMA1/12, EMC-level H								
NXL 0015 A	1.5	3.3	1	2.2	3.3	MF4/NEMA 1/12	5.04x11.5x7.48	11.02
NXL 0020 A	2	4.3	1.5	3.3	5	MF4/NEMA 1/12	5.04x11.5x7.48	11.02
NXL 0030 A	3	5.6	2	4.3	6.5	MF4/NEMA 1/12	5.04x11.5x7.48	11.02
NXL 0040 5	4	7.6	3	5.6	8.4	MF4/NEMA 1/12	5.04x11.5x7.48	11.02
NXL 0050 5	5	9	4	7.6	11.4	MF4/NEMA 1/12	5.04x11.5x7.48	11.02
NXL 0075 5	7.5	12	5	9	13.5	MF4/NEMA 1/12	5.04x11.5x7.48	11.02
NXL 0100 5	10	16	7.5	12	18	MF5/NEMA 1/12	5.67x15.4x8.43	17.86
NXL 0150 5	15	23	10	16	24	MF5/NEMA 1/12	5.67x15.4x8.43	17.86
NXL 0200 5	20	31	15	23	35	MF5/NEMA 1/12	5.67x15.4x8.43	17.86
NXL 0250 A	25	38	20	31	47	MF6/NEMA 1/12	7.68x20.4x9.33	40.79
NXL 0300 A	30	46	25	38	57	MF6/NEMA 1/12	7.68x20.4x9.33	40.79
NXL 0400 A	40	61	30	46	69	MF6/NEMA 1/12	7.68x20.4x9.33	40.79

Table 4-2. Power ratings and dimensions of NXL, supply voltage 380 – 500V.

Automation and Control Solutions

Honeywell
1985 Douglas Drive North
Golden Valley, MIN 55422

Honeywell Limited-Honeywell Limitée
35 Dynamic Drive
Scarborough, Ontario
M1V 4Z9

63-2599

www.honeywell.com

4.3 Technical data

Mains connection	Input voltage U_{in}	208...240V; 380...500V	
	Input frequency	45...66 Hz	
	Connection to mains	Once per minute or less (normal case)	
Motor connection	Output voltage	$0-U_{in}$	
	Continuous output current	I_H : Ambient temperature max. +50°C, overload 1.5 x I_H (1min/10min) I_L : Ambient temperature max. +40°C, overload 1.1 x I_L (1min/10min)	
	Starting torque	150% (Low overload); 200% (High overload)	
	Starting current	2 x I_H 2 secs every 20 secs, if output frequency <30Hz and temperature of heatsink <+60°C	
	Output frequency	0...320 Hz	
	Frequency resolution	0,01 Hz	
	Control characteristics	Control method	Frequency Control U/f Open Loop Sensorless Vector Control
Switching frequency (See parameter 2.6.8)		1...16 kHz; Factory default 6 kHz	
<u>Frequency reference</u> Analogue input		Resolution 0.1% (10bit), accuracy ±1%	
Keypad reference		Resolution 0.01 Hz	
Field weakening point		30...320 Hz	
Acceleration time		0...3000 sec	
Deceleration time		0...3000 sec	
Braking torque		DC-brake: 30%*TN (without brake option)	
Ambient conditions	Ambient operating temperature	-10°C (no frost)...+50°C: I_H -10°C (no frost)...+40°C: I_L	
	Storage temperature	-40°C...+70°C	
	Relative humidity	0...95% RH, non-condensing, non-corrosive, no dripping water	
	Air quality: - chemical vapours - mechanical particles	IEC 721-3-3, unit in operation, class 3C2 IEC 721-3-3, unit in operation, class 3S2	
	Altitude	100% load capacity (no derating) up to 1000m 1-% derating for each 100m above 1000m; max. 3000m	
	Vibration: EN50178/EN60068-2-6	5...150 Hz Displacement amplitude 1(peak) mm at 5...15.8 Hz Max acceleration amplitude 1 G at 15.8...150 Hz	
	Shock EN50178, IEC 68-2-27	UPS Drop Test (for applicable UPS weights) Storage and shipping: max 15 G, 11 ms (in package)	
	Enclosure class	IP20; MF2 and MF3. IP21; MF4 and bigger	
	EMC	Immunity	Complies with EN50082-1, -2, EN61800-3
		Emissions	Coded series complies with EN61800-3, restricted distribution. With an external filter attached compliance with EN50081-1, -2 and EN61800-3, unrestricted distribution

Technical data (continues on next page)

Safety		EN50178, EN60204-1, CE, UL, cUL, FI, GOST R, IEC 61800-5 (see unit nameplate for more detailed approvals)
Control connections	Analogue input voltage	0...+10V, $R_i = 200k\Omega$, Resolution 10 bit, accuracy $\pm 1\%$
	Analogue input current	0(4)...20 mA, $R_i = 250\Omega$ differential
	Digital inputs (3)	Positive logic; 18...24VDC
	Auxiliary voltage	+24V, $\pm 15\%$, max. 100mA
	Output reference voltage	+10V, $+3\%$, max. load 10mA
	Analogue output	0(4)...20mA; R_L max. 500 Ω ; resolution 10 bit; accuracy $\pm 5\%$
	Relay outputs	1 programmable change over relay output Switching capacity: 24VDC/8A, 250VAC/8A, 125VDC/0.4A
Protections	Overvoltage protection	NXL_2: 437VDC; NXL_5: 911VDC
	Undervoltage protection	NXL_2: 183VDC; NXL_5: 333VDC
	Earth-fault protection	In case of earth fault in motor or motor cable, only the frequency converter is protected
	Unit overtemperature protection	Yes
	Motor overload protection	Yes
	Motor stall protection	Yes
	Motor underload protection	Yes
	Short-circuit protection of +24V and +10V reference voltages	Yes
Overcurrent protection	Trip limit $4,0 \cdot I_H$ instantaneously	

Table 4- 3. Technical data

Automation and Control Solutions

Honeywell
1985 Douglas Drive North
Golden Valley, MIN 55422

Honeywell Limited-Honeywell Limitée
35 Dynamic Drive
Scarborough, Ontario
M1V 4Z9

63-2599

www.honeywell.com

5. INSTALLATION

5.1 Mounting

The NXL drive can be mounted on the wall or on the back plane of a cubicle. There are two possible positions in the wall mounting for the frames MF2 and MF3 (see Figure 5-1)

The NXL type MF2 is mounted with two screws using the middle holes of the mounting plates. If an RFI filter is used, the upper mounting plate shall be attached with two screws. MF3 and bigger types are always mounted with four screws, see Figure 5-2 and Figure 5-3.

Enough space shall be reserved above and underneath the frequency converter in order to ensure a sufficient cooling, see Figure 5-7, and Table 5-4. Also see to that the mounting plane is relatively even.

Below you will find the dimensions of NXL frequency converters with IP20 and IP21 enclosures on pages 20 -- 22.



Figure 5-1. The two possible mounting positions of NXL (MF2 and MF3)

Automation and Control Solutions

Honeywell
1985 Douglas Drive North
Golden Valley, MIN 55422

Honeywell Limited-Honeywell Limitée
35 Dynamic Drive
Scarborough, Ontario
M1V 4Z9

63-2599

www.honeywell.com

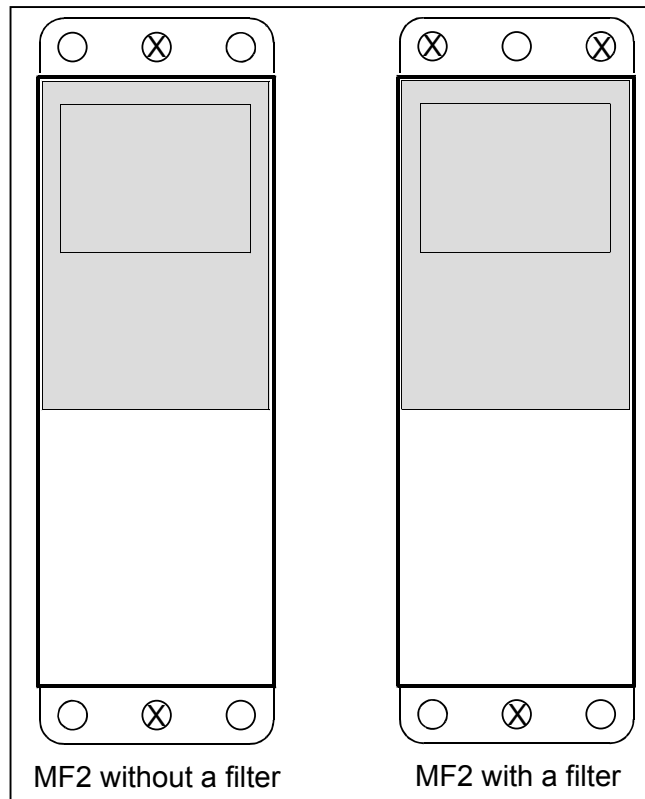

Figure 5-2. Mounting of NXL, MF2

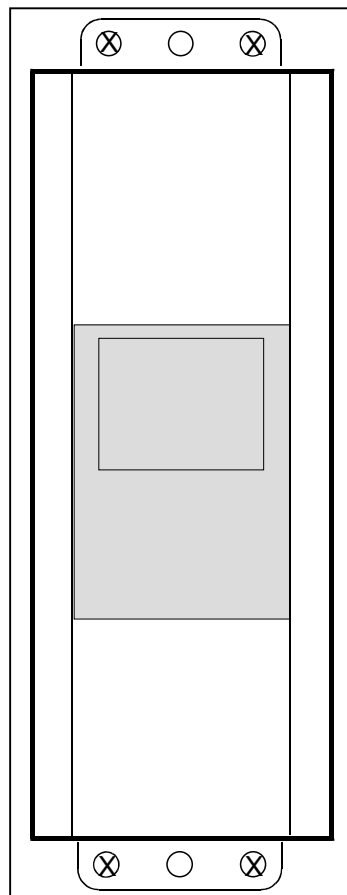

Figure 5-3. Mounting of NXL, MF3

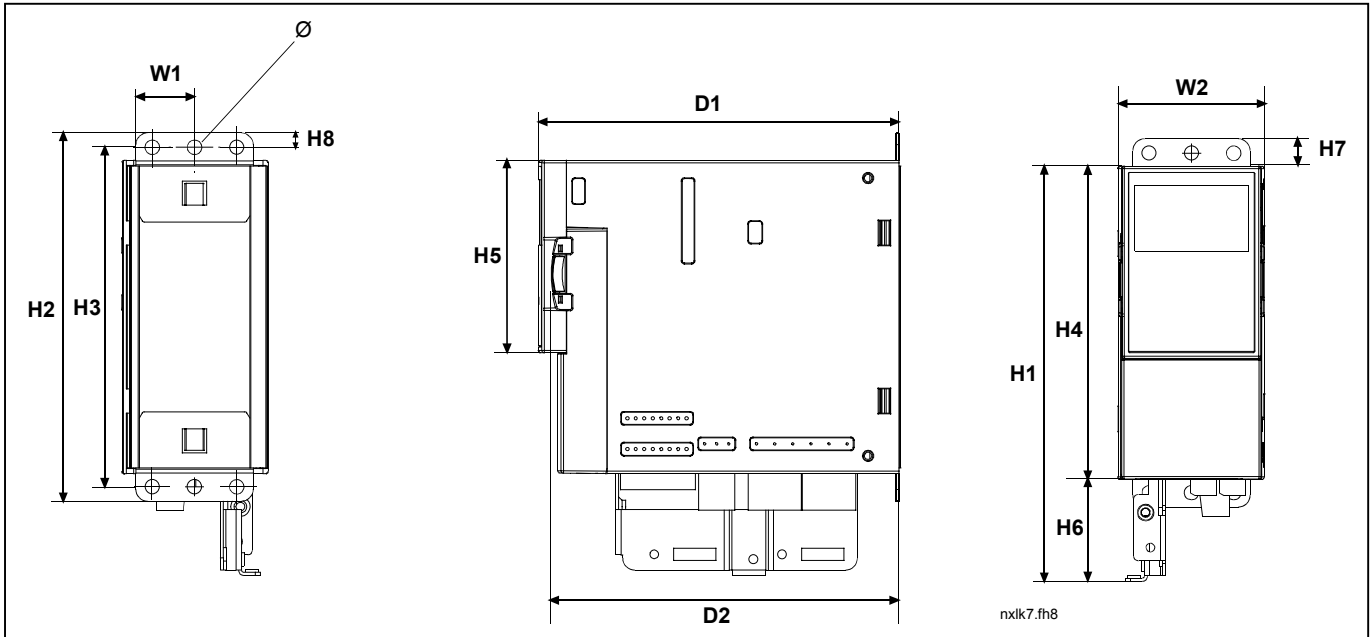

Figure 5-4. NXL dimensions, MF2

Type	Dimensions (inch)												
	W1	W2	H1	H2	H3	H4	H5	H6	H7	H8	D1	D2	∅
MF2	1.18	2.36	6.77	5.98	5.51	5.12	3.15	1.65	0.43	0.24	5.91	5.67	0.24

Table 5-1. Dimensions of NXL, MF2

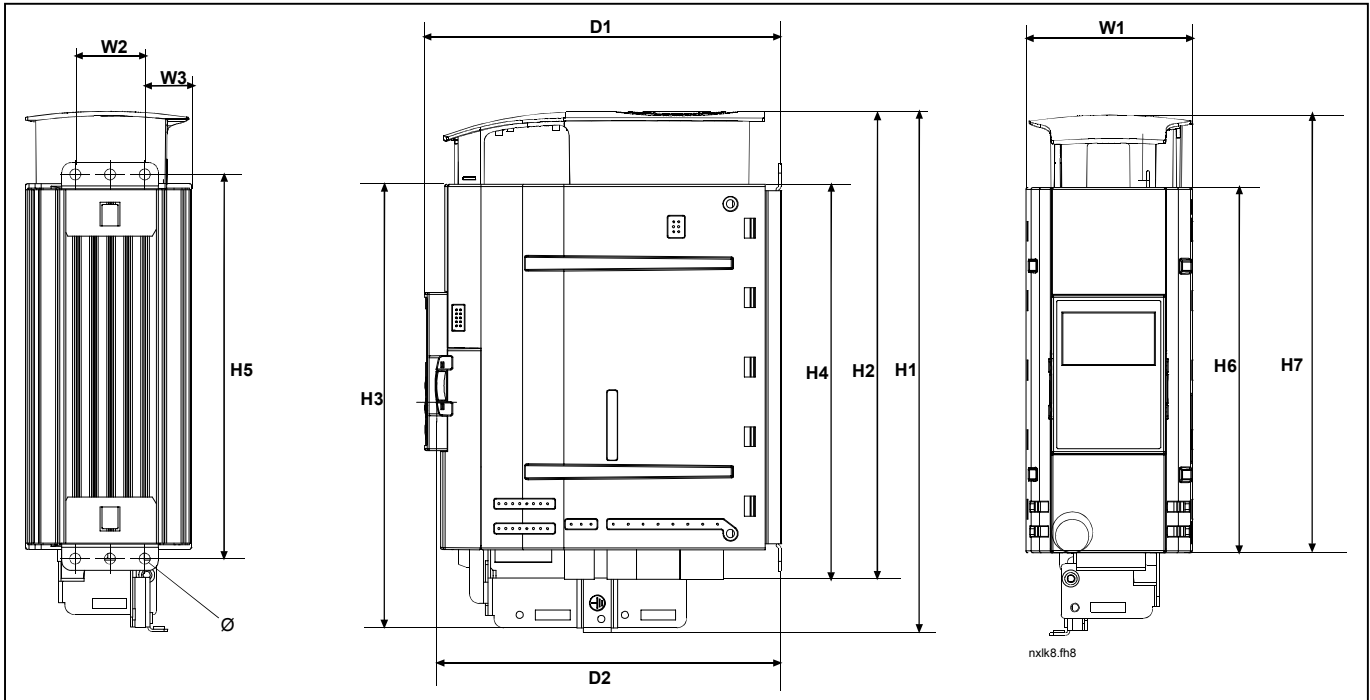

Figure 5-5. NXL dimensions, MF3

Type	Dimensions (inch)												
	W1	W2	W3	H1	H2	H3	H4	H5	H6	H7	D1	D2	Ø
MF3	3.31	1.38	0.91	10.31	9.25	8.78	7.83	7.60	7.24	8.66	6.77	6.54	0.24

Table 5-2. Dimensions of NXL, MF3

Automation and Control Solutions

Honeywell
 1985 Douglas Drive North
 Golden Valley, MIN 55422

Honeywell Limited-Honeywell Limitée
 35 Dynamic Drive
 Scarborough, Ontario
 M1V 4Z9

63-2599

www.honeywell.com

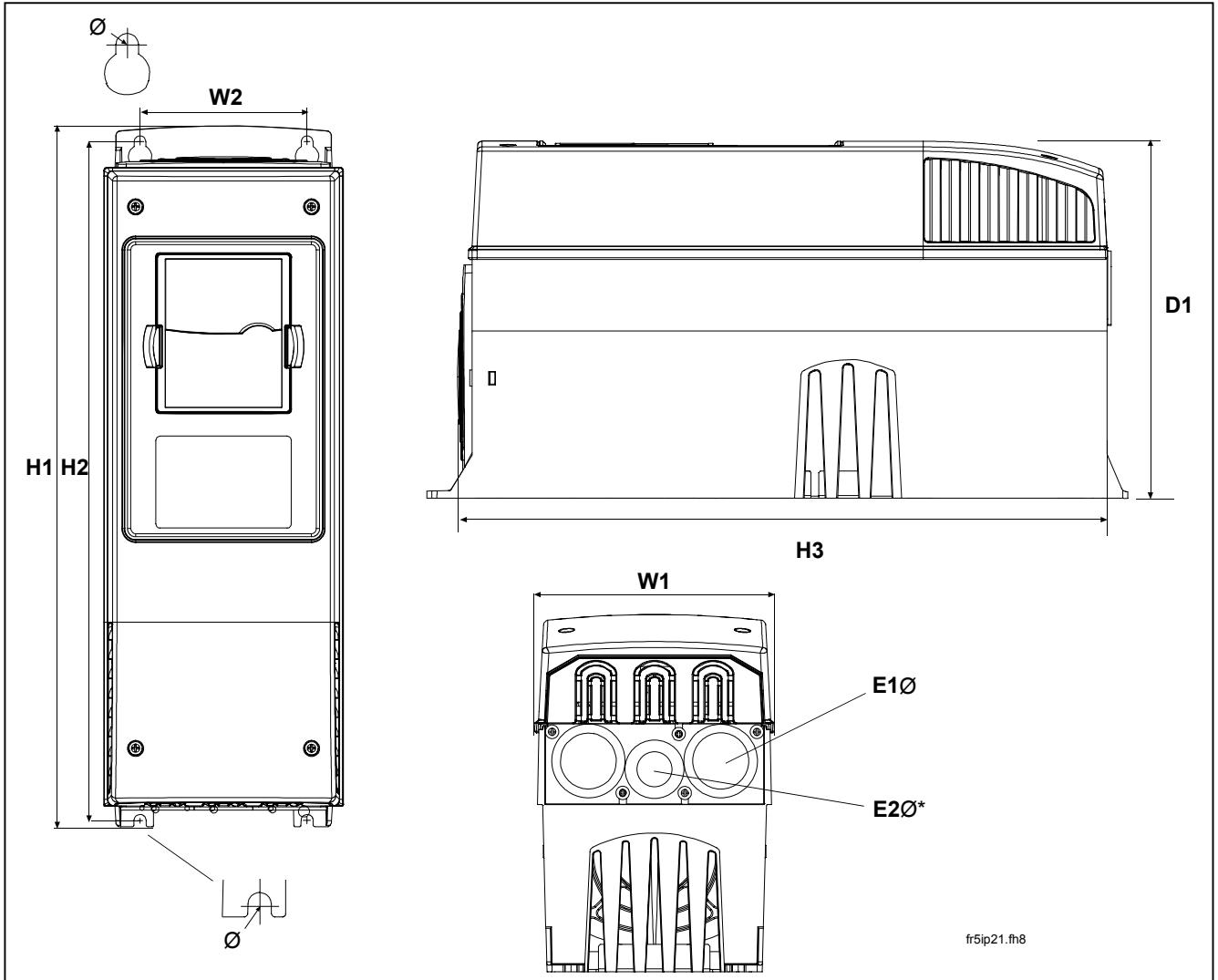

Figure 5-6. NXL dimensions, MF4 and MF5

Type	Dimensions								
	W1	W2	H1	H2	H3	D1	Ø	E1Ø	E2Ø*
MF4	5.04	3.94	12.87	12.32	11.5	7.48	0.28	3 x 1.11	
MF5	5.67	3.94	16.5	15.98	15.39	8.43	0.28	2 x 1.46	1 x 1.11

Table 5-3. Dimensions of NXL, MF4—MF5

* = MF5 only

5.2 Cooling

The cooling method in NXL drive is either convection or air cooling with a cooling fan. The cooling method for lower power ranges (frame MF2 and lower powers of MF3) is a convection type cooling. Forced air flow cooling is used for frames MF4, MF5, MF6 and higher powers of MF3.

Enough free space shall be left above and below the frequency converter to ensure sufficient air circulation and cooling. You will find the required dimensions for free space in the table below.

Type	Dimensions [inch]			
	A	B	C	D
NXL 0007-0010 A NXL 0005-0015 B			3.94	1.97
NXL 0015-0075 A	0.79	0.79	3.94	1.97
NXL 0100-0200 A	0.79	0.79	4.72	2.36
NXL 0250-0400 A	1.18	0.79	6.3	3.15

Table 5-4. Mounting space dimensions

- A** = clearance around the freq. converter (see also **B**)
- B** = distance from one frequency converter to another or distance to cabinet wall
- C** = free space above the frequency converter
- D** = free space underneath the frequency converter

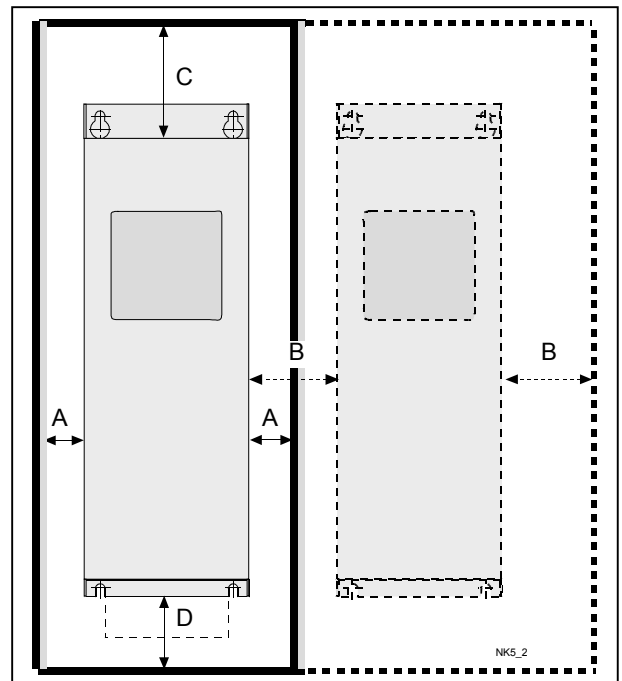

Figure 5-7. Installation space

Automation and Control Solutions

Honeywell
1985 Douglas Drive North
Golden Valley, MIN 55422

Honeywell Limited-Honeywell Limitée
35 Dynamic Drive
Scarborough, Ontario
M1V 4Z9

63-2599

www.honeywell.com

5.3 Changing EMC protection class from H to T

The EMC protection class of NXL frequency converter types MF4 and MF5 can be changed from **class H** to **class T** with a simple procedure presented in the figures below.

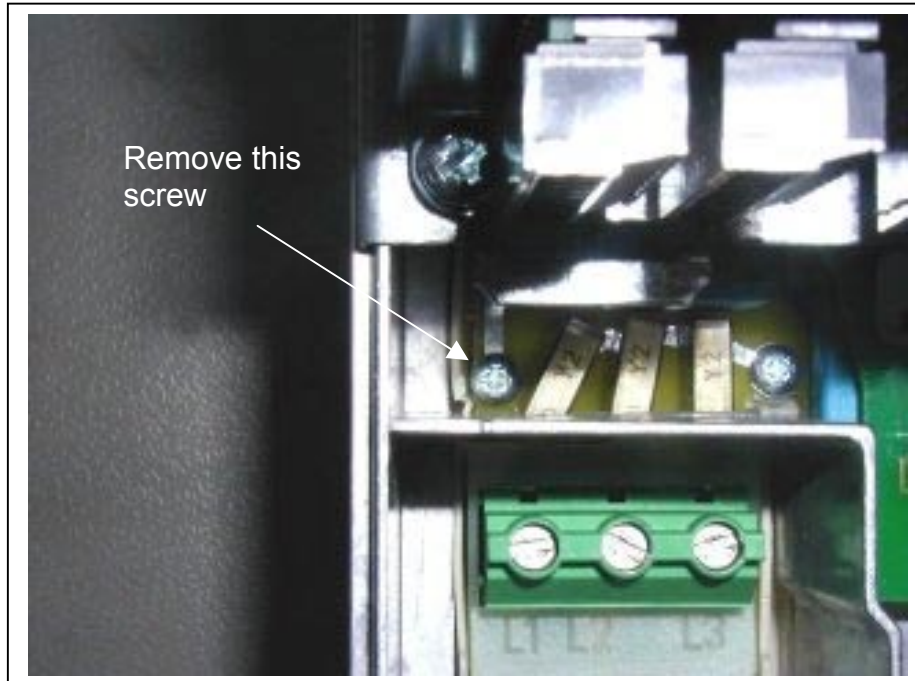

Figure 5-8. Changing of EMC protection class, MF4

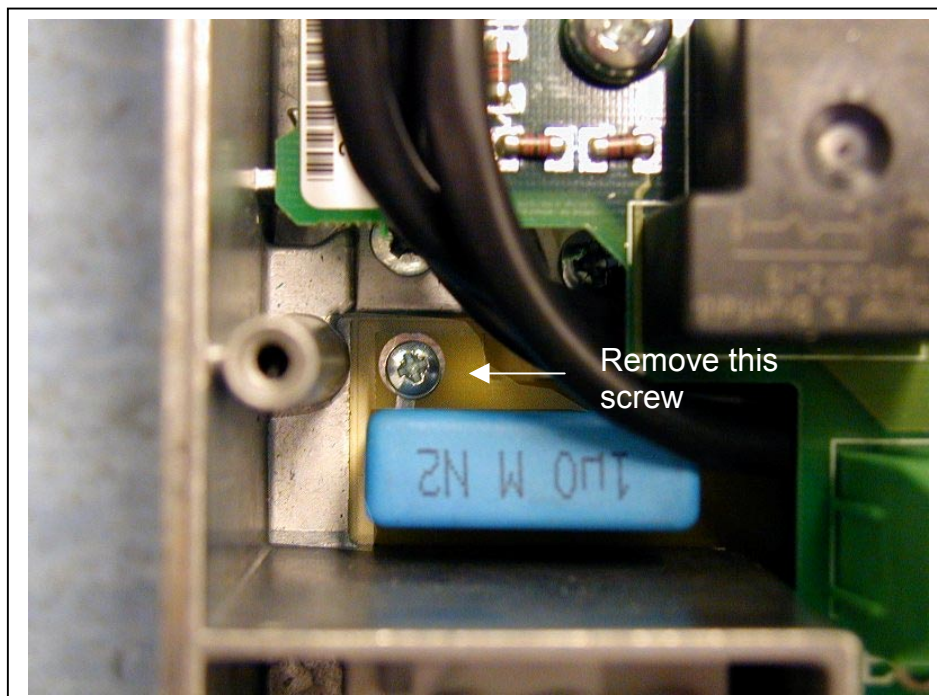

Figure 5-9. Changing of EMC protection class, MF5

6. CABLING AND CONNECTIONS

6.1 Power connections

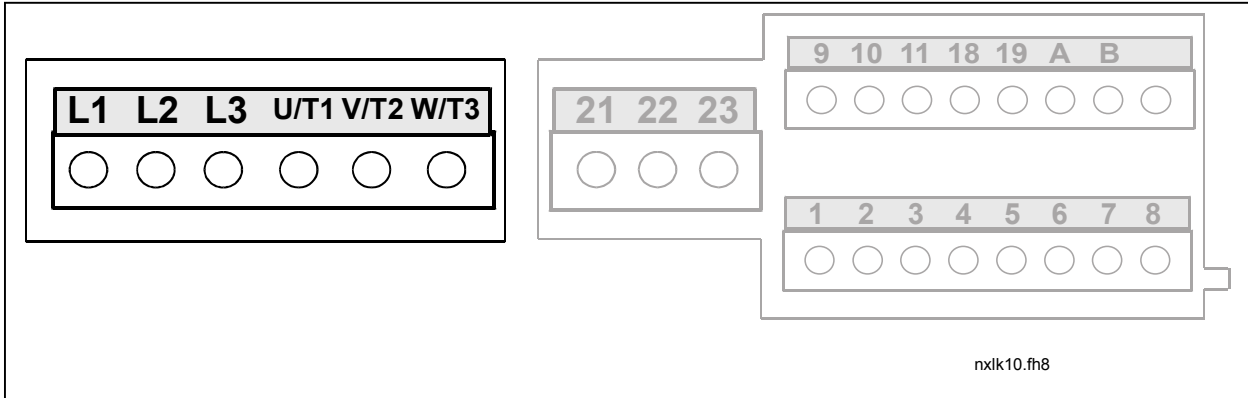

Figure 6-1. Power connections, MF2

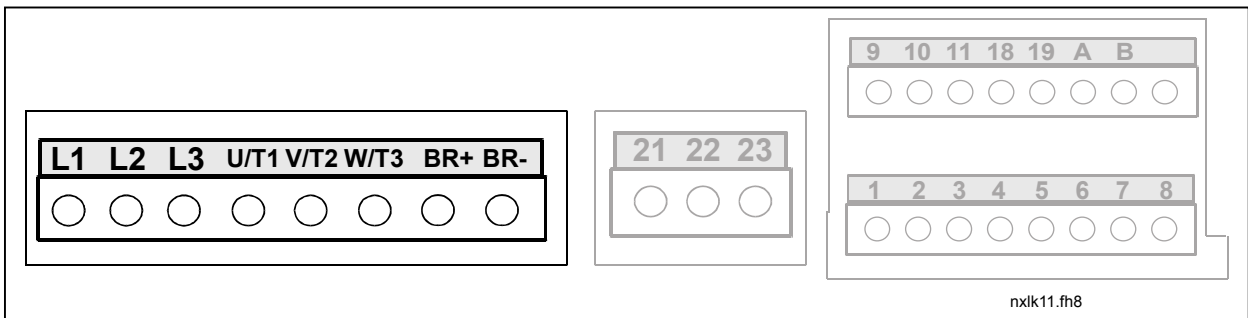

Figure 6-2. Power connections, MF3

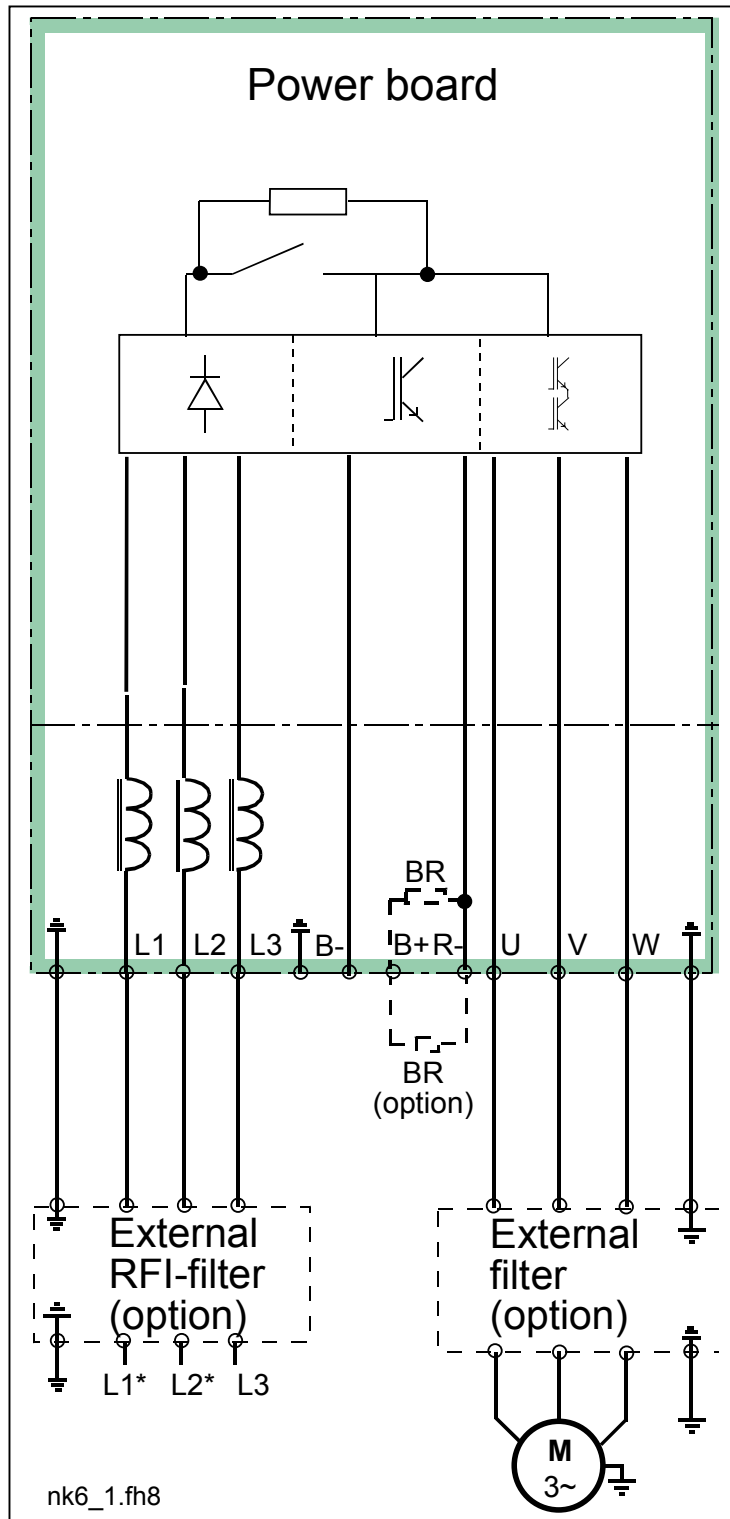

Figure 6-3. Principal wiring diagram of NXL5 power unit, MF4 to MF5

6.1.1 Cabling

Use cables with heat resistance of at least +60°C. The cables and the fuses must be dimensioned according to the frequency converter nominal input current which you can find on the rating plate. Installation of cables according to UL regulations is presented in Chapter 6.1.3.

Table 6-1 shows the minimum dimensions of the Cu-cables and the corresponding GG/GL fuse sizes. The dimensions of the fuses in the table have been given taking their function as a cable overload protection into account.

If the motor temperature protection of the drive (see the Application Manual) is used as an overload protection, the cable shall be chosen accordingly.

These instructions apply only to cases with one motor and one cable connection from the frequency converter to the motor. In any other case, ask the factory for more information.

<u>Mains cable</u>	Power cable intended for fixed installation and the specific mains voltage. Shielded cable not required. (NKCABLES/MCMK or similar recommended)
<u>Motor cable</u>	Power cable equipped with concentric protection wire and intended for the specific mains voltage. (NKCABLES /MCMK or similar recommended). OR: If EN61800-3 1 st environment is required, a cable with low-impedance shield.
<u>Control cable</u>	Screened cable equipped with compact low-impedance shield (NKCABLES /jamak, SAB/ÖZCuY-O or similar).

6.1.1.1 Cable and fuse sizes

Frame	Type	I _L [A]	Fuse [A]	Mains cable Cu [mm ²]	Terminal cable size (max)	
					Main terminal [mm ²]	Earth terminal [mm ²]
MF2	0007—0010	2-6	10	3*1.5+1.5	0.004	0.004
MF3	0015—0030	1-5	10	3*1.5+1.5	0.004	0.004
MF4	0015—0050	7—9	10	3*1.5+1.5	0.002—0.006	0.002—0.004
MF4	0075	12	16	3*2.5+2.5	0.002—0.006	0.002—0.004
MF5	0100	16	20	3*4+4	0.002—0.02	0.002—0.02
MF5	0150	22	25	3*6+6	0.002—0.02	0.002—0.02
MF5	0200	31	35	3*10+10	0.002—0.02	0.002—0.02

Table 6-1. Cable and fuse sizes for NXL

Automation and Control Solutions

Honeywell
1985 Douglas Drive North
Golden Valley, MIN 55422

Honeywell Limited-Honeywell Limitée
35 Dynamic Drive
Scarborough, Ontario
M1V 4Z9

63-2599

www.honeywell.com

6.1.2 Installation instructions

1	Before starting the installation, check that none of the components of the frequency converter is live.						
2	The frequency converter shall be installed inside a switchgear, separate cubicle or electrical room because of the protection class IP20 and the fact that the cable terminals are not protected.						
3	<p>Place the motor cables sufficiently far from other cables:</p> <ul style="list-style-type: none"> ▪ Avoid placing the motor cables in long parallel lines with other cables ▪ If the motor cables runs in parallel with other cables, note the minimum distances between the motor cables and other cables given in table below. ▪ The given distances also apply between the motor cables and signal cables of other systems. ▪ The maximum length (level H) of the motor cables is 30 m (drives with output power greater than 1.5kW) or 10 m (0.75...1.5kW). ▪ The motor cables should cross other cables at an angle of 90 degrees. <table style="margin-left: auto; margin-right: auto;"> <thead> <tr> <th style="text-align: center;">Distance between cables (m)</th> <th style="text-align: center;">Shielded cable (m)</th> </tr> </thead> <tbody> <tr> <td style="text-align: center;">0.3</td> <td style="text-align: center;">≤20</td> </tr> <tr> <td style="text-align: center;">1.0</td> <td style="text-align: center;"><50</td> </tr> </tbody> </table>	Distance between cables (m)	Shielded cable (m)	0.3	≤20	1.0	<50
Distance between cables (m)	Shielded cable (m)						
0.3	≤20						
1.0	<50						
4	If cable insulation checks are needed, see Chapter 6.1.4.						
5	<p>Connect the cables:</p> <ul style="list-style-type: none"> ▪ Strip the motor and mains cables as advised in Table 6-2 and Figure 6-4. ▪ Connect the mains, motor and control cables into their respective terminals (see e.g. Figure 6-6). ▪ For information on the installation of greater units, please contact the factory or your local distributor. ▪ For Information on cable installation according to UL regulations see Chapter 6.1.3. ▪ Make sure that the control cable wires do not come in contact with the electronic components of the unit. ▪ If an external brake resistor (option) is used, connect its cable to the appropriate terminal. ▪ Check the connection of the earth cable to the motor and the frequency converter terminals marked with . ▪ Connect the separate shield of the power cable to the earth plate of the frequency converter, motor and the supply centre. ▪ Ensure that the control cables or the cables of the unit are not trapped between the frame and the protection plate. 						

6.1.2.1 Stripping lengths of motor and mains cables

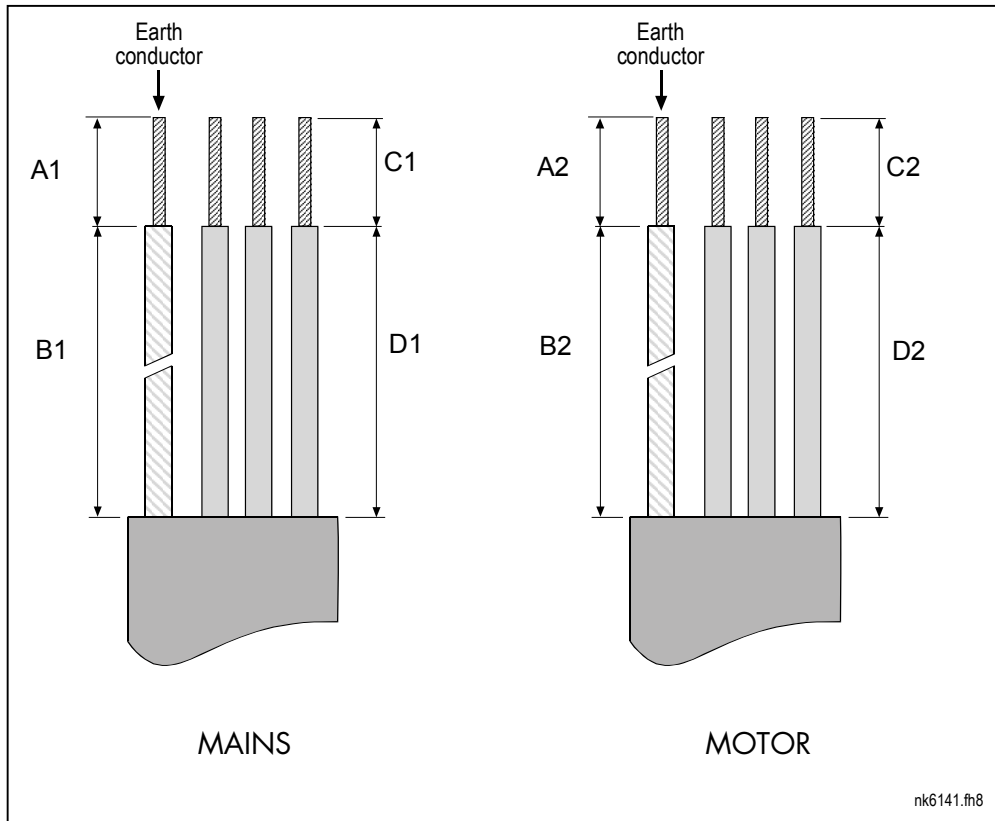

Figure 6-4. Stripping of cables

Frame	A1	B1	C1	D1	A2	B2	C2	D2
MF2	0.28	1.38	0.28	0.79	0.28	1.97	0.28	1.38
MF3	0.28	1.57	0.28	1.18	0.28	2.36	0.28	1.57
MF4	0.59	1.38	0.39	0.79	0.28	1.97	0.28	1.38
MF5	0.79	1.57	0.39	1.18	0.79	2.36	0.39	1.57

Table 6-2. Cables stripping lengths [inch]

6.1.2.2 Installation of cables to NXL

Note: In case you want to connect an external brake resistor (MF3 and bigger sizes), see separate Brake Resistor Manual. See also Chapter *Internal brake resistor connection* on page 63 in this manual.



Figure 6-5. NXL, MF2

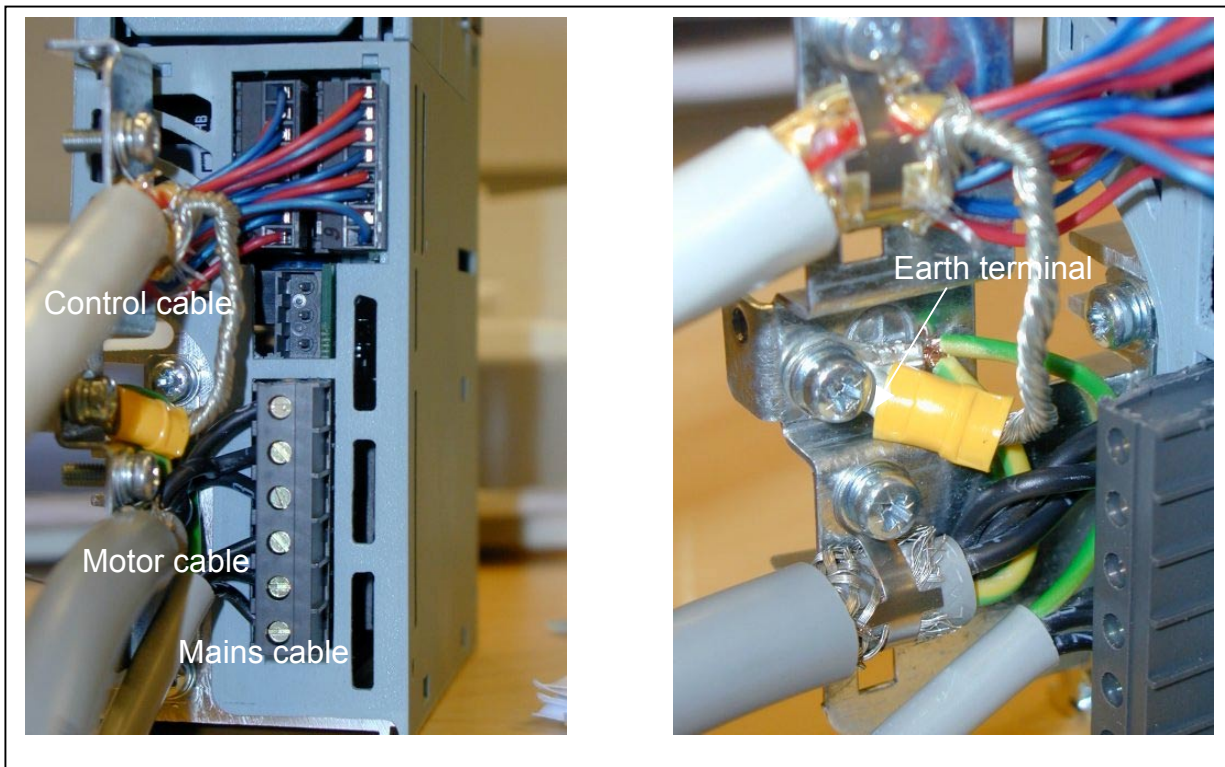

Figure 6-6. Cable installation in NXL, MF2



Figure 6-7. NXL, MF3

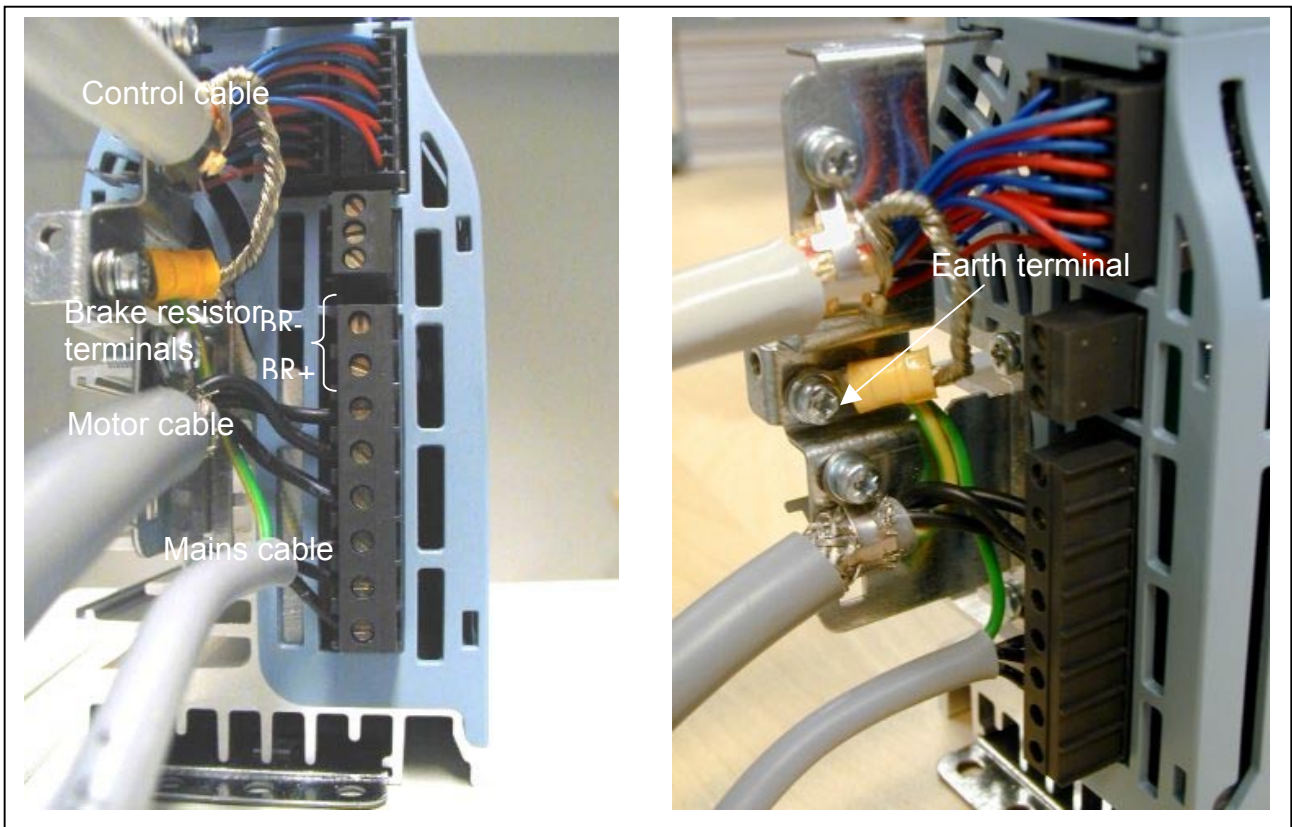

Figure 6-8. Cable installation in NXL, MF3



Figure 6-9. NXL, MF4

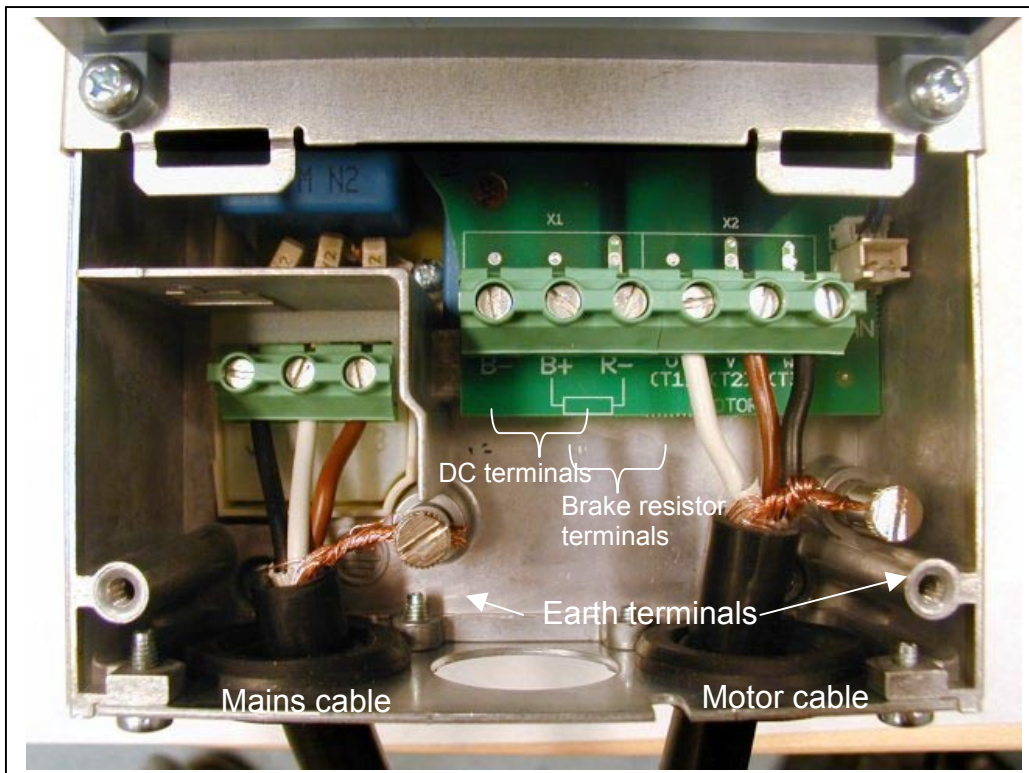

Figure 6-10. Cable installation in NXL, MF4



Figure 6-11. NXL, MF5

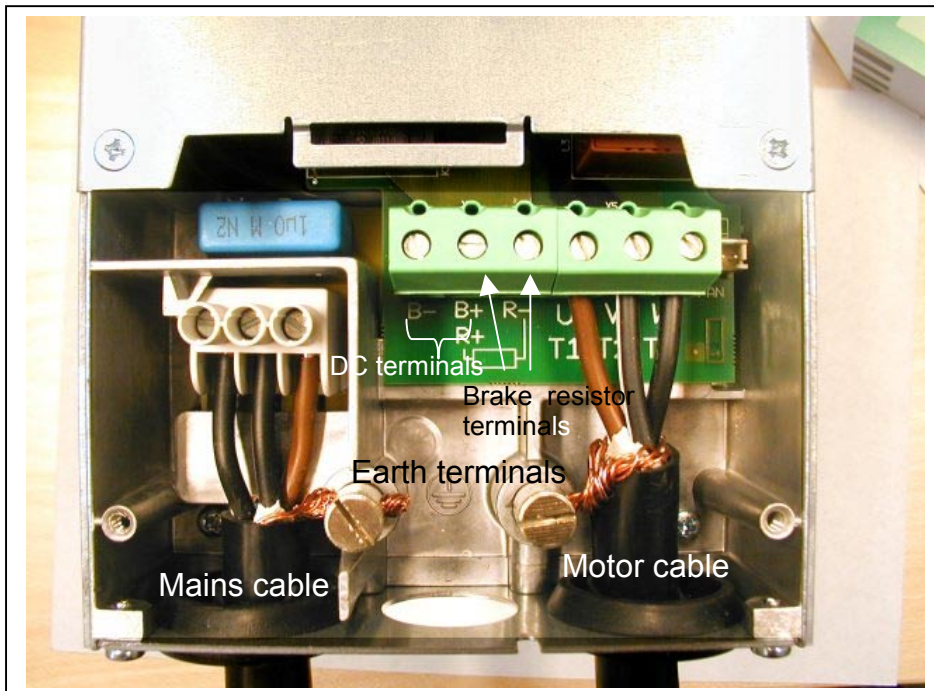

Figure 6-12. Cable installation in NXL, MF5

6.1.3 Cable installation and the UL standards

To meet the UL (Underwriters Laboratories) regulations, a UL-approved copper cable with a minimum heat-resistance of +60/75°C must be used.

The tightening torques of the terminals are given in Table 6-3.

Type	Frame	Tightening torque [Nm]	Tightening torque in-lbs.
NXL2 0002—0006	MF2	0.5—0.6	4—5
NXL5 0001—0005	MF3	0.5—0.6	4—5
NXL5 0007—0012	MF4	0.5—0.6	4—5
NXL5 0016—0032	MF5	1.2—1.5	10—13

Table 6-3. Tightening torques of terminals

6.1.4 Cable and motor insulation checks

1. Motor cable insulation checks

Disconnect the motor cable from terminals U, V and W of the frequency converter and from the motor. Measure the insulation resistance of the motor cable between each phase conductor as well as between each phase conductor and the protective ground conductor.

The insulation resistance must be $>1M\Omega$.

2. Mains cable insulation checks

Disconnect the mains cable from terminals L1, L2 and L3 of the frequency converter and from the mains. Measure the insulation resistance of the mains cable between each phase conductor as well as between each phase conductor and the protective ground conductor.

The insulation resistance must be $>1M\Omega$.

3. Motor insulation checks

Disconnect the motor cable from the motor and open the bridging connections in the motor connection box. Measure the insulation resistance of each motor winding. The measurement voltage must equal at least the motor nominal voltage but not exceed 1000 V. The insulation resistance must be $>1M\Omega$.

6.2 Control unit

The control unit of the NXL frequency converter is integrated with the power unit and consists roughly of the control board and one optional board, which can be connected to the *slot connector* of the control board.

The frequency converter is delivered from the factory with the basic configuration without an option board.

6.2.1 Control connections

The basic control connections are shown in Chapter 6.2.2.1.

The signal descriptions of the Multicontrol Application are presented below and in Chapter 2 of the Application Manual.

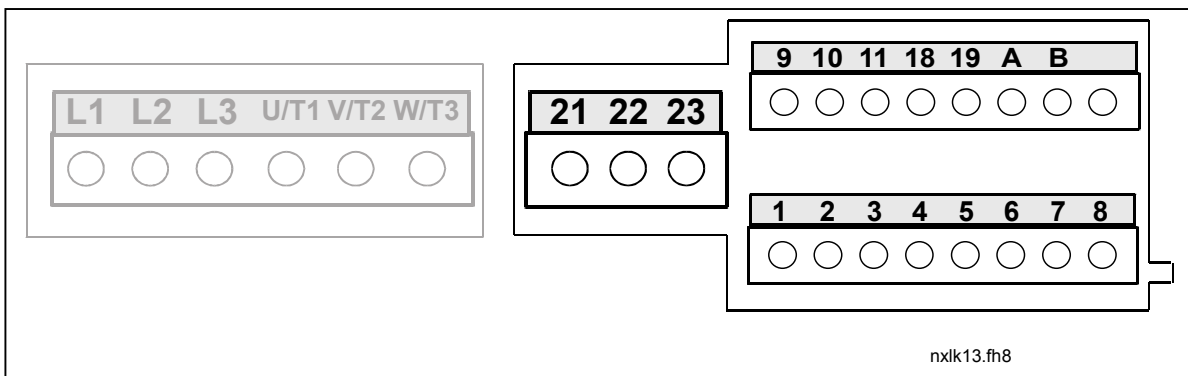

Figure 6-13. Control connections, MF2

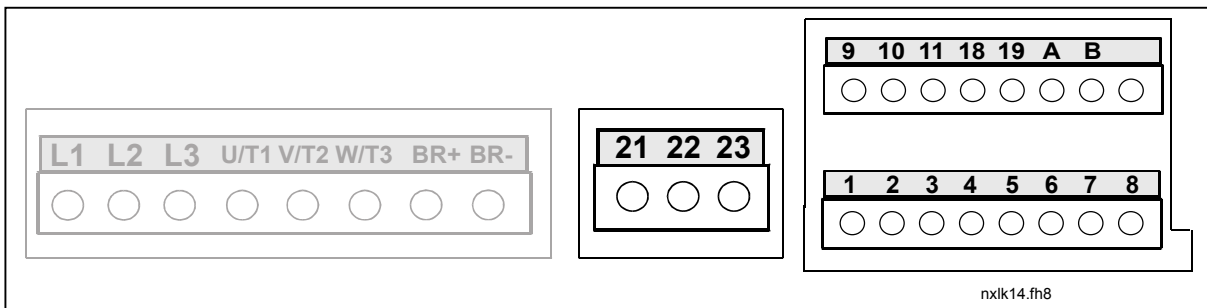

Figure 6-14. Control connections, MF3

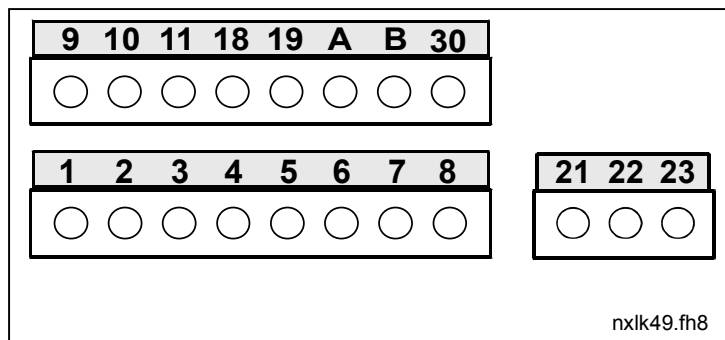

Figure 6-15. Control connections, MF4, MF5

Automation and Control Solutions

Honeywell
1985 Douglas Drive North
Golden Valley, MIN 55422

Honeywell Limited-Honeywell Limitée
35 Dynamic Drive
Scarborough, Ontario
M1V 4Z9

63-2599

www.honeywell.com

6.2.2 Control cables

The control cables shall be at least 0.5 mm² screened multicore cables, see chapter 6.1.1.1. The maximum terminal wire size is 2.5 mm² for the relay terminals and 1.5 mm² for other terminals.

6.2.2.1 Control I/O

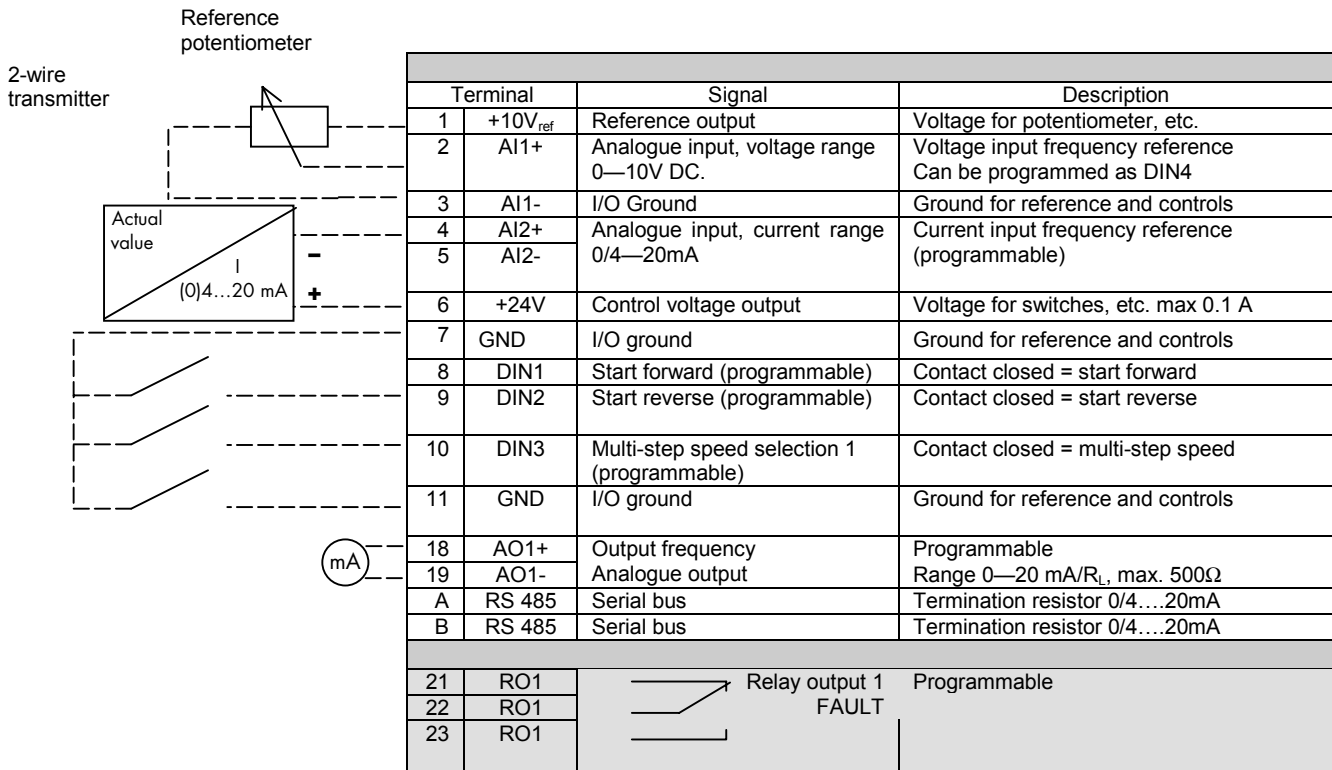

Table 6-4. Multicontrol application default I/O configuration (with 2-wire transmitter).

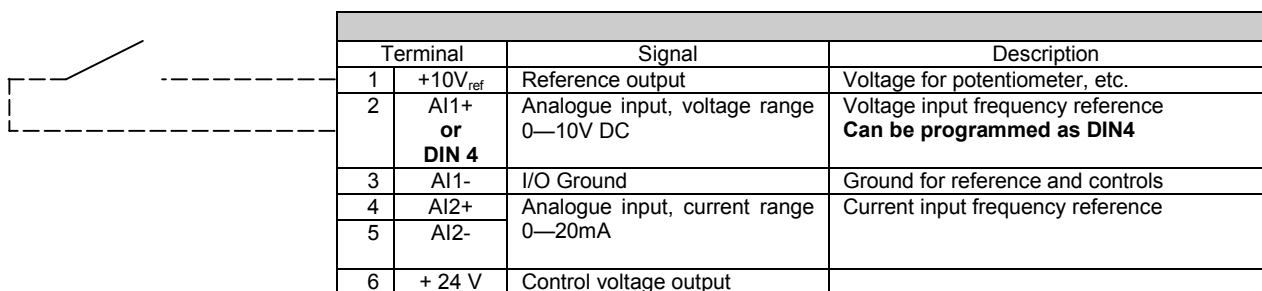

Table 6-5. The programming of AI1 as DIN4

6.2.3 Control terminal signals

Terminal	Signal	Technical information
1	+10 Vref	Reference voltage Maximum current 10 mA
2	AI1+	Analogue input, voltage (MF4 and bigger: voltage or current) Selection V or mA with jumper block X4 (see page 38): Default: 0– +10V (Ri = 200 kΩ) 0– 20mA (Ri = 250 Ω)
3	AI1–	Analogue input common Differential input if not connected to ground; Allows ±20V differential mode voltage to GND
4	AI2+	Analogue input, voltage or current Default: 0– 20mA (Ri = 250 Ω)
5	AI2–	Analogue input common Differential input; Allows ±20V differential mode voltage to GND
6	24 Vout	24V auxiliary voltage ±10%, maximum current 100 mA
7	GND	I/O ground Ground for reference and controls
8	DIN1	Digital input 1 Ri = min. 5kΩ
9	DIN2	Digital input 2
10	DIN3	Digital input 3
11	GND	I/O ground Ground for reference and controls
18	AO1+	Analogue signal (+output) Output signal range: Current 0(4)–20mA, RL max 500Ω or Voltage 0–10V, RL >1kΩ
19	AO1–	Analogue output common
A	RS 485	Serial bus
B	RS 485	Serial bus
21	RO1/1	 Relay output 1 Switching capacity: 24VDC/8A 250VAC/8A 125VDC/0,4A Relay output terminals are galvanically isolated from the I/O ground
22	RO1/2	
23	RO1/3	

Table 6-6. Control I/O terminal signals

6.2.3.1 Jumper selections on NXL basic board

The user is able to customise the functions of the frequency converter to better suit his needs by selecting certain positions for the jumpers on the NXL board. The positions of the jumpers determine the signal type of analogue input (terminal #2) and whether the termination resistor RS485 is used or not.

On the MF2 board, there is one jumper block X4 containing ten pins and two jumpers. On the MF3 board there are two jumper blocks: X4 containing six pins and three jumpers and X7 containing four pins and one jumper. The selectable positions of the jumpers are shown in the figure below. See also Figure 6-18 on the next page.

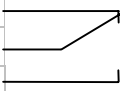
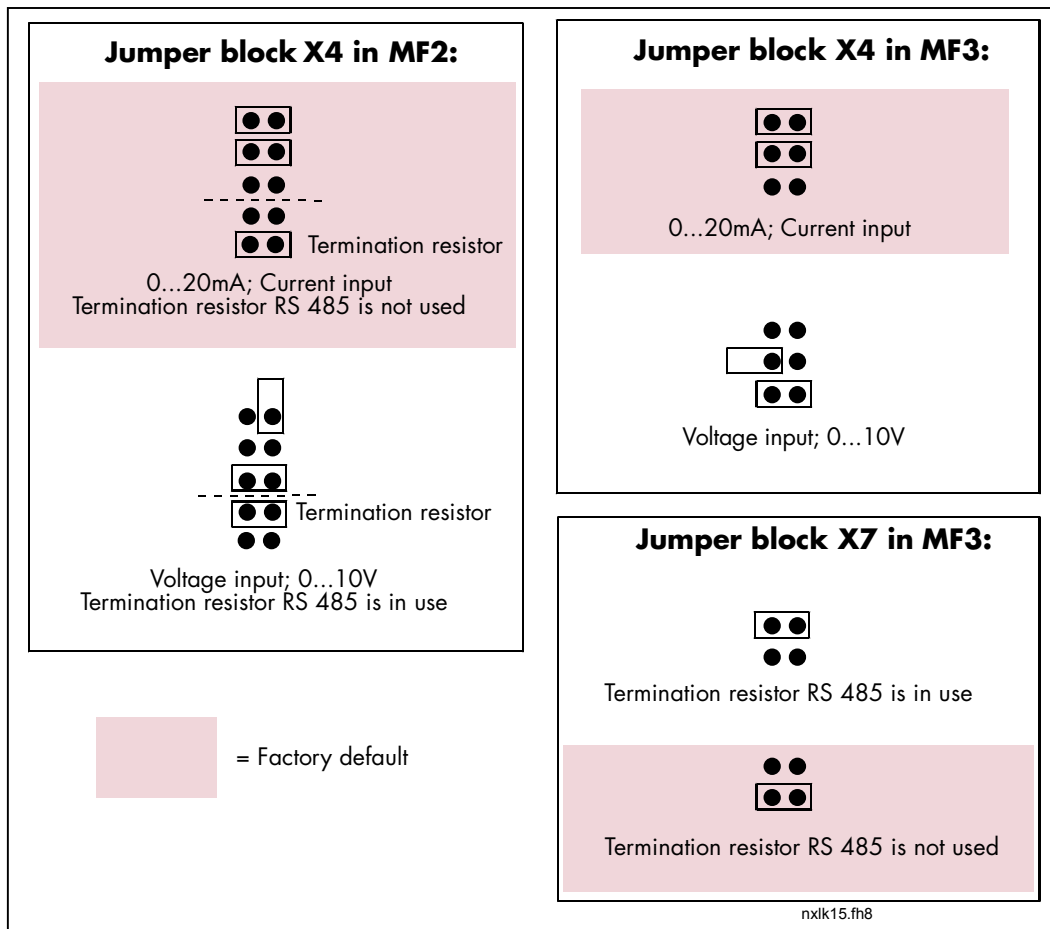

Figure 6-16. Jumper selection for NXL, MF2 and MF3

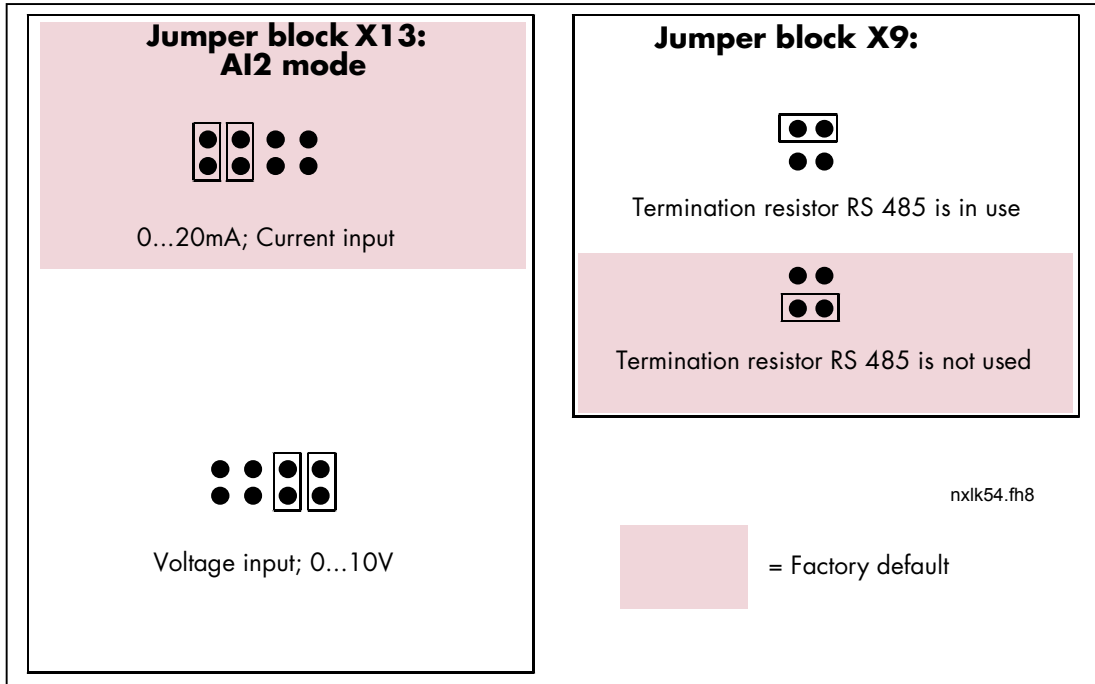



Figure 6-17. Jumper selection for NXL, MF4 and MF5

 WARNING	<p>Check the correct positions of the jumpers. Running the motor with signal settings different from the jumper positions will not harm the frequency converter but may damage the motor.</p>
 NOTE	<p>If you change the AI signal content also remember to change the corresponding parameter S6.9 in System Menu.</p>

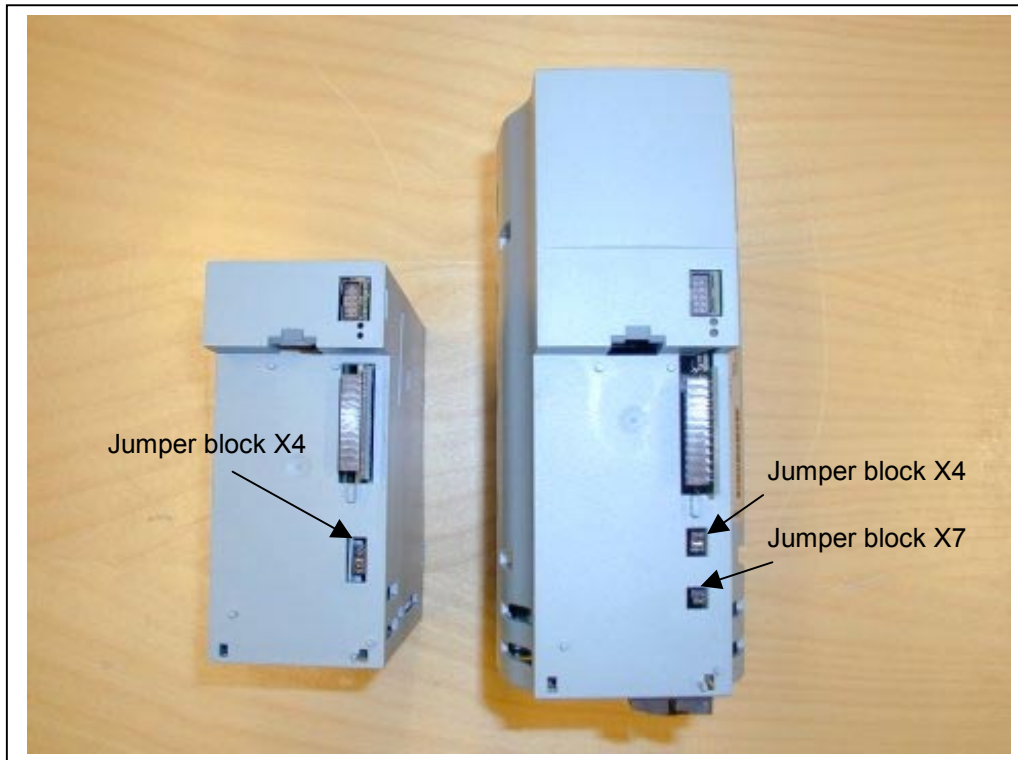

Figure 6-18. The location of jumper blocks in MF2 (left) and MF3 (right)

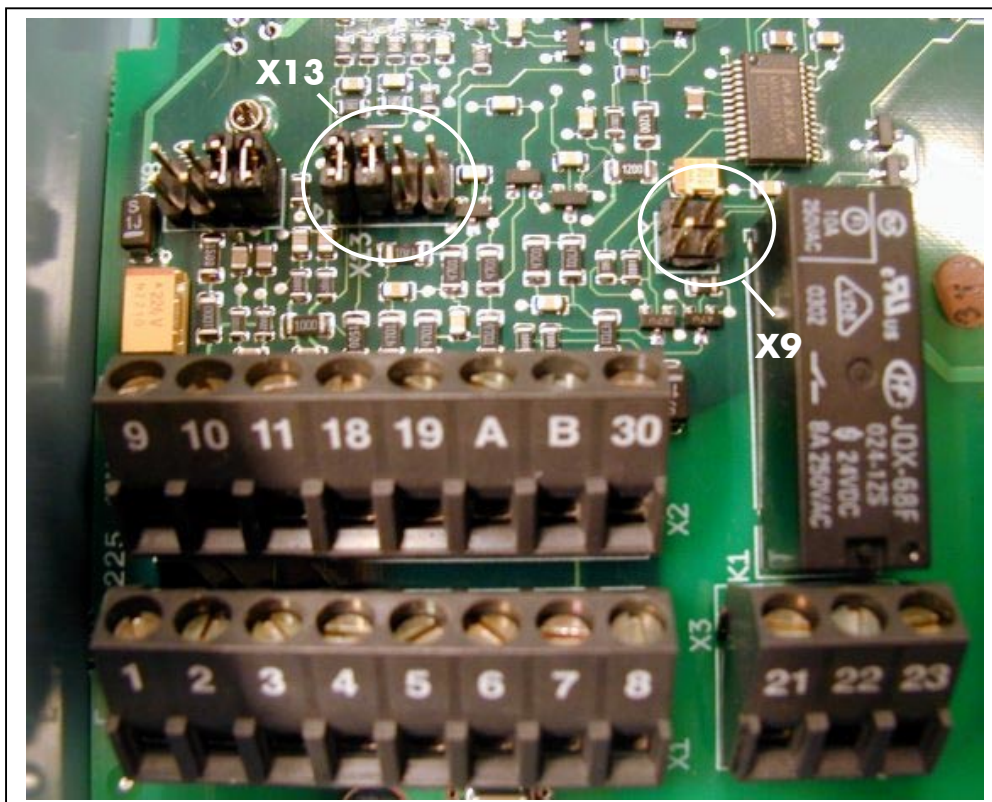



Figure 6-19. The location of jumper blocks in the control board of MF4 and MF5

7. CONTROL KEYPAD

The control keypad is the link between the NXL frequency converter and the user. The NXL control keypad features a seven-segment display with seven indicators for the Run status (RUN, , , READY, STOP, ALARM, FAULT) and three indicators for the control place (I/O term/ Keypad/BusComm).

The control information, i.e. the number of menu, the displayed value and the numeric information are presented with numeric symbols.

The frequency converter is operable through the seven push-buttons of the control keypad. Furthermore, the buttons serve the purposes of parameter setting and value monitoring.

The keypad is detachable and isolated from the input line potential.

7.1 Indications on the Keypad display

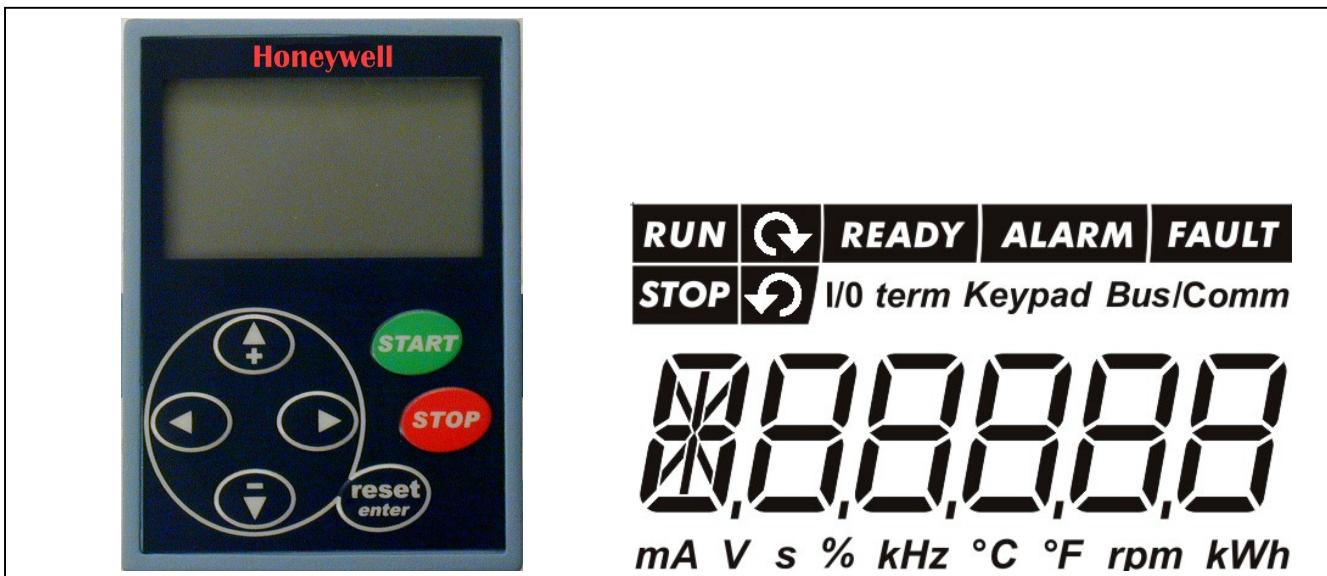



Figure 7-1. NXL control keypad and drive status indications

7.1.1 Drive status indications

The drive status indications tell the user what the status of the motor and the drive is and whether the motor control software has detected irregularities in motor or frequency converter functions.

- 1 RUN = Motor is running; Blinks when the stop command has been given but the frequency is still ramping down.
- 2   = Indicates the direction of motor rotation.
- 3 STOP = Indicates that the drive is not running.

Automation and Control Solutions

Honeywell
1985 Douglas Drive North
Golden Valley, MIN 55422

Honeywell Limited-Honeywell Limitée
35 Dynamic Drive
Scarborough, Ontario
M1V 4Z9

63-2599

www.honeywell.com

- 4 READY = Lights when AC power is on. In case of a fault, the symbol will not light up.
- 5 ALARM = Indicates that the drive is running outside a certain limit and a warning is given.
- 6 FAULT = Indicates that unsafe operating conditions were encountered due to which the drive was stopped.

7.1.2 Control place indications

The symbols *I/O term*, *Keypad* and *Bus/Comm* (see chapter 7.3.3.1) indicate the choice of control place made in the Keypad control menu (see chapter 7.3.3).

- a *I/O term* = I/O terminals are the selected control place; i.e. START/STOP commands or reference values etc. are given through the I/O terminals.
- b *Keypad* = Control keypad is the selected control place; i.e. the motor can be started or stopped, or its reference values etc. altered from the keypad.
- c *Bus/Comm* = The frequency converter is controlled through a fieldbus.

7.1.3 Numeric indications

The numeric indications provide the user with information on his present location in the keypad menu structure as well as with information related to the operation of the drive.

7.2 Keypad push-buttons

The NXL seven-segment control keypad features 7 push-buttons that are used for the control of the frequency converter (and motor), parameter setting and value monitoring.

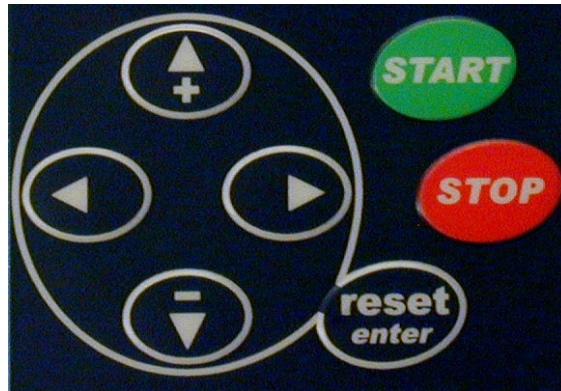



Figure 7-2. Keypad push-buttons

7.2.1 Button descriptions

- | | | |
|---|---|--|
|  | = | There are two operations integrated in this button. The button operates mainly as reset button except in the parameter edit mode. The button operation is shortly described below. |
| reset | = | This button is used to reset active faults. |
| enter | = | The Enter button serves for:
1) confirmation of selections
2) fault history reset (2...3 seconds) |
| ▲
+ | = | Browser button up
Browse the main menu and the pages of different submenus.
Edit values. |
| ▼
- | = | Browser button down
Browse the main menu and the pages of different submenus.
Edit values. |

- ◀ = Menu button left
Move backward in menu.
Move cursor left (in parameter edit mode).
Exit edit mode.
Hold down for 2...3 seconds to return to main menu.
- ▶ = Menu button right
Move forward in menu.
Move cursor right (in parameter edit mode).
Enter edit mode.
- = Start button.
Pressing this button starts the motor if the keypad is the active control place. See Chapter 7.3.3.1.
- start = Stop button.
Pressing this button stops the motor (unless disabled by parameter R3.4/R3.6).
- stop

7.3 Navigation on the control keypad

The data on the control keypad are arranged in menus and submenus. The menus are used for example for the display and editing of measurement and control signals, parameter settings (chapter 7.3.2), reference values and fault displays (chapter 7.3.4).

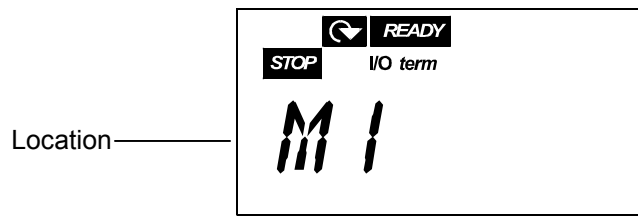

The first menu level consists of menus M1 to E7 and is called the *Main menu*. The user can navigate in the main menu using the *Browser buttons* up and down. The desired submenu can be entered from the main menu using the *Menu buttons*. When there still are pages to enter under the currently displayed menu or page, the last digit of the figure on the display is blinking and by pressing the *Menu button right*, you can reach the next menu level.

The control keypad navigation chart is shown on page 46. Please note that the menu **M1** is located in the lower left corner. From there you will be able to navigate your way up to the desired menu using the menu and browser buttons.

More detailed descriptions of the menus you will find later in this Chapter.

NOTE!

By default the System Menu (**S6**) and Expander Board Menu (**E7**) are hidden. In order to browse these menus you have to set the value of **parameter 2.1.22** (Parameter conceal) to **0**:

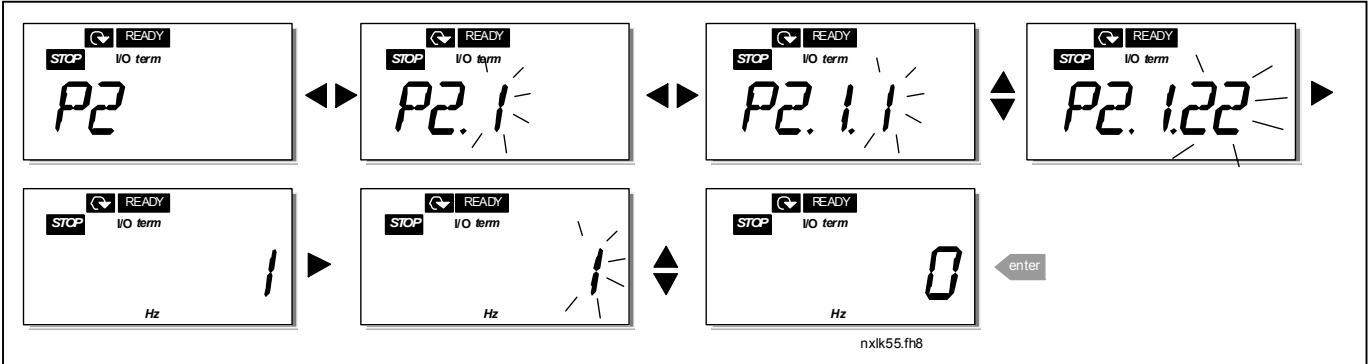

Figure 7-3. Changing the value of parameter 2.1.22

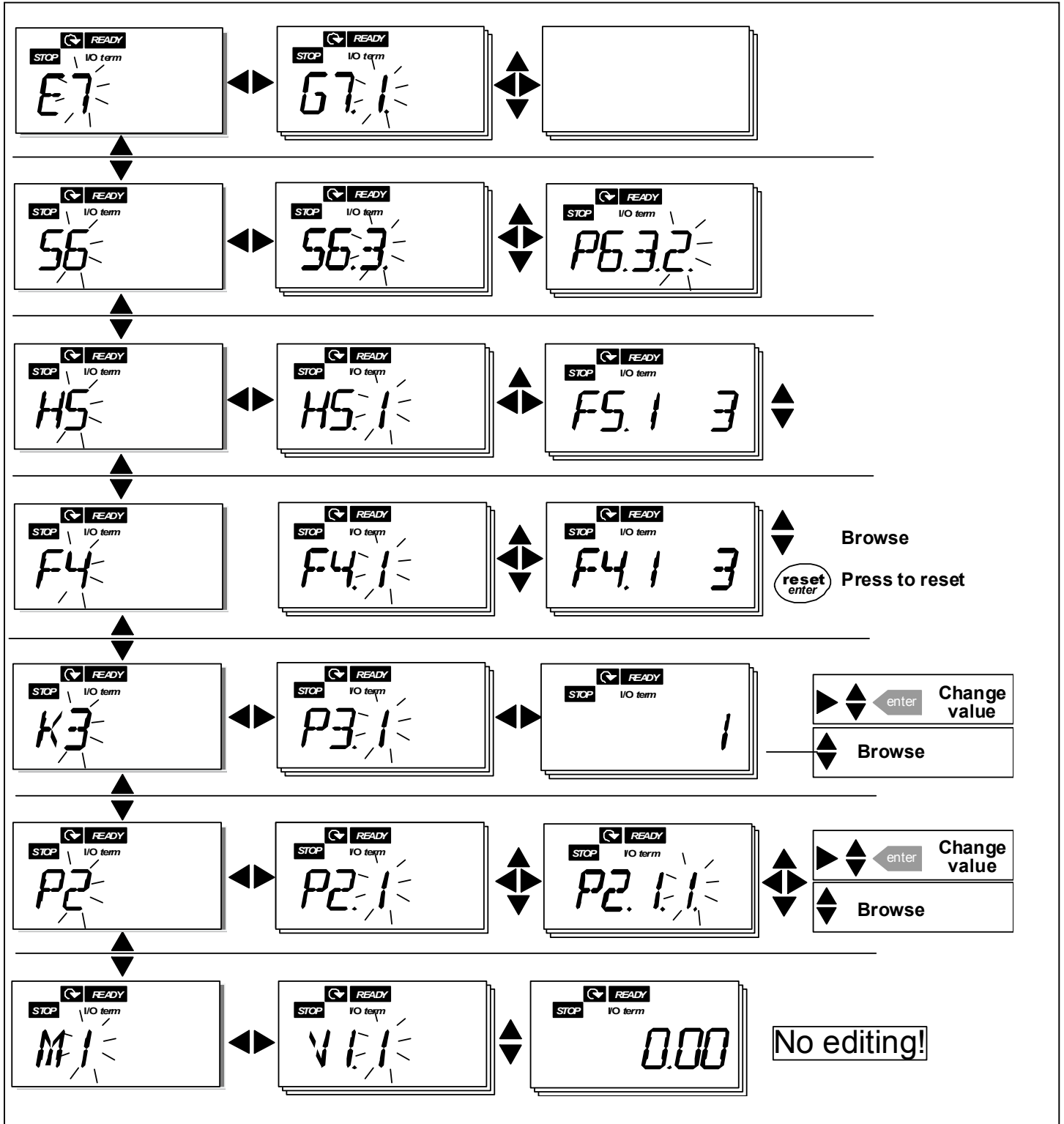

Figure 7-4. Keypad navigation chart

Menu functions

Code	Menu	Min	Max	Selections
M1	Monitoring menu	V1.1	V1.23	See chapter 7.3.1 for the monitoring values
P2	Parameter menu	P2.1	P2.9	P2.1 = Basic parameters P2.2 = Input signals P2.3 = Output signals P2.4 = Drive control P2.5 = Prohibit frequencies P2.6 = Motor control P2.7 = Protections P2.8 = Autorestart P2.9 = PID control P2.10 = Pump and fan control See the Multi-control application manual for detailed parameter lists
K3	Keypad control menu	P3.1	R3.6	P3.1 = Selection of control place R3.2 = Keypad reference P3.3 = Keypad direction P3.4 = Stop button activation R3.5 = PID reference 1 R3.6 = PID reference 2
F4	Active faults menu			Shows the active faults and their types
H5	Fault history menu			Shows the fault history list
S6	System menu	S6.3	S6.10	S6.3 = Copy parameters S6.5 = Security S6.6 = Keypad settings S6.7 = Hardware settings S6.8 = System info S6.9 = AI mode S6.10 = Fieldbus parameters Parameters are described in chapter 7.3.6
E7	Expander board menu			

Table 7-1. Main menu functions

Automation and Control Solutions

Honeywell
1985 Douglas Drive North
Golden Valley, MIN 55422

Honeywell Limited-Honeywell Limitée
35 Dynamic Drive
Scarborough, Ontario
M1V 4Z9

63-2599

www.honeywell.com

7.3.1 Monitoring menu (M1)

You can enter the Monitoring menu from the Main menu by pushing the *Menu button right* when the location indication **M1** is visible on the display. How to browse through the monitored values is presented in Figure 7-5.

The monitored signals carry the indication **V#.#** and they are listed in Table 7-2. The values are updated once every 0.3 seconds.

This menu is meant only for signal checking. The values cannot be altered here. For changing values of parameters see Chapter 7.3.2.

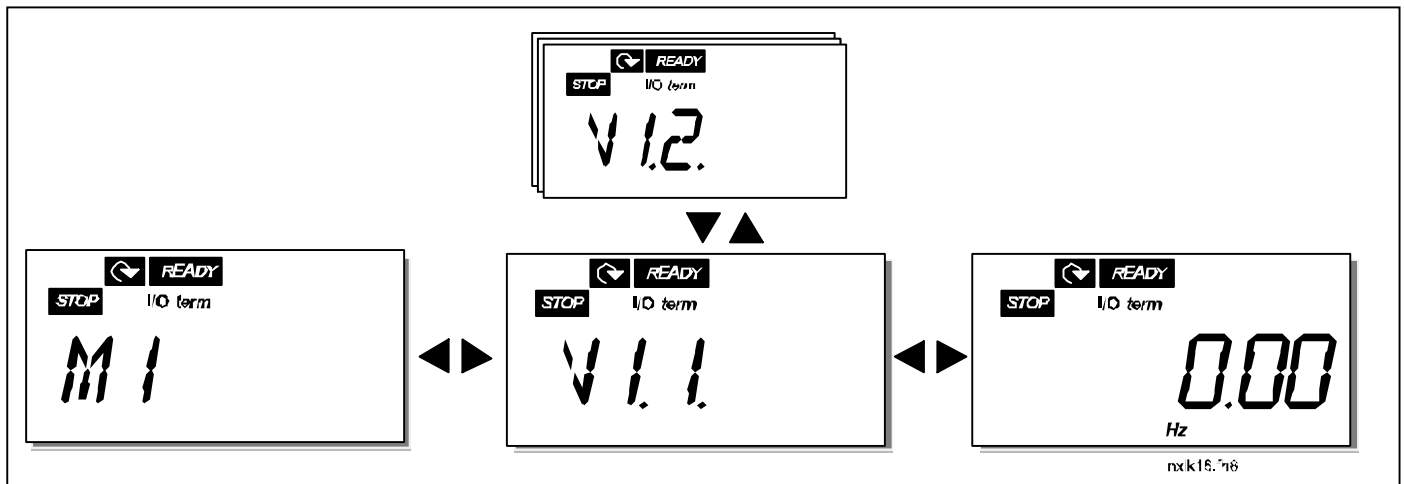

Figure 7-5. Monitoring menu

Code	Signal name	Unit	Description
V1.1	Output frequency	Hz	Frequency to the motor
V1.2	Frequency reference	Hz	
V1.3	Motor speed	rpm	Calculated motor speed
V1.4	Motor current	A	Measured motor current
V1.5	Motor torque	%	Calculated actual torque/nominal torque of the unit
V1.6	Motor power	%	Calculated actual power/nominal power of the unit
V1.7	Motor voltage	V	Calculated motor voltage
V1.8	DC-link voltage	V	Measured DC-link voltage
V1.9	Unit temperature	°C	Heat sink temperature
V1.10	Analogue input 1	V	AI1
V1.11	Analogue input 2	mA	AI2
V1.12	Analogue output current	mA	AO1
V1.13	Analogue output current 1, expander board	mA	
V1.14	Analogue output current 2, expander board	mA	
V1.15	DIN1, DIN2, DIN3		Digital input statuses
V1.16	DIE1, DIE2, DIE3		I/O expander board: Digital input statuses
V1.17	RO1		Relay output 1 status
V1.18	ROE1, ROE2, ROE3		I/O exp. board: Relay output statuses
V1.19	DOE 1		I/O exp. board: Digital output 1 status
V1.20	PID Reference	%	In percent of the maximum process reference
V1.21	PID Actual value	%	In percent of the maximum actual value
V1.22	PID Error value	%	In percent of the maximum error value
V1.23	PID Output	%	In percent of the maximum output value

Table 7-2. Monitored signals

Automation and Control Solutions

Honeywell
1985 Douglas Drive North
Golden Valley, MIN 55422

Honeywell Limited-Honeywell Limitée
35 Dynamic Drive
Scarborough, Ontario
M1V 4Z9

63-2599

www.honeywell.com

7.3.2 Parameter menu (P2)

Parameters are the way of conveying the commands of the user to the frequency converter. The parameter values can be edited by entering the *Parameter Menu* from the *Main Menu* when the location indication **P2** is visible on the display. The value editing procedure is presented in Figure 7-6.

Push the *Menu button right* once to move into the *Parameter Group Menu (G#)*. Locate the parameter group desired by using the *Browser buttons* and push the *Menu button right* again to enter the group and its parameters. Use again the *Browser buttons* to find the parameter (*P#*) you want to edit. From here you can proceed in two different ways: Pushing the *Menu button right* takes you to the edit mode. As a sign of this, the parameter value starts to blink. You can now change the value in two different manners:

- 1 Just set the new desired value with the *Browser buttons* and confirm the change with the *Enter button*. Consequently, the blinking stops and the new value is visible in the value field.
- 2 Push the *Menu button right* once again. Now you will be able to edit the value digit by digit. This editing manner may come in handy, when a relatively greater or smaller value than that on the display is desired. Confirm the change with the *Enter button*.

The value will not change unless the Enter button is pushed. Pressing the *Menu button left* takes you back to the previous menu.

Several parameters are locked, i.e. uneditable, when the drive is in RUN status. The frequency converter must be stopped in order to edit these parameters.

The parameters values can also be locked using the function in menu **S6** (see Chapter Parameter lock (P6.5.2)).

You can return to the *Main menu* anytime by pressing the *Menu button left* for 1—2 seconds.

The Multi-Control Application includes several sets of parameters. You will find the parameter lists in the Application Section of this manual.

Once in the last parameter of a parameter group, you can move directly to the first parameter of that group by pushing the *Browser button up*.

See the diagram for parameter value change procedure on page 51.

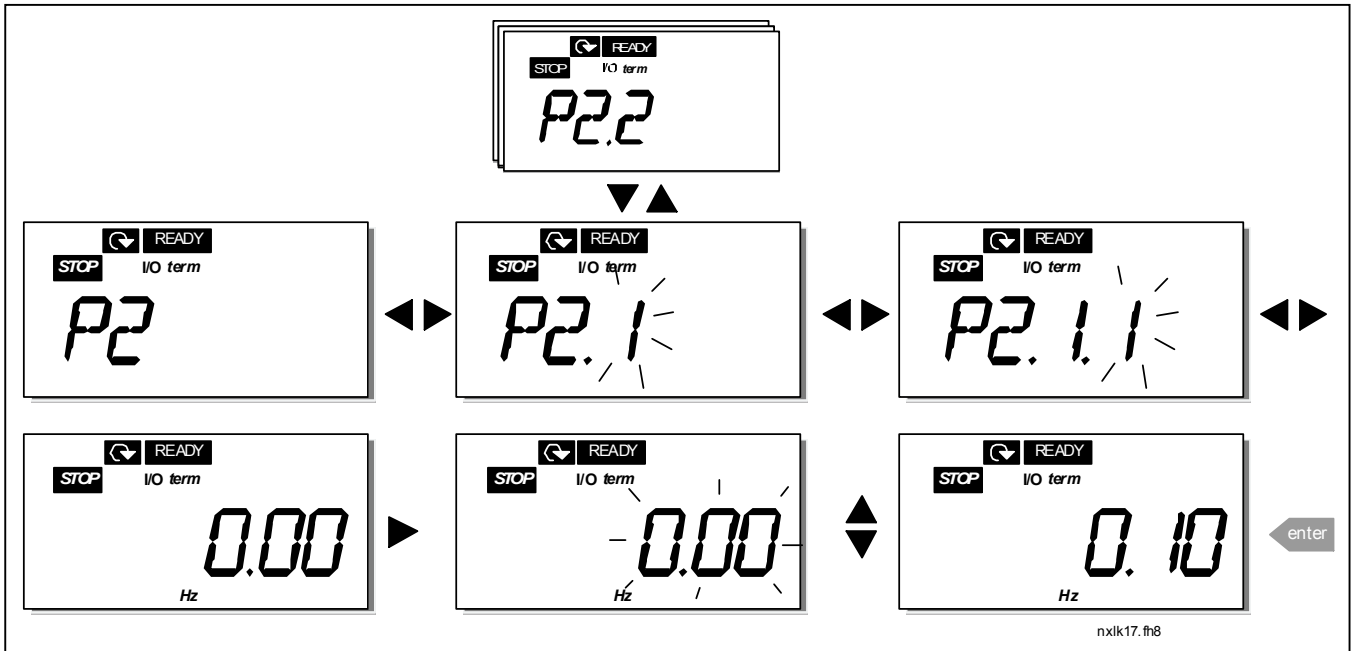

Figure 7-6. Parameter value change procedure

7.3.3 Keypad control menu (K3)

In the *Keypad Controls Menu*, you can choose the control place, edit the frequency reference and change the direction of the motor. Enter the submenu level with the *Menu button right*.

Parameters in Menu K3	Selections
P3.1 = Selection of control place	1 = I/O terminals 2 = Keypad 3 = Fieldbus
R3.2 = Keypad reference	
P3.3 = Keypad direction	0 = Forward 1 = Reverse
P3.4 = Stop button activation	0 = Limited function of Stop button 1 = Stop button always enabled
R3.5 = PID reference 1	
R3.6 = PID reference 2	

7.3.3.1 Selection of control place

There are three different places (sources) which the frequency converter can be controlled from. For each control place, a different symbol will appear on the alphanumeric display:

Control place	Symbol
I/O terminals	<i>I/O term</i>
Keypad (panel)	<i>Keypad</i>
Fieldbus	<i>Bus/Comm</i>

Change the control place by entering the edit mode with the *Menu button right*. The options can then be browsed through with the *Browser buttons*. Select the desired control place with the *Enter button*. See the diagram below. See also 0 above.

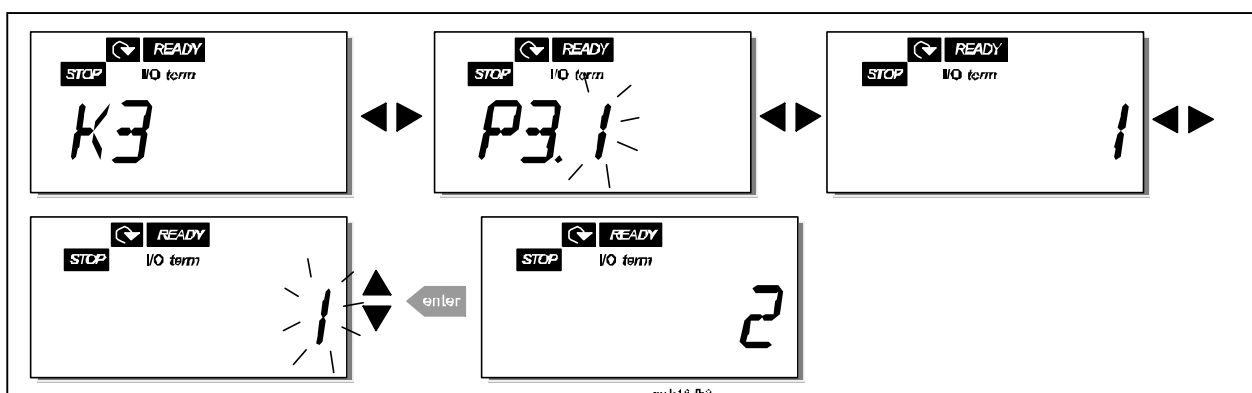

Figure 7-7. Selection of control place

Automation and Control Solutions

Honeywell
1985 Douglas Drive North
Golden Valley, MIN 55422

Honeywell Limited-Honeywell Limitée
35 Dynamic Drive
Scarborough, Ontario
M1V 4Z9

63-2599

www.honeywell.com

7.3.3.2 Keypad reference

The keypad reference submenu (**R3.2**) displays and allows the operator to edit the frequency reference. The changes will take place immediately. **This reference value will not, however, influence the rotation speed of the motor unless the keypad has been selected as the active control place.**

NOTE: The maximum difference between the output frequency and the keypad reference is 6 Hz. The application software monitors the keypad frequency automatically.
See also 0 above.

See Figure 7-6 for how to edit the reference value (pressing the *Enter button* is not, however, necessary).

7.3.3.3 Keypad direction

The keypad direction submenu displays and allows the operator to change the rotating direction of the motor. **This setting will not, however, influence the rotation direction of the motor unless the keypad has been selected as the active control place.**

See also 0 above.

See Figure 7-7 for how to change the rotation direction.

7.3.3.4 Stop button activation

By default, pushing the STOP button will **always** stop the motor regardless of the selected control place. You can disable this function by giving parameter 3.4 the value **0**. If the value of this parameter is **0**, the STOP button will stop the motor only **when the keypad has been selected as the active control place.**

See Figure 7-7 for how to change the value of this parameter.

7.3.4 Active faults menu (F4)

The *Active faults menu* can be entered from the *Main menu* by pushing the *Menu button right* when the location indication **F4** is visible on the keypad display.

The memory of active faults can store the maximum of 5 faults in the order of appearance. The display can be cleared with the *Reset button* and the read-out will return to the same state it was before the fault trip. The fault remains active until it is cleared with the *Reset button* or with a reset signal from the I/O terminal.

Note! Remove external Start signal before resetting the fault to prevent unintentional restart of the drive.

Normal state,
no faults:

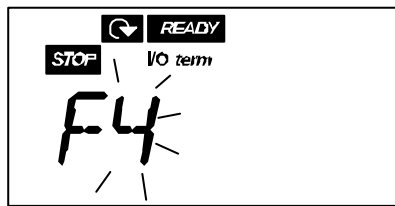

7.3.4.1 Fault types

In the NXL frequency converter, there are two different types of faults. These types differ from each other on the basis of the subsequent behaviour of the drive. See Table 7-3. Fault types.

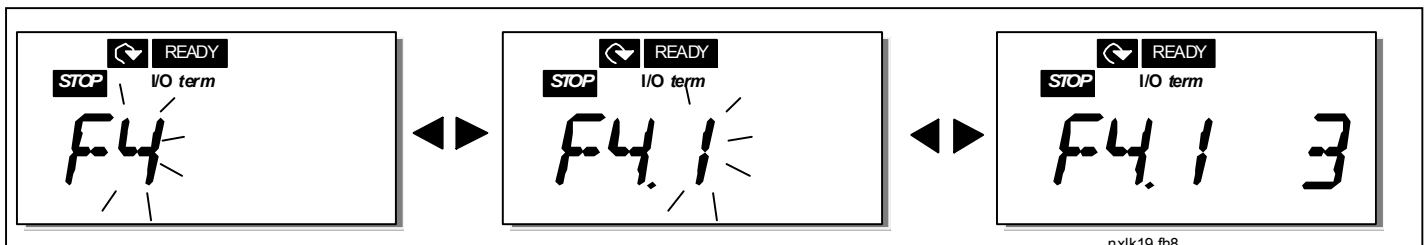

Figure 7-8. Fault display

Fault type symbol	Meaning
A (Alarm)	This type of fault is a sign of an unusual operating condition. It does not cause the drive to stop, nor does it require any special actions. The 'A fault' remains in the display for about 30 seconds.
F (Fault)	An 'F fault' is a kind of fault that makes the drive stop. Actions need to be taken in order to restart the drive.

Table 7-3. Fault types

7.3.4.2 Fault codes

The fault codes, their causes and correcting actions are presented in the table below. The shadowed faults are A faults only. The items written in white on black background present faults for which you can program different responses in the application. See parameter group Protections.

Note! When you contact the factory or the distributor due to a fault, it is advisable to write down all fault texts and codes that appear on the keypad

Fault code	Fault	Possible cause	Correcting measures
1	Overcurrent	Frequency converter has detected too high a current ($>4 \cdot I_n$) in the motor cable: <ul style="list-style-type: none"> – sudden heavy load increase – short circuit in motor cables – unsuitable motor 	Check loading. Check motor size. Check cables.
2	Overvoltage	The DC-link voltage has exceeded the limits defined in Table 4-3. <ul style="list-style-type: none"> – too short a deceleration time – high overvoltage spikes in supply 	Make the deceleration time longer.
3	Earth fault	Current measurement has detected that the sum of motor phase current is not zero. <ul style="list-style-type: none"> – insulation failure in cables or motor 	Check motor cables and motor.
5	Charging switch	The charging switch is open, when the START command has been given. <ul style="list-style-type: none"> – faulty operation – component failure 	Reset the fault and restart. Should the fault re-occur, contact the distributor near to you.
8	System fault	<ul style="list-style-type: none"> - component failure - faulty operation 	Reset the fault and restart. Should the fault re-occur, contact the distributor near to you.
9	Undervoltage	DC-link voltage is under the voltage limits defined in Table 4-3. <ul style="list-style-type: none"> – most probable cause: too low a supply voltage – frequency converter internal fault 	In case of temporary supply voltage break reset the fault and restart the frequency converter. Check the supply voltage. If it is adequate, an internal failure has occurred. Contact the distributor near to you.
11	Output phase supervision	Current measurement has detected that there is no current in one motor phase.	Check motor cable and motor.
13	Frequency converter under-temperature	Heatsink temperature is under -10°C	

14	Frequency converter overtemperature	Heatsink temperature is over 90°C. Overtemperature warning is issued when the heatsink temperature exceeds 85°C.	Check the correct amount and flow of cooling air. Check the heatsink for dust. Check the ambient temperature. Make sure that the switching frequency is not too high in relation to ambient temperature and motor load.
15	Motor stalled	Motor stall protection has tripped.	Check motor.
16	Motor overtemperature	Motor overheating has been detected by frequency converter motor temperature model. Motor is overloaded.	Decrease the motor load. If no motor overload exists, check the temperature model parameters.
17	Motor underload	Motor underload protection has tripped.	
22 23	EEPROM checksum fault	Parameter save fault – faulty operation – component failure	Contact the distributor near to you
24	Counter fault	Values displayed on counters are incorrect	
25	Microprocessor watchdog fault	– faulty operation – component failure	Reset the fault and restart. Should the fault re-occur, contact the distributor near to you.
26	Start-up prevented	Start-up of the drive has been prevented.	Cancel prevention of start-up.
29	Thermistor fault	The thermistor input of option board has detected increase of the motor temperature	Check motor cooling and loading Check thermistor connection (If thermistor input of the option board is not in use it has to be short circuited)
34	Internal bus communication	Ambient interference or defective hardware	Reset the fault and restart Should the fault re-occur, contact the distributor near to you.
37	Device change	Option board changed. Different power rating of drive.	Reset
38	Device added	Option board added. Drive of different power rating added.	Reset
39	Device removed	Option board removed. Drive removed.	Reset
40	Device unknown	Unknown option board or drive.	Contact the distributor near to you.
41	IGBT temperature	IGBT Inverter Bridge overtemperature protection has detected too high a short term overload current	Check loading. Check motor size.
42	Brake resistor overtemperature	Brake resistor overtemperature protection has detected too heavy braking	Set the deceleration time longer. Use external brake resistor.

44	Device change	Option board changed. Different power rating of drive.	Reset Note: No fault time data record! Note: Application parameter values restored to default.
45	Device added	Option board added. Drive of different power rating added.	Reset Note: No fault time data record! Note: Application parameter values restored to default.
50	Analogue input $I_{in} < 4\text{mA}$ (selected signal range 4 to 20 mA)	Current at the analogue input is $< 4\text{mA}$. – control cable is broken or loose – signal source has failed	Check the current loop circuitry.
51	External fault	Digital input fault.	
52	Keypad communication fault	The connection between the control keypad and the frequency converter is broken.	Check keypad connection and possible keypad cable.
53	Fieldbus fault	The data connection between the fieldbus Master and the fieldbus board is broken	Check installation. If installation is correct contact the nearest distributor
54	Slot fault	Defective option board or slot	Check board and slot. Contact the nearest distributor
55	Actual value supervision	Actual value has exceeded or fallen below (depending on par. 2.7.22) the actual value supervision limit (par. 2.7.23)	

Table 7-4. Fault codes

Automation and Control Solutions

Honeywell
1985 Douglas Drive North
Golden Valley, MIN 55422

Honeywell Limited-Honeywell Limitée
35 Dynamic Drive
Scarborough, Ontario
M1V 4Z9

63-2599

www.honeywell.com

7.3.5 Fault history menu (H5)

The *Fault history menu* can be entered from the *Main menu* by pushing the *Menu button right* when the location indication **H5** is visible on the keypad display.

All faults are stored in the *Fault history menu* in which you can browse through them using the *Browser buttons*. You can return to the previous menu anytime by pushing the *Menu button left*.

The memory of the frequency converter can store a maximum of 5 faults in the order of appearance. The latest fault carries the indication H5.1, the second latest H5.2 etc. If there are 5 uncleared faults in the memory the next occurring fault will erase the oldest from the memory.

Pressing the *Enter button* for about 2 to 3 seconds resets the whole fault history.

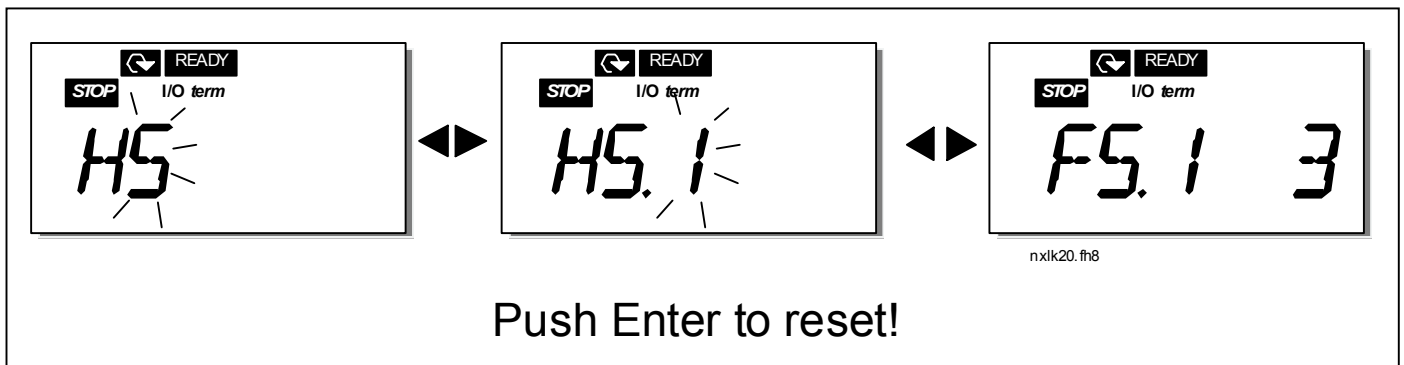

Figure 7-9. Fault history menu

7.3.6 System menu (S6)

The *System menu* can be entered from the main menu by pushing the *Menu button right* when the location indication **S6** is visible on the display.

The controls associated with the general use of the frequency converter, such as keypad settings, customised parameter sets or information about the hardware and software are located under the *System menu*.

Below you will find a list of the functions available in the System menu.

Functions in the System menu

Code	Function	Min	Max	Unit	Default	Cust	Selections
S6.3	Copy parameters						
P6.3.1	Parameter sets						0 = Select 1 = Store set 1 2 = Load set 1 3 = Store set 2 4 = Load set 2 5 = Load factory defaults 6 = Fault 7 = Wait 8 = OK
S6.5	Security						
P6.5.2	Parameter lock				0		0 = Change Enabled 1 = Change Disabled
S6.6	Keypad settings						
P6.6.1	Default page				1.1		
P6.6.3	Timeout time	5	65535	s	30		
S6.7	Hardware settings						
P6.7.1	Brake resistor connection				0		Note! External brake resistor is available only for sizes MF3 to MF6
P6.7.2	Fan control				0		0 = Continuous 1 = Temperature (only sizes MF4 and bigger)
P6.7.3	HMI acknowledg. timeout	200	5000	ms	200		
P6.7.4	HMI number of retries	1	10		5		
S6.8	System info						
S6.8.1	Counters menu						
C6.8.1.1	Mwh counter			KWh			
C6.8.1.2	Operating days counter			hh:mm:ss			
C6.8.1.3	Operating hours counter			hh:mm:ss			
S6.8.2	Trip counters						
T6.8.2.1	MWh trip counter			kWh			
P6.8.2.2	Clear MWh trip counter						
T6.8.2.3	Operating days trip counter						

T6.8.2.4	Operating hours trip counter			hh:mm:ss		
P6.8.2.5	Clear operating time counter					
S6.8.3	Software info					
I6.8.3.1	Software package					
I6.8.3.2	System SW version					
I6.8.3.3	Firmware interface					
I6.8.3.4	System load			%		
S6.8.4	Application info					
S6.8.4.1	Application					
A6.8.4.1.1	Application id					
A6.8.4.1.2	Application version					
A6.8.4.1.3	Firmware interface					
S6.8.5	Hardware info					
I6.8.5.2	Unit voltage			V		
I6.8.5.3	Brake chopper					
I6.8.5.4	Brake resistor					
S6.8.6	Options					
S6.8.6.1	NXOPT					
E6.8.6.1.1	Status					
E6.8.6.1.2	Program version					
S6.9	AI mode					
P6.9.2	AIA2 mode	0				
S6.10	Fieldbus parameters					
I6.10.1	Communication status					
P6.10.2	Fieldbus protocol	1	1		1	1=Modbus protocol
P6.10.3	Slave address	1	255		1	Addresses 1 – 255
P6.10.4	Baud rate	0	8		5	0=300 baud 1=600 baud 2=1200 baud 3=2400 baud 4=4800 baud 5=9600 baud 6=19200 baud 7=38400 baud 8=57600 baud
P6.10.5	Stop bits	0	1		0	0=1 1=2
P6.10.6	Parity type	0	2		0	0=None 1=Odd 2=Even
P6.10.7	Communication timeout	0	300	s	0	0=Not used 1=1 second 2=2 seconds, etc

Table 7-5. System menu functions

Automation and Control Solutions

Honeywell
1985 Douglas Drive North
Golden Valley, MIN 55422

Honeywell Limited-Honeywell Limitée
35 Dynamic Drive
Scarborough, Ontario
M1V 4Z9

63-2599

www.honeywell.com

7.3.6.1 Copy parameters

The Copy parameters submenu (**S6.3**) is located under the *System menu*.

The NXL frequency converter features a possibility for the user to store and load two customised parameter sets (all parameters included in the application) and to load back the factory default parameter values.

Parameter sets (S6.3.1)

On *Parameter sets* page (**S6.3.1**), push the *Menu button right* to enter the *Edit menu*. You can store or load two customised parameter sets or load back the factory defaults. Confirm with the *Enter button*. Wait, until **8 (=OK)** appears on the display.

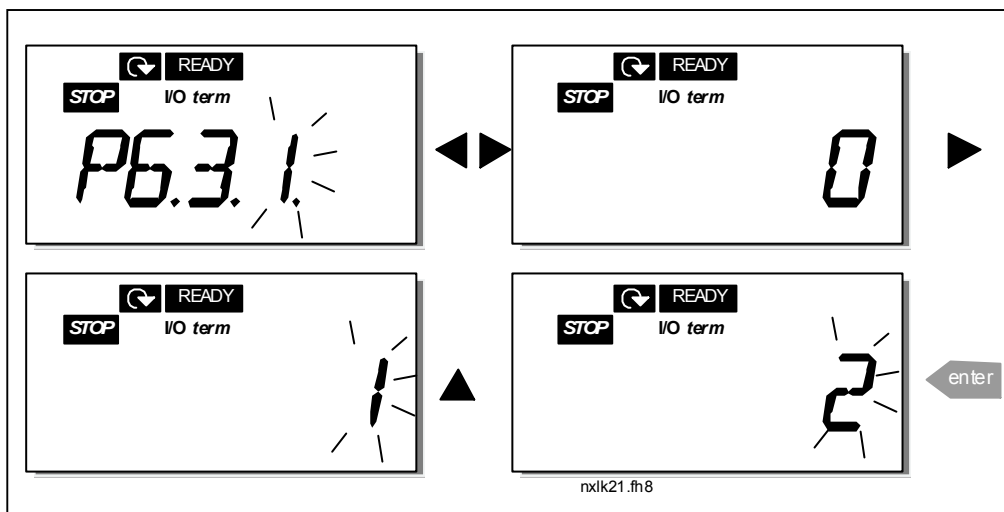

Figure 7-10. Storing and loading of parameter sets

7.3.6.2 Security

The Security submenu (**S6.5**) under the system menu has a function that allows the user to prohibit changes to the parameters.

Parameter lock (P6.5.2)

If the parameter lock is activated the parameter values cannot be edited.

NOTE: This function does not prevent unauthorised editing of parameter values.

Enter the edit mode by pushing the *Menu button right*. Use the *Browser buttons* to change the parameter lock status (**0** = changes enabled, **1** = changes disabled). Accept the change with the *Enter button* or return to the previous level with the *Menu button left*.

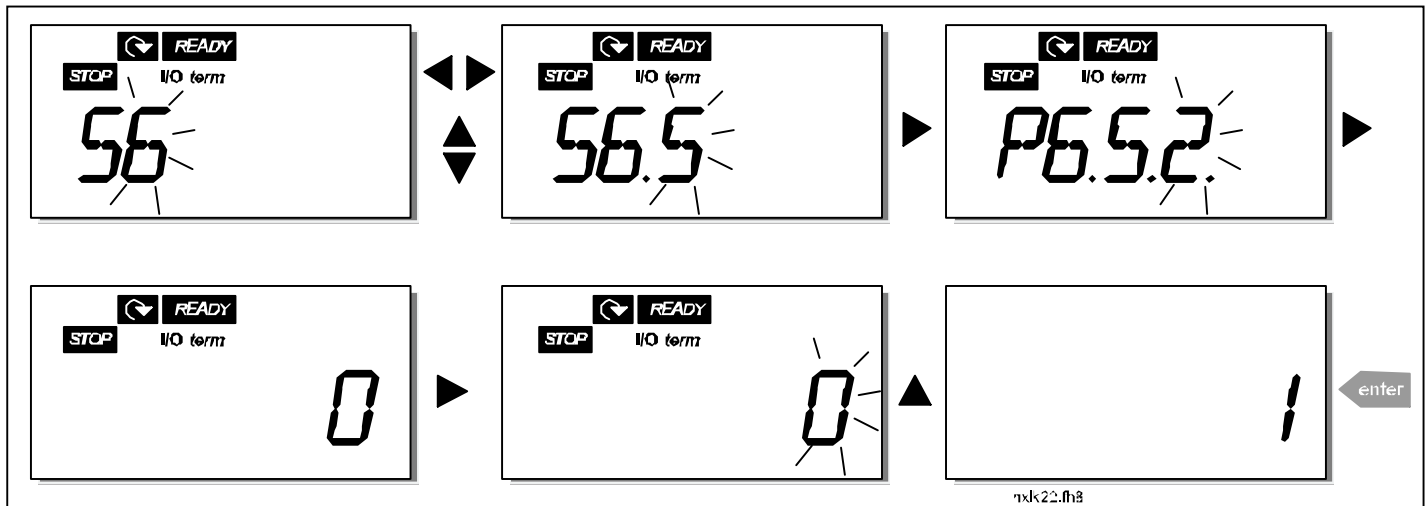

Figure 7-11. Parameter locking

7.3.6.3... Keypad settings

In the submenu **S6.6** under the *System menu* you can further customise your frequency converter operator interface.

Locate the Keypad settings submenu (**S6.6**). Under the submenu, there are two pages (**P#**) associated with the keypad operation, *Default page (P6.6.1)* and *Timeout time (P6.6.3)*

Default page (P6.6.1)

Here you can set the location (page) to which the display automatically moves as the *Timeout time* (see below) has expired or as the power is switched on to the keypad.

Press the *Menu button right* once to enter the edit mode. Pressing the *Menu button right* once again makes you able to edit the number of the submenu/page digit by digit. Confirm the new default page value with the *Enter button*. You can return to the previous step anytime by pushing the *Menu button left*.

Note! If you set a page that does not exist in the menu, the display will automatically move to the last available page in the menu.

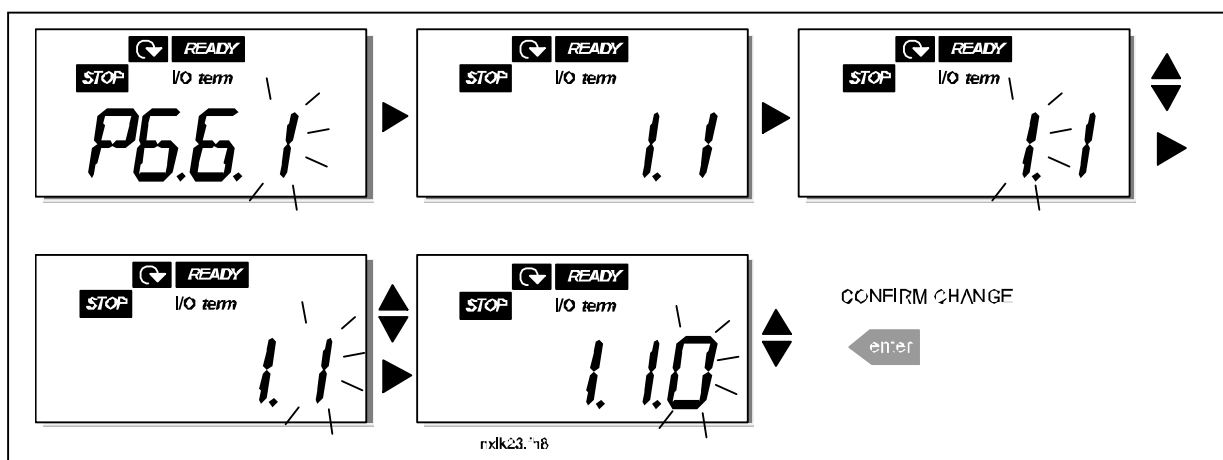

Figure 7-12. Default page function

Automation and Control Solutions

Honeywell
1985 Douglas Drive North
Golden Valley, MIN 55422

Honeywell Limited-Honeywell Limitée
35 Dynamic Drive
Scarborough, Ontario
M1V 4Z9

63-2599

www.honeywell.com

Timeout time (P6.6.3)

The Timeout time setting defines the time after which the keypad display returns to the Default Page (P6.6.1), see above.

Move to the Edit menu by pressing the *Menu button right*. Set the timeout time you want and confirm the change with the *Enter button*. You can return to the previous step anytime by pushing the *Menu button left*.

NOTE: This function cannot be disabled.

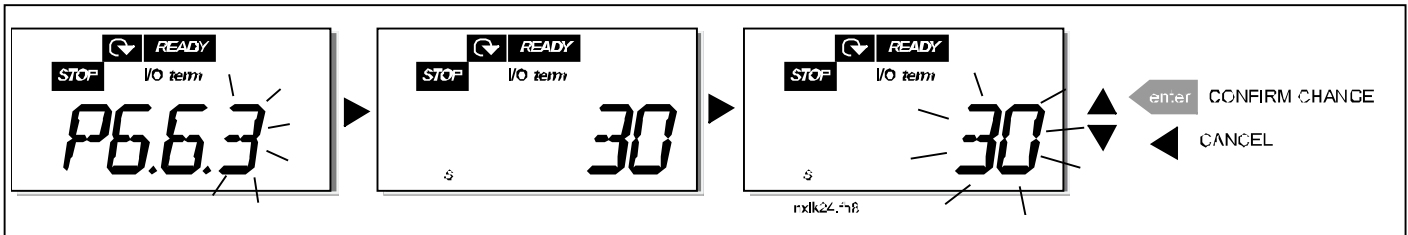

Figure 7-13. Timeout time setting

7.3.6.4 Hardware settings

In the Hardware settings submenu (**S6.7**) you can further customise the settings of the frequency converter with four parameters: **Brake resistor connection, Fan control, HMI acknowledgement timeout and HMI retry**.

Brake resistor connection (P6.7.1)

With this function you can tell the frequency converter whether the brake resistor is connected or not.

- 0 = Not connected (Default)
- 1 = Connected

NOTE! An external brake resistor can be connected to sizes MF3 and bigger. When a brake resistor is not connected, the value of this parameter must not be changed to 1.

Automation and Control Solutions

Honeywell
1985 Douglas Drive North
Golden Valley, MIN 55422

Honeywell Limited-Honeywell Limitée
35 Dynamic Drive
Scarborough, Ontario
M1V 4Z9

63-2599

www.honeywell.com

Fan control (P6.7.2)

Note! Only the higher power modules of MF3 have been equipped with a cooling fan, in lower power modules of MF3 the cooling fan is available as optional equipment.

If the cooling fan has been installed in MF3 it runs continuously, when the power is switched on.

Sizes MF4 and bigger:

This function allows you to control the frequency converter's cooling fan. You can set the fan to run continuously when the power is switched on or depending on the temperature of the unit. If the latter function has been selected the fan is switched on automatically when the heat sink temperature reaches 60°C. The fan receives a stop command when the heat sink temperature falls to 55°C. However the fan runs for about a minute after receiving the stop command, as well as after changing the value from **0** (*Continuous*) to **1** (*Temperature*).

Enter the edit mode by pushing the *Menu button right*. The present mode shown starts to blink. Use the *Browser buttons* to change the fan mode. Accept the change with the *Enter button* or return to the previous level with the *Menu button left*.

See Figure 7-11 for how to change the fan control function.

HMI acknowledge timeout (P6.7.3)

This function allows the user to change the timeout of the HMI acknowledgement time.

Note! If the frequency converter has been connected to the PC with a **normal cable**, the default values of parameters 6.7.3 and 6.7.4 (200 and 5) **must not be changed**.

If the frequency converter has been connected to the PC via a modem and there is delay in transferring messages, the value of par. 6.7.3 must be set according to the delay as follows:

Example:

- Transfer delay between the frequency converter and the PC = 600 ms
- The value of par. 6.7.3 is set to 1200 ms (2 x 600, sending delay + receiving delay)
- The corresponding setting shall be entered in the [Misc]-part of the file NCDrive.ini:
Retries = 5
AckTimeOut = 1200
TimeOut = 6000

It must also be considered that intervals that are shorter than the AckTimeOut-time cannot be used in NC-Drive monitoring.

Enter the edit mode by pushing the *Menu button right*. Use the *Browser buttons* to change the acknowledgement time. Accept the change with the *Enter button* or return to the previous level with the *Menu button left*. See Figure 7-14 for how to change the HMI acknowledgement timeout.

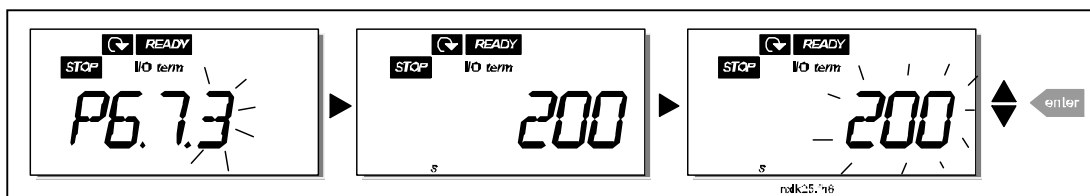

Figure 7-14. HMI acknowledge timeout

Automation and Control Solutions

Honeywell
1985 Douglas Drive North
Golden Valley, MIN 55422

Honeywell Limited-Honeywell Limitée
35 Dynamic Drive
Scarborough, Ontario
M1V 4Z9

63-2599

www.honeywell.com

Number of retries to receive HMI acknowledgement (P6.7.4)

With this parameter you can set the number of times the drive will try receive acknowledgement if this does not succeed within the acknowledgement time (P6.7.3)

Enter the edit mode by pushing the *Menu button right*. The present value shown starts to blink. Use the *Browser buttons* to change the amount of retries. Accept the change with the *Enter button* or return to the previous level with the *Menu button left*.

7.3.6.5.....System information

In the submenu **S6.8** under the *System menu* you can find frequency converter-related hardware and software information as well as operation-related information.

Enter the *Info menu* by pressing the *Menu button right*. Now you can browse through the information pages with the *Browser buttons*.

Counters submenu (S6.8.1)

In the *Counters submenu (S6.8.1)* you can find information related to the frequency converter operation times, i.e. the total numbers of MWh, operation days and operation hours passed so far. Unlike the counters in the trip counters menu, these counters cannot be reset.

Note! The operation time counter (days and hours) runs always, when the power is on.

Page	Counter
C6.8.1.1	MWh counter
C6.8.1.2	Operation day counter
C6.8.1.3	Operation hour counter

Table 7-6. Counter pages

Trip counters submenu (S6.8.2)

Trip counters (menu S6.8.2) are counters the values of which can be reset i.e. restored to zero. You have the following resettable counters at your disposal:

Note! The trip counters run only when the motor is running.

Page	Counter
T6.8.2.1	MWh counter
P6.8.2.2	Clear mWh counter
T6.8.2.3	Operation day counter
T6.8.2.4	Operation hour counter
P6.8.2.5	Clear operation time counter

Table 7-7. Trip counter pages

Automation and Control Solutions

Honeywell
1985 Douglas Drive North
Golden Valley, MIN 55422

Honeywell Limited-Honeywell Limitée
35 Dynamic Drive
Scarborough, Ontario
M1V 4Z9

63-2599

www.honeywell.com

Example: When you want to reset the operation counters, you should do the following:

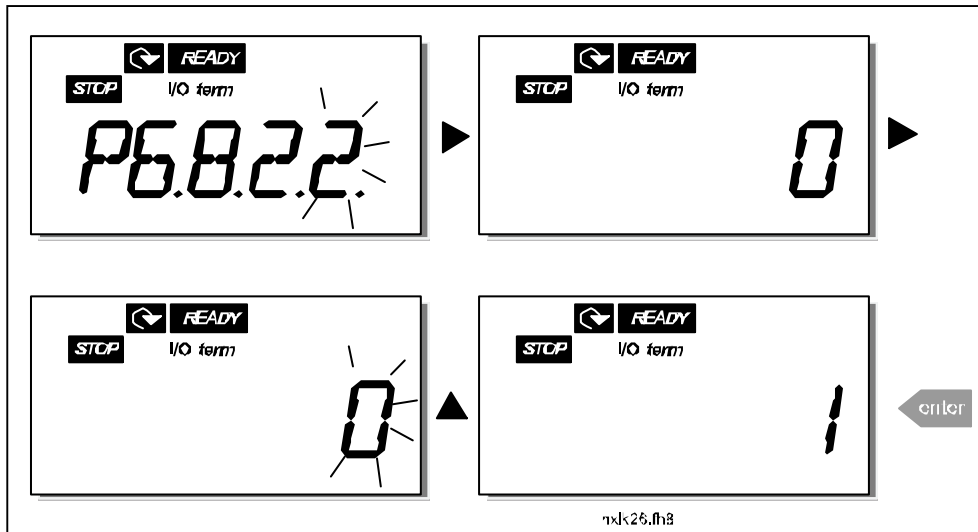

Figure 7-15. MWh counter reset

Software info submenu (S6.8.3)

The following information can be found under the Software info submenu (S6.8.3):

Page	Content
I6.8.3.1	Software package
I6.8.3.2	System software version
I6.8.3.3	Firmware interface
I6.8.3.4	System load

Table 7-8. Software information pages

Application information submenu (S6.8.4)

You can find the following information from the Application info submenu (S6.8.4)

Page	Content
A6.8.4.1	Application
D6.8.4.1.1	Application id
D6.8.4.1.2	Version
D6.8.4.1.3	Firmware interface

Table 7-9. Application information pages

Hardware information submenu (S6.8.5)

You can find the following information from the Hardware info submenu (S6.8.5)

Page	Content
I6.8.5.2	Unit voltage
I6.8.5.3	Brake chopper
I6.8.5.4	Brake resistor

Table 7-10. Hardware information pages

Automation and Control Solutions

Honeywell
1985 Douglas Drive North
Golden Valley, MIN 55422

Honeywell Limited-Honeywell Limitée
35 Dynamic Drive
Scarborough, Ontario
M1V 4Z9

63-2599

www.honeywell.com

Connected options submenu (S6.8.6)

The Connected options submenu (S6.8.6) shows the following information on the option board connected to the frequency converter:

Page	Content
E6.8.6.1	Option board
E6.8.6.1.1	Option board status
E6.8.6.1.2	Program version

Table 7-11. Connected options submenu

In this submenu you find information about the option board connected to the control board (see chapter 6.2)

You can check the status of the slot by entering the board submenu with the *Menu button right* and using the *Browser buttons*. Push the *Menu button right* again to display the status of the board. The keypad will also display the program version of the respective board when you push either one of the *Browser buttons*.

For more information on the expander board-related parameters, see Chapter 7.3.7.

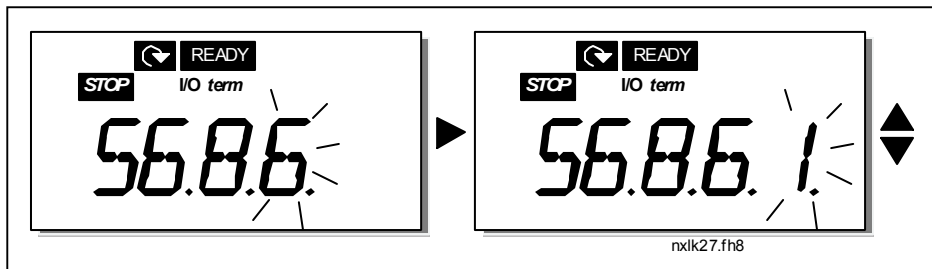

Figure 7-16. Expander board information menu

7.3.6.6 AI mode

The parameter P6.9.2 selects the analogue input mode

Note! Make sure that the jumper selections correspond to the selections of this parameter. See Figure 6-16.

7.3.6.7 Fieldbus parameters

The parameters of Modbus protocol are only shortly described here. For further information, please refer to NX Modbus Option Board User's Manual.

Expander board communication status (I6.10.1)

With this function you can check the status of the RS 485 termination resistor

- 0 = Not connected
- 1 = Connected

Automation and Control Solutions

Honeywell
1985 Douglas Drive North
Golden Valley, MIN 55422

Honeywell Limited-Honeywell Limitée
35 Dynamic Drive
Scarborough, Ontario
M1V 4Z9

63-2599

www.honeywell.com

Fieldbus protocol (P6.10.2)

With this function you can select the fieldbus communications protocol.

- 0 = Not used
- 1 = Modbus protocol

Slave address (P6.10.3)

Set here the slave address for the modbus protocol. You can set any address between 1 and 255.

Baud rate (P6.10.4)

Selects the baud rate used with the modbus communication.

- 0 = 300 baud
- 1 = 600 baud
- 2 = 1200 baud
- 3 = 2400 baud
- 4 = 4800 baud
- 5 = 9600 baud
- 6 = 19200 baud
- 7 = 38400 baud
- 8 = 57600 baud

Stop bits (P6.10.5)

Set the number of stop bits used in Modbus communication

- 0 = 1 stop bit
- 1 = 2 stop bits

Parity type (P6.10.6)

Here you can select the type of parity checking used with the modbus communication.

- 0 = None
- 1 = Even
- 2 = Odd

Communication time-out (P6.10.7)

If communication between two messages is broken for a longer time than that defined by this parameter, a communication error is initiated. If the value of this parameter is 0, the function is not used.

- 0 = Not used
- 1 = 1 second
- 2 = 2 seconds, etc

Automation and Control Solutions

Honeywell
1985 Douglas Drive North
Golden Valley, MIN 55422

Honeywell Limited-Honeywell Limitée
35 Dynamic Drive
Scarborough, Ontario
M1V 4Z9

63-2599

www.honeywell.com

7.3.7 Expander board menu (E7)

The *Expander board menu* makes it possible for the user 1) to see which expander board is connected to the control board and 2) to reach and edit the parameters associated with the expander board.

Enter the following menu level (**E#**) with the *Menu button right*. You can view and edit the parameter values in the same way as described in chapter 7.3.2.

7.4 Further keypad functions

The NXL control keypad embodies additional application-related functions. See Multicontrol Application Manual for more information.

Automation and Control Solutions

Honeywell
1985 Douglas Drive North
Golden Valley, MIN 55422

Honeywell Limited-Honeywell Limitée
35 Dynamic Drive
Scarborough, Ontario
M1V 4Z9

63-2599

www.honeywell.com

8. COMMISSIONING

8.1 Safety

Before commissioning, note the following directions and warnings:

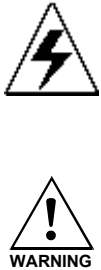
	1	Internal components and circuit boards of the frequency converter (except for the galvanically isolated I/O terminals) are live when NXL is connected to mains potential. Coming into contact with this voltage is extremely dangerous and may cause death or severe injury.
	2	The motor terminals U, V, W and the DC-link/brake resistor terminals -/+ are live when NXL is connected to mains, even if the motor is not running.
	3	The control I/O-terminals are isolated from the mains potential. However, the relay outputs and other I/O-terminals may have a dangerous control voltage present even when NXL is disconnected from mains.
	4	Do not make any connections with the frequency converter connected to the mains.
	5	After having disconnected the frequency converter from the mains, wait until the fan stops and the indicators on the keypad go out (if no keypad is attached see the indicator through the keypad base). Wait 5 more minutes before doing any work on NXL connections. Do not even open the cover before this time has expired.
	6	Before connecting the frequency converter to mains make sure that the NXL front cover is closed.

8.2 Commissioning of the frequency converter

- 1** Read carefully the safety instructions in Chapter 1 and above and follow them.
- 2** After the installation, pay attention to:
 - that both the frequency converter and the motor are grounded.
 - that the mains and motor cables comply with the requirements given in Chapter 6.1.1.
 - that the control cables are located as far as possible from the power cables (see Chapter 6.1.2, step 3) , the shields of the shielded cables are connected to protective earth . The wires may not touch the electrical components of the frequency converter.
 - **For option boards only:** make sure that the common ends of digital input groups are connected to +24V or ground of the I/O terminal or the external supply.
- 3** Check the quality and quantity of cooling air (Chapter 5.2).
- 4** Check the inside of the frequency converter for condensation.
- 5** Check that all Start/Stop switches connected to the I/O terminals are in **Stop**-position.
- 6** Connect the frequency converter to mains.

Automation and Control Solutions

Honeywell
1985 Douglas Drive North
Golden Valley, MIN 55422

Honeywell Limited-Honeywell Limitée
35 Dynamic Drive
Scarborough, Ontario
M1V 4Z9

63-2599

www.honeywell.com

- 7** Set the parameters of group 1 according to the requirements of your application. At least the following parameters should be set:
- motor nominal voltage
 - motor nominal frequency
 - motor nominal speed
 - motor nominal current

You will find the values needed for the parameters on the motor rating plate.



8 Perform run test **without motor**

Perform either Test A or Test B:

A Controls from the I/O terminals:

- a) Turn the Start/Stop switch to ON position.
- b) Change the frequency reference (potentiometer)
- c) Check in the Monitoring menu (M1) that the value of Output frequency changes according to the change of frequency reference.
- d) Turn the Start/Stop switch to OFF position.

B Control from the control keypad:

- a) Change the control from the I/O terminals to the keypad as advised in Chapter 7.3.3.1.
- b) Push the Start button on the keypad  .
- c) Move over to the Keypad Control Menu (K3) and Keypad Reference submenu (Chapter 7.3.3) and change the frequency reference using the Browser buttons  .
- d) Check in the Monitoring menu (M1) that the value of Output frequency changes according to the change of frequency reference.
- e) Push the Stop button on the keypad  .

- 9** Run the start-up tests without the motor being connected to the process, if possible. If this is not possible, secure the safety of each test prior to running it. Inform your co-workers of the tests.
- a) *Switch off the supply voltage and wait up until the drive has stopped **as advised at Chapter 8.1, step 5.***
 - b) *Connect the motor cable to the motor and to the motor cable terminals of the frequency converter.*
 - c) *See to that all Start/Stop switches are in Stop positions.*
 - d) *Switch the mains ON*
 - e) *Repeat test **8A** or **8B.***
- 10** Connect the motor to the process (if the startup test was run without the motor being connected)
- a) *Before running the tests, make sure that this can be done safely.*
 - b) *Inform your co-workers of the tests.*
 - c) *Repeat test **8A** or **8B.***

8.3 Basic parameters

On the next pages you will find the list of parameters that are essential for the commissioning of the frequency converter. You will find more details of these and other special parameters in the Multi-Control Application manual.

Note! If you wish to edit the special parameters, you must set the value of par. 2.1.22 to **0**.

Column explanations:

Code	= Location indication on the keypad; Shows the operator the present param. number
Parameter	= Name of parameter
Min	= Minimum value of parameter
Max	= Maximum value of parameter
Unit	= Unit of parameter value; Given if available
Default	= Value preset by factory
Cust	= Customer's own setting
ID	= ID number of the parameter (used with PC tools)
	= On the parameter code: parameter value can only be changed after the FC has been stopped.

8.3.1 Monitoring values (Control keypad: menu M1)

The monitoring values are the actual values of parameters and signals as well as statuses and measurements. Monitoring values cannot be edited. See Chapter 7.3.1 for more information.

Code	Parameter	Unit	ID	Description
V1.1	Output frequency	Hz	1	Frequency to the motor
V1.2	Frequency reference	Hz	25	
V1.3	Motor speed	rpm	2	Calculated motor speed
V1.4	Motor current	A	3	Measured motor current
V1.5	Motor torque	%	4	Calculated actual torque/nominal torque of the unit
V1.6	Motor power	%	5	Calculated actual power/nominal power of the unit
V1.7	Motor voltage	V	6	Calculated motor voltage
V1.8	DC-link voltage	V	7	Measured DC-link voltage
V1.9	Unit temperature	°C	8	Heat sink temperature
V1.10	Analogue input 1	V	13	AI1
V1.11	Analogue input 2	mA	14	AI2
V1.12	Analogue output current	mA	26	AO1
V1.13	Analogue output current 1, expander board	mA	31	
V1.14	Analogue output current 2, expander board	mA	32	
V1.15	DIN1, DIN2, DIN3		15	Digital input statuses
V1.16	DIE1, DIE2, DIE3		33	I/O expander board: Digital input statuses
V1.17	RO1		34	Relay output 1 status
V1.18	ROE1, ROE2, ROE3		35	I/O exp. board: Relay output statuses
V1.19	DOE 1		36	I/O exp. board: Digital output 1 status
V1.20	PID Reference	%	20	In percent of the maximum frequency
V1.21	PID Actual value	%	21	In percent of the maximum actual value
V1.22	PID Error value	%	22	In percent of the maximum error value
V1.23	PID Output	%	23	In percent of the maximum output value

Table 8-1. Monitoring values

Automation and Control Solutions

Honeywell
1985 Douglas Drive North
Golden Valley, MIN 55422

Honeywell Limited-Honeywell Limitée
35 Dynamic Drive
Scarborough, Ontario
M1V 4Z9

63-2599

www.honeywell.com

8.3.2 Basic parameters (Control keypad: Menu P2 → B2.1)

Code	Parameter	Min	Max	Unit	Default	Cust	ID	Note
P2.1.1	Min frequency	0,00	Par. 2.1.2	Hz	0,00		101	
P2.1.2	Max frequency	Par. 2.1.1	320,00	Hz	50,00		102	NOTE: If f_{max} > than the motor synchronous speed, check suitability for motor and drive system
P2.1.3	Acceleration time 1	0,1	3000,0	s	1,0		103	
P2.1.4	Deceleration time 1	0,1	3000,0	s	1,0		104	
P2.1.5	Current limit	$0,1 \times I_L$	$2,5 \times I_L$	A	$1,5 \times I_L$		107	NOTE: Formulas apply approximately for frequency converters up to MF3. For greater sizes, consult the factory.
P2.1.6	Nominal voltage of the motor	180	690	V	NXL2:230V NXL5:400V		110	
P2.1.7	Nominal frequency of the motor	30,00	320,00	Hz	50,00		111	Check the rating plate of the motor
P2.1.8	Nominal speed of the motor	300	20 000	rpm	1440		112	The default applies for a 4-pole motor and a nominal size frequency converter.
P2.1.9	Nominal current of the motor	$1 \times I_L$	$2,5 \times I_L$	A	I_L		113	Check the rating plate of the motor
P2.1.10	Motor $\cos\phi$	0,30	1,00		0,85		120	Check the rating plate of the motor
P2.1.11	Start function	0	1		0		505	0=Ramp 1=Flying start
P2.1.12	Stop function	0	1		0		506	0=Coasting 1=Ramp
P2.1.13	U/f optimisation	0	1		0		109	0=Not used 1=Automatic torque boost
P2.1.14	I/O reference	0	4		0		117	0=AI1 1=AI2 2=Keypad reference 3=Fieldbus reference (FBSpeedReference) 4=Motor potentiometer
P2.1.15	AI2 signal range	1	2		2		390	Not used if AI2 Custom min > 0% or AI2 custom max. < 100% 1=0mA – 20mA 2=4mA – 20mA 3=0V – 10V 4=2V – 10V

Automation and Control Solutions

Honeywell
1985 Douglas Drive North
Golden Valley, MIN 55422

Honeywell Limited-Honeywell Limitée
35 Dynamic Drive
Scarborough, Ontario
M1V 4Z9

63-2599

www.honeywell.com

P2.1.16	Analogue output function	0	12		1	307	<ul style="list-style-type: none"> 0=Not used 1=Output freq. (0—f_{max}) 2=Freq. reference (0—f_{max}) 3=Motor speed (0—Motor nominal speed) 4=Output current (0—I_{nMotor}) 5=Motor torque (0—T_{nMotor}) 6=Motor power (0—P_{nMotor}) 7=Motor voltage (0—U_{nMotor}) 8=DC-link volt (0—U_{nMotor}) 9=PI controller ref. value 10=PI contr. act. value 1 11=PI contr. error value 12=PI controller output
P2.1.17	DIN2 function	0	10		1	319	<ul style="list-style-type: none"> 0=Not used 1=Start Reverse 2=Reverse 3=Stop pulse 4=External fault, cc 5=External fault, oc 6=Run enable 7=Preset speed 2 8= Motor pot. UP (cc) 9= Disable PID (Direct freq. reference) 10=Interlock 2
P2.1.18	DIN3 function	0	13		6	301	<ul style="list-style-type: none"> 0=Not used 1=Reverse 2=External fault, cc 3=External fault, oc 4=Fault reset 5=Run enable 6=Preset speed 1 7=Preset speed 2 8=DC-braking command 9=Motor pot. UP (cc) 10=Motor pot. DOWN (cc) 11=Disable PID (PID control selection) 12=PID Keypad ref. 2 selection 13=Interlock 3
P2.1.19	Preset speed 1	0,00	Par. 2.1.2	Hz	10,00	105	
P2.1.20	Preset speed 2	0,00	Par. 2.1.2	Hz	50,00	106	
P2.1.21	Automatic restart	0	1		0	731	<ul style="list-style-type: none"> 0=Not used 1=Used
P2.1.22	Parameter conceal	0	1		1	115	<ul style="list-style-type: none"> 0=All parameters and menus visible 1=Only group P2.1 and menus M1 – H5 visible

Table 8-2. Basic parameters B2.1

9. FAULT TRACING

When a fault is detected by the frequency converter control electronics, the drive is stopped and the symbol **F** together with the ordinal number of the fault and the fault code appear on the display. The fault can be reset with the *Reset button* on the control keypad or via the I/O terminal. The faults are stored in the Fault history menu (H5) which can be browsed. The different fault codes you will find in the table below.

The fault codes, their causes and correcting actions are presented in the table below. The shadowed faults are A faults only. The items written in white on black background present faults for which you can program different responses in the application. See parameter group Protections.

Fault code	Fault	Possible cause	Correcting measures
1	Overcurrent	Frequency converter has detected too high a current ($>4 \cdot I_n$) in the motor cable: <ul style="list-style-type: none"> – sudden heavy load increase – short circuit in motor cables – unsuitable motor 	Check loading. Check motor size. Check cables.
2	Overvoltage	The DC-link voltage has exceeded the limits defined in. <ul style="list-style-type: none"> – too short a deceleration time – high overvoltage spikes in utility 	Make the deceleration time longer.
3	Earth fault	Current measurement has detected that the sum of motor phase current is not zero. <ul style="list-style-type: none"> – insulation failure in cables or motor 	Check motor cables and motor.
5	Charging switch	The charging switch is open, when the START command has been given. <ul style="list-style-type: none"> – faulty operation – component failure 	Reset the fault and restart. Should the fault re-occur, contact the distributor near to you.
8	System fault	<ul style="list-style-type: none"> - component failure - faulty operation 	Reset the fault and restart. Should the fault re-occur, contact the distributor near to you.
9	Undervoltage	DC-link voltage is under the voltage limits defined in. <ul style="list-style-type: none"> – most probable cause: too low a supply voltage – frequency converter internal fault 	In case of temporary supply voltage break reset the fault and restart the frequency converter. Check the supply voltage. If it is adequate, an internal failure has occurred. Contact the distributor near to you.
11	Output phase supervision	Current measurement has detected that there is no current in one motor phase.	Check motor cable and motor.
13	Frequency converter under-temperature	Heatsink temperature is under -10°C	
14	Frequency converter overtemperature	Heatsink temperature is over 90°C . Overtemperature warning is issued when the heatsink temperature exceeds 85°C .	Check the correct amount and flow of cooling air. Check the heatsink for dust. Check the ambient temperature. Make sure that the switching frequency is not too high in relation to ambient temperature and motor load.

15	Motor stalled	Motor stall protection has tripped.	Check motor.
16	Motor overtemperature	Motor overheating has been detected by frequency converter motor temperature model. Motor is overloaded.	Decrease the motor load. If no motor overload exists, check the temperature model parameters.
17	Motor underload	Motor underload protection has tripped.	
22 23	EEPROM checksum fault	Parameter save fault – faulty operation – component failure	Contact the distributor near to you
24	Counter fault	Values displayed on counters are incorrect	
25	Microprocessor watchdog fault	– faulty operation – component failure	Reset the fault and restart. Should the fault re-occur, contact the distributor near to you.
26	Start-up prevented	Start-up of the drive has been prevented.	Cancel prevention of start-up.
29	Thermistor fault	The thermistor input of option board has detected increase of the motor temperature	Check motor cooling and loading Check thermistor connection (If thermistor input of the option board is not in use it has to be short circuited)
34	Internal bus communication	Ambient interference or defective hardware	Should the fault re-occur, contact the distributor near to you.
37	Device change	Option board changed. Different power rating of drive.	Reset
38	Device added	Option board added. Drive of different power rating added.	Reset
39	Device removed	Option board removed. Drive removed.	Reset
40	Device unknown	Unknown option board or drive.	Contact the distributor near to you.
41	IGBT temperature	IGBT Inverter Bridge overtemperature protection has detected too high a short term overload current	Check loading. Check motor size.
42	Brake resistor overtemperature	Brake resistor overtemperature protection has detected too heavy braking	Set the deceleration time longer. Use external brake resistor.
44	Device change	Option board changed. Different power rating of drive.	Reset Note: No fault time data record! Note: Application parameter values restored to default.
45	Device added	Option board added. Drive of different power rating added.	Reset Note: No fault time data record! Note: Application parameter values restored to default.
50	Analogue input $I_{in} < 4\text{mA}$ (selected signal range 4 to 20 mA)	Current at the analogue input is $< 4\text{mA}$. – control cable is broken or loose – signal source has failed	Check the current loop circuitry.
51	External fault	Digital input fault.	
52	Keypad communication fault	The connection between the control keypad and the frequency converter is broken.	Check keypad connection and possible keypad cable.

53	Fieldbus fault	The data connection between the fieldbus Master and the fieldbus board is broken	Check installation. If installation is correct contact the nearest distributor.
54	Slot fault	Defective option board or slot	Check board and slot. Contact the nearest distributor.
55	Actual value supervision	Actual value has exceeded or fallen below (depending on par. 2.7.22) the actual value supervision limit (par. 2.7.23)	

Table 9-1. Fault codes

Automation and Control Solutions

Honeywell
1985 Douglas Drive North
Golden Valley, MIN 55422

Honeywell Limited-Honeywell Limitée
35 Dynamic Drive
Scarborough, Ontario
M1V 4Z9

63-2599

www.honeywell.com

10. DESCRIPTION OF EXPANDER BOARD NXOPTAA

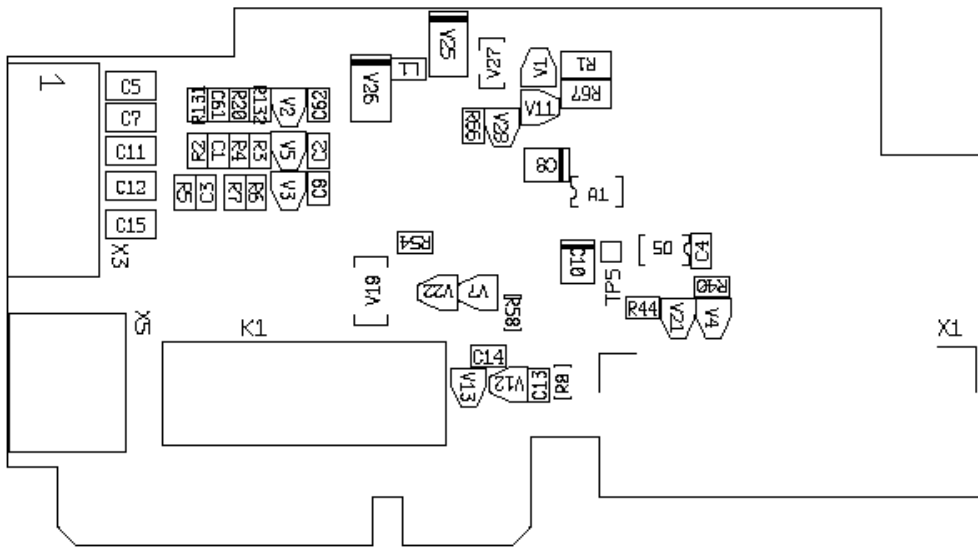

Description: I/O expander board with one relay output, one open collector output and three digital inputs.

- Allowed slots: **NXL** board slot
- Type ID: 16705
- Terminals: Two terminal blocks; Screw terminals (M2.6 and M3); No coding
- Jumpers: None
- Board parameters: None

I/O terminals on NXOPTAA

Terminal	Parameter setting	Description
X3		
1	+24V	Control voltage output; voltage for switches etc, max. 150 mA
2	GND	Ground for controls, e.g for +24 V and DO
3	DIN1	DIGIN:x.1 Digital input 1
4	DIN2	DIGIN:x.2 Digital input 2
5	DIN3	DIGIN:x.3 Digital input 3
6	DO1	DIOUT:x.1 Open collector output, 50mA/48V
X5		
24	RO1/NC	DIOUT:x.2 Relay output 1 (NO) Switching capacity: 24VDC/8A 250VAC/8A 125VDC/0,4A
25	RO1/C	
26	RO1/NO	

Table 10-1. I/O terminals of board NXOPTAA

Note! The +24 V control voltage terminal can also be used to power the control module (but not the power module).

Automation and Control Solutions

Honeywell
1985 Douglas Drive North
Golden Valley, MIN 55422

Honeywell Limited-Honeywell Limitée
35 Dynamic Drive
Scarborough, Ontario
M1V 4Z9

63-2599

www.honeywell.com

Multi-Control Application (Software ALFIF20) Ver. 1.02

INDEX

- 1. INTRODUCTION 2
- 2. CONTROL I/O 3
- 3. MULTI-CONTROL APPLICATION – PARAMETER LISTS 4
 - 3.1 *Monitoring values (Control keypad: menu M1)* 4
 - 3.2 *Basic parameters (Control keypad: Menu P2 → P2.1)* 5
 - 3.3 *Input signals (Control keypad: Menu P2 → P2.2)* 7
 - 3.4 *Output signals (Control keypad: Menu P2 → P2.3)* 9
 - 3.5 *Drive control parameters (Control keypad: Menu P2 → P2.4)* 10
 - 3.6 *Prohibit frequency parameters (Control keypad: Menu P2 → P2.5)* 10
 - 3.7 *Motor control parameters (Control keypad: Menu P2 → P2.6)* 11
 - 3.8 *Protections (Control keypad: Menu P2 → P2.7)* 12
 - 3.9 *Autorestart parameters (Control keypad: Menu P2 → P2.8)* 13
 - 3.10 *PID reference parameters (Control keypad: Menu P2 → P2.9)* 13
 - 3.11 *Pump & Fan control parameters (Control keypad: Menu P2 → P2.10)* 14
 - 3.12 *Keypad control (Control keypad: Menu K3)* 15
 - 3.13 *System menu (Control keypad: Menu S6)* 15
 - 3.14 *Expander boards (Control keypad: Menu E7)* 15
- 4. DESCRIPTION OF PARAMETERS 16
 - 4.1 *BASIC PARAMETERS* 16
 - 4.2 *INPUT SIGNALS* 21
 - 4.3 *OUTPUT SIGNALS* 25
 - 4.4 *DRIVE CONTROL* 28
 - 4.5 *PROHIBIT FREQUENCIES* 31
 - 4.6 *MOTOR CONTROL* 32
 - 4.7 *PROTECTIONS* 35
 - 4.8 *AUTO RESTART PARAMETERS* 43
 - 4.9 *PID REFERENCE PARAMETERS* 44
 - 4.10 *PUMP AND FAN CONTROL* 49
 - 4.11 *KEYPAD CONTROL PARAMETERS* 58
- 5. CONTROL SIGNAL LOGIC IN MULTI-CONTROL APPLICATION 59

Multicontrol Application

1. Introduction

The Multicontrol Application for NXL uses direct frequency reference from the analogue input 1 as a default. However, a PID controller can be used e.g. in pump and fan applications, which offers versatile internal measuring and adjusting functions. This means that external devices are not necessary. When the drive is commissioned, the only visible parameter group is B2.1 (Basic parameters). The special parameters can be browsed and edited after changing the value of par. 2.1.22 (Parameter conceal).

The direct frequency reference can be used for the control without the PID controller and it can be selected from the analogue inputs, fieldbus, keypad, preset speeds or motor potentiometer.

Special parameters for Pump and Fan Control (**Group P2.10**) can be browsed and edited after changing the value of **par 2.9.1 to 2** (Pump and fan control activated).

The PID controller reference can be selected from the analogue inputs, fieldbus, PID keypad reference 1 or by enabling the PID keypad reference 2 via digital input. The PID controller actual value can be selected from the analogue inputs, fieldbus or the actual values of the motor. PID controller can also be used when the frequency converter is controlled via fieldbus or the control keypad.

- Digital inputs DIN2, DIN3, (DIN4) and optional dig. inputs DIE1, DIE2, DIE3 are freely programmable.
- Internal and optional digital/relay and analogue outputs are freely programmable.
- Analogue input 1 can be programmed as current input, voltage input or **digital input DIN4**.

NOTE! If the analogue input 1 has been programmed as DIN4 with parameter 2.2.6 (AI1 Signal Range), check that the jumper selections (Figure 1- 1) are correct.

Additional functions:

- The PID controller can be used from control places I/O, keypad and fieldbus
- Sleep function
- Actual value supervision function: fully programmable; off, warning, fault
- Programmable Start/Stop and Reverse signal logic
- Reference scaling
- 2 Preset speeds
- Analogue input range selection, signal scaling, inversion and filtering
- Frequency limit supervision
- Programmable start and stop functions
- DC-brake at start and stop
- Prohibit frequency area
- Programmable U/f curve and U/f optimisation
- Adjustable switching frequency
- Autorestart function after fault
- Protections and supervisions (all fully programmable; off, warning, fault):
 - Current input fault
 - External fault
 - Output phase
 - Under voltage
 - Earth fault
 - Motor thermal, stall and underload protection
 - Thermistor
 - Fieldbus communication
 - Option board

2. Control I/O

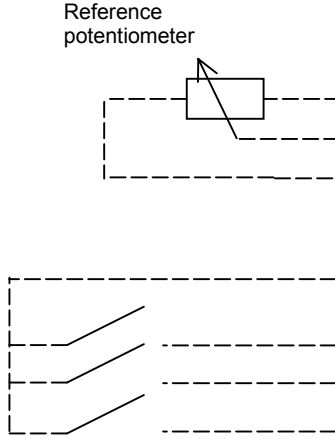

Terminal	Signal	Description
1	+10V _{ref}	Reference output Voltage for potentiometer, etc.
2	AI1+	Analogue input, voltage range 0—10V DC. Voltage input frequency reference Can be programmed as DIN4
3	AI1-	I/O Ground Ground for reference and controls
4	AI2+	Analogue input, voltage range 0—10V DC, or current range 0/4—20mA Current input frequency reference (programmable)
5	AI2-	
6	+24V	Control voltage output Voltage for switches, etc. max 0.1 A
7	GND	I/O ground Ground for reference and controls
8	DIN1	Start forward Contact closed = start forward
9	DIN2	Start reverse (programmable) Contact closed = start reverse
10	DIN3	Multi-step speed selection 1 (programmable) Contact closed = multi-step speed
11	GND	I/O ground Ground for reference and controls
18	AO1+	Output frequency Analogue output Programmable Range 0—20 mA/R _L , max. 500Ω
19	AO1-	
A	RS 485	Serial bus Termination resistor is internally connected with a jumper
B	RS 485	Serial bus Termination resistor is internally connected with a jumper
21	RO1	Relay output 1 FAULT Programmable
22	RO1	
23	RO1	

Table 1- 1. Multicontrol application default I/O configuration (with 2-wire transmitter).

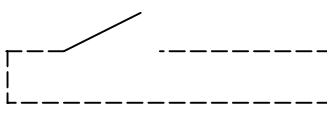

Terminal	Signal	Description
1	+10V _{ref}	Reference output Voltage for potentiometer, etc.
2	AI1+ or DIN 4	Analogue input, voltage range 0—10V DC Voltage input frequency reference Can be programmed as DIN4
3	AI1-	I/O Ground Ground for reference and controls
4	AI2+	Analogue input, current range 0—20mA Current input frequency reference
5	AI2-	
6	+ 24 V	Control voltage output

Table 1- 2. The programming of AI1 as DIN4

3. Multi-Control Application – Parameter lists

On the next pages you will find the lists of parameters within the respective parameter groups. The parameter descriptions are given on pages 16 to 43.

Column explanations:

Code	=	Location indication on the keypad; Shows the operator the present param. number
Parameter	=	Name of parameter
Min	=	Minimum value of parameter
Max	=	Maximum value of parameter
Unit	=	Unit of parameter value; Given if available
Default	=	Value preset by factory
Cust	=	Customer's own setting
ID	=	ID number of the parameter (used with PC tools)
	=	On the parameter code: parameter value can only be changed after the FC has been stopped.

3.1 Monitoring values (Control keypad: menu M1)

The monitoring values are the actual values of parameters and signals as well as statuses and measurements. Monitoring values cannot be edited.
See NXL User's Manual, Chapter 7.3.1 for more information.

Code	Parameter	Unit	ID	Description
V1.1	Output frequency	Hz	1	Frequency to the motor
V1.2	Frequency reference	Hz	25	
V1.3	Motor speed	rpm	2	Calculated motor speed
V1.4	Motor current	A	3	Measured motor current
V1.5	Motor torque	%	4	Calculated actual torque/nominal torque of the unit
V1.6	Motor power	%	5	Calculated actual power/nominal power of the unit
V1.7	Motor voltage	V	6	Calculated motor voltage
V1.8	DC-link voltage	V	7	Measured DC-link voltage
V1.9	Unit temperature	°C	8	Heat sink temperature
V1.10	Analogue input 1	V	13	AI1
V1.11	Analogue input 2	mA	14	AI2
V1.12	Analogue output current	mA	26	AO1
V1.13	Analogue output current 1, expander board	mA	31	
V1.14	Analogue output current 2, expander board	mA	32	
V1.15	DIN1, DIN2, DIN3		15	Digital input statuses
V1.16	DIE1, DIE2, DIE3		33	I/O expander board: Digital input statuses
V1.17	RO1		34	Relay output 1 status
V1.18	ROE1, ROE2, ROE3		35	I/O exp. board: Relay output statuses
V1.19	DOE 1		36	I/O exp. board: Digital output 1 status
V1.20	PID Reference	%	20	In percent of the maximum process reference
V1.21	PID Actual value	%	21	In percent of the maximum actual value
V1.22	PID Error value	%	22	In percent of the maximum error value
V1.23	PID Output	%	23	In percent of the maximum output value

Table 1- 3. Monitoring values

3.2 Basic parameters (Control keypad: Menu P2 → P2.1)

Code	Parameter	Min	Max	Unit	Default	Cust	ID	Note
P2.1.1	Min frequency	0,00	Par. 2.1.2	Hz	0,00		101	
P2.1.2	Max frequency	Par. 2.1.1	320,00	Hz	50,00		102	NOTE: If f_{max} > than the motor synchronous speed, check suitability for motor and drive system
P2.1.3	Acceleration time 1	0,1	3000,0	s	1,0		103	
P2.1.4	Deceleration time 1	0,1	3000,0	s	1,0		104	
P2.1.5	Current limit	$0,1 \times I_L$	$2,5 \times I_L$	A	$1,5 \times I_L$		107	NOTE: Formulas apply approximately for frequency converters up to MF3. For greater sizes, consult the factory.
P2.1.6	Nominal voltage of the motor	180	690	V	NXL2:230v NXL5:400v		110	
P2.1.7	Nominal frequency of the motor	30,00	320,00	Hz	50,00		111	Check the rating plate of the motor
P2.1.8	Nominal speed of the motor	300	20 000	rpm	1440		112	The default applies for a 4-pole motor and a nominal size frequency converter.
P2.1.9	Nominal current of the motor	$1 \times I_L$	$2,5 \times I_L$	A	I_L		113	Check the rating plate of the motor
P2.1.10	Motor cosφ	0,30	1,00		0,85		120	Check the rating plate of the motor
P2.1.11	Start function	0	1		0		505	0=Ramp 1=Flying start
P2.1.12	Stop function	0	1		0		506	0=Coasting 1=Ramp
P2.1.13	U/f optimisation	0	1		0		109	0=Not used 1=Automatic torque boost
P2.1.14	I/O reference	0	4		0		117	0=AI1 1=AI2 2=Keypad reference 3=Fieldbus reference (FBSpeedReference) 4=Motor potentiometer
P2.1.15	AI2 signal range	1	4		2		390	Not used if AI2 Custom min <> 0% or AI2 custom max. <> 100% 1=0—20 mA 2=4—20 mA 3=0V – 10V 4=2V – 10V
P2.1.16	Analogue output function	0	12		1		307	0=Not used 1=Output freq. (0— f_{max}) 2=Freq. reference (0— f_{max}) 3=Motor speed (0—Motor nominal speed) 4=Output current (0— I_{nMotor}) 5=Motor torque (0— T_{nMotor}) 6=Motor power (0— P_{nMotor}) 7=Motor voltage (0— U_{nMotor}) 8=DC-link volt (0— U_{nMotor}) 9=PI controller ref. value 10=PI contr. act. value 1 11=PI contr. error value 12=PI controller output

P2.1.17	DIN2 function	0	10		1		319	<ul style="list-style-type: none"> 0=Not used 1=Start Reverse (DIN1=Start forward) 2=Reverse (DIN1=Start) 3=Stop pulse (DIN1=Start pulse) 4=External fault, cc 5=External fault, oc 6=Run enable 7=Preset speed 2 8= Motor pot. UP (cc) 9= Disable PID (Direct freq. reference) 10=Interlock 2
P2.1.18	DIN3 function	0	13		6		301	<ul style="list-style-type: none"> 0=Not used 1=Reverse 2=External fault, cc 3=External fault, oc 4=Fault reset 5=Run enable 6=Preset speed 1 7=Preset speed 2 8=DC-braking command 9=Motor pot. UP (cc) 10=Motor pot. DOWN (cc) 11=Disable PID (Direct freq. reference) 12=PID Keypad ref. 2 selection 13=Interlock 3
P2.1.19	Preset speed 1	0,00	Par. 2.1.2	Hz	10,00		105	
P2.1.20	Preset speed 2	0,00	Par. 2.1.2	Hz	50,00		106	
P2.1.21	Automatic restart	0	1		0		731	<ul style="list-style-type: none"> 0=Not used 1=Used
P2.1.22	Parameter conceal	0	1		1		115	<ul style="list-style-type: none"> 0=All parameters and menus visible 1=Only group P2.1 and menus M1 to H5 visible

Table 1- 4. Basic parameters B2.1

3.3 Input signals (Control keypad: Menu P2 → P2.2)

Code	Parameter	Min	Max	Unit	Default	Cust	ID	Note
P2.2.1	Expander board DIE1 function	0	12		7		368	0=Not used 1=Reverse 2=External fault, cc 3=External fault, oc 4=Fault reset 5=Run enable 6=Preset speed 1 7=Preset speed 2 8=DC-braking command 9=Motor pot. UP (cc) 10=Motor pot. DOWN (cc) 11=Disable PID (PID control selection) 12=PID Keypad ref. 2 selection
P2.2.2	Expander board DIE2 function	0	12		4		330	See above
P2.2.3	Expander board DIE3 function	0	12		11		369	See above
P2.2.4	DIN4 function (AI1)	0	12		2		499	Used if P2.2.6 = 0 See the selections above
P2.2.5	AI1 signal selection	0			10		377	10=AI1 (1=Local, 0=input 1) 11=AI2 (1=Local, 1=input 2) 20=Exp. AI1 (2=exp.board 0=input 1) 21=Exp AI2 (2=exp.board 1=input 2)
P2.2.6	AI1 signal range	1	4		3		379	0=Digital input 4 1=0mA – 20mA (MF4-->) 2=4mA – 20mA (MF4-->) 3=0V – 10V 4=2V – 10V Not used if AI2 Custom min > 0% or AI2 custom max. < 100% Note! See NXL User's manual, chapter 7.3.6: AI1 mode
P2.2.7	AI1 custom minimum setting	0,00	100,00	%	0,00		380	
P2.2.8	AI1 custom maximum setting	0,00	100,00	%	100,00		381	
P2.2.9	AI1 inversion	0	1		0		387	0=Not inverted 1=Inverted
P2.2.10	AI1 filter time	0,00	10,00	s	0,10		378	0=No filtering
P2.2.11	AI2 signal selection	0			11		388	As par. 2.2.5

P2.2.12	AI2 signal range	1	4		2		390	Not used if AI2 Custom min <> 0% or AI2 custom max. <> 100% 1=0—20 mA 2=4—20 mA 3=0V – 10V 4=2V – 10V
P2.2.13	AI2 custom minimum setting	0,00	100,00	%	0,00		391	
P2.2.14	AI2 custom maximum setting	0,00	100,00	%	100,00		392	
P2.2.15	AI2 inversion	0	1		0		398	0=Not inverted 1=Inverted
P2.2.16	AI2 filter time	0,00	10,00	s	0,10		389	0=No filtering
P2.2.17	Motor potentiometer frequency reference memory reset	0	2		1		367	0=No reset 1=Reset if stopped or powered down 2=Reset if powered down
P2.2.18	Reference scaling minimum value	0,00	P2.2.19		0,00		344	
P2.2.19	Reference scaling maximum value	P2.2.18	320,00		0,00		345	
P2.2.20	Keypad control reference selection	0	5		2		121	0=AI1 1=AI2 2=Keypad reference 3=Fieldbus reference (FBSpeedreference) 4=Motor potentiometer 5=PID controller
P2.2.21	Fieldbus control reference selection	0	5		3		122	See above

Table 1- 5. Input signals, I2.2

CP=control place
cc=closing contact
oc=opening contact

3.4 Output signals (Control keypad: Menu P2 → P2.3)

Code	Parameter	Min	Max	Unit	Default	Cust	ID	Note
P2.3.1	Relay output 1 function	0	19		3		313	0=Not used 1=Ready 2=Run 3=Fault 4=Fault inverted 5=FC overheat warning 6=Ext. fault or warning 7=Ref. fault or warning 8=Warning 9=Reversed 10=Preset speed 11=At speed 12=Mot. regulator active 13=OP freq. limit superv.1 14=Control place: IO 15=Thermistor fault/warning 16=Actual value supervision 17=Autochange 1 control 18=Autochange 2 control 19=Autochange 3 control
P2.3.2	Expander board relay output 1 function	0	16		2		314	As parameter 2.3.1
P2.3.3	Expander board relay output 2 function	0	16		3		317	As parameter 2.3.1
P2.3.4	Expander board digital output 1 function	0	16		1		312	As parameter 2.3.1
P2.3.5	Analogue output function	0	12		1		307	See par. 2.1.16
P2.3.6	Analogue output filter time	0,00	10,00	s	1,00		308	0=No filtering
P2.3.7	Analogue output inversion	0	1		0		309	0=Not inverted 1=Inverted
P2.3.8	Analogue output minimum	0	1		0		310	0=0 mA 1=4 mA
P2.3.9	Analogue output scale	10	1000	%	100		311	
P2.3.10	Expander board analogue output 1 function	0	12		0		472	As parameter 2.1.16
P2.3.11	Expander board analogue output 2 function	0	12		0		479	As parameter 2.1.16
P2.3.12	Output frequency limit 1 supervision	0	2		0		315	0=No limit 1=Low limit supervision 2=High limit supervision
P2.3.13	Output frequency limit 1; Supervised value	0,00	Par. 2.1.2	Hz	0,00		316	

Table 1- 6. Output signals, G2.3

3.5 Drive control parameters (Control keypad: Menu P2 → P2.4)

Code	Parameter	Min	Max	Unit	Default	Cust	ID	Note
P2.4.1	Ramp 1 shape	0,0	10,0	s	0,0		500	0=Linear >0=S-curve ramp time
P2.4.2	Brake chopper	0	3		0		504	0=Disabled 1=Used in Run state 3=Used in Run and Stop state
P2.4.3	DC braking current	$0,15 \times I_n$	$1,5 \times I_n$	A	Varies		507	
P2.4.4	DC braking time at stop	0,00	600,00	s	0,00		508	0=DC brake is off at stop
P2.4.5	Frequency to start DC braking during ramp stop	0,10	10,00	Hz	1,50		515	
P2.4.6	DC braking time at start	0,00	600,00	s	0,00		516	0=DC brake is off at start
P2.4.7	Flux brake	0	1		0		520	0=Off 1=On
P2.4.8	Flux braking current	0,0	Varies	A	0,0		519	

Table 1- 7. Drive control parameters, D2.4

3.6 Prohibit frequency parameters (Control keypad: Menu P2 → P2.5)

Code	Parameter	Min	Max	Unit	Default	Cust	ID	Note
P2.5.1	Prohibit frequency range 1 low limit	0,0	Par. 2.5.2	Hz	0,0		509	0=Not used
P2.5.2	Prohibit frequency range 1 high limit	0,0	Par. 2.1.2	Hz	0,0		510	0=Not used
P2.5.3	Prohibit frequencies acc./dec. ramp scaling	0,1	10,0	Times	1,0		518	Multiplier of the currently selected ramp time between prohibit frequency limits

Table 1- 8. Prohibit frequency parameters, G2.5

3.7 Motor control parameters (Control keypad: Menu P2 → P2.6)

Code	Parameter	Min	Max	Unit	Default	Cust	ID	Note
P2.6.1	Motor control mode	0	1		0		600	0=Frequency control 1=Speed control
P2.6.2	U/f ratio selection	0	3		0		108	0=Linear 1=Squared 2=Programmable 3=Linear with flux optim.
P2.6.3	Field weakening point	30,00	320,00	Hz	50,00		602	
P2.6.4	Voltage at field weakening point	10,00	200,00	%	100,00		603	n% x U _{nmot}
P2.6.5	U/f curve midpoint frequency	0,00	par. P2.6.3	Hz	50,00		604	
P2.6.6	U/f curve midpoint voltage	0,00	100,00	%	100,00		605	n% x U _{nmot} Parameter max. value = par. 2.6.4
P2.6.7	Output voltage at zero frequency	0,00	40,00	%	0,00		606	n% x U _{nmot}
P2.6.8	Switching frequency	1,0	16,0	kHz	6,0		601	Depends on kW
P2.6.9	Overvoltage controller	0	1		1		607	0=Not used 1=Used
P2.6.10	Undervoltage controller	0	1		1		608	0=Not used 1=Used

Table 1- 9. Motor control parameters, G2.6

3.8 Protections (Control keypad: Menu P2 → P2.7)

Code	Parameter	Min	Max	Unit	Default	Cust	ID	Note
P2.7.1	Response to 4mA reference fault	0	3		0		700	0=No response 1=Warning 2=Fault, stop acc. to 2.1.12 3=Fault, stop by coasting
P2.7.2	Response to external fault	0	3		2		701	0=No response 1=Warning 2=Fault, stop acc. to 2.1.12 3=Fault, stop by coasting
P2.7.3	Response to undervoltage fault	1	3		2		727	
P2.7.4	Output phase supervision	0	3		2		702	
P2.7.5	Earth fault protection	0	3		2		703	
P2.7.6	Thermal protection of the motor	0	3		2		704	
P2.7.7	Motor ambient temperature factor	-100,0	100,0	%	0,0		705	
P2.7.8	Motor cooling factor at zero speed	0,0	150,0	%	40,0		706	
P2.7.9	Motor thermal time constant	1	200	min	45		707	
P2.7.10	Motor duty cycle	0	100	%	100		708	
P2.7.11	Stall protection	0	3		1		709	As par. 2.7.1
P2.7.12	Stall current limit	0,1	$I_{n\text{motor}} \times 2$	A	$I_{n\text{motor}} \times 1.3$		710	
P2.7.13	Stall time limit	1,00	120,00	s	15,00		711	
P2.7.14	Stall frequency limit	1,0	P 2.1.2	Hz	25,0		712	
P2.7.15	Underload protection	0	3		0		713	As par. 2.7.1
P2.7.16	Underload curve at nominal frequency	10,0	150,0	%	50,0		714	
P2.7.17	Underload curve at zero frequency	5,0	150,0	%	10,0		715	
P2.7.18	Underload protection time limit	2,00	600,00	s	20,00		716	
P2.7.19	Response to thermistor fault	0	3		0		732	As par. 2.7.1
P2.7.20	Response to fieldbus fault	0	3		2		733	As par. 2.7.1
P2.7.21	Response to slot fault	0	3		2		734	As par. 2.7.1
P2.7.22	Actual value supervision	0	4		0		735	0=No response 1=Warning if below limit 2=Warning if above limit 3=Fault, if below limit 4=Fault, if above limit
P2.7.23	Actual value supervision limit	0,0	100,0	%	10,0		736	
P2.7.24	Actual value supervision delay	0	3600	s	5		737	

Table 1- 10. Protections, G2.7

3.9 Autorestart parameters (Control keypad: Menu P2 → P2.8)

Code	Parameter	Min	Max	Unit	Default	Cust	ID	Note
P2.8.1	Wait time	0,10	10,00	s	0,50		717	
P2.8.2	Trial time	0,00	60,00	s	30,00		718	
P2.8.3	Start function	0	2		0		719	0=Ramp 1=Flying start 2=According to par. 2.4.6

Table 1- 11. Autorestart parameters, G2.8

3.10 PID reference parameters (Control keypad: Menu P2 → P2.9)

Code	Parameter	Min	Max	Unit	Default	Cust	ID	Note
P2.9.1	PID activation	0	1		0		163	0=Not used 1=PID controller activated 2=Pump & fan control active, group P2.10 visible
P2.9.2	PID reference	0	3		2		332	0=AI1 1=AI2 2=Ref. from keypad (PID Ref 1) 3=Fieldbus reference (ProcessDataIN1)
P2.9.3	Actual value input	0	6		1		334	0=AI1 signal 1=AI2 signal 2=Fieldbus (ProcessDataIN2) 3=Motor torque 4=Motor speed 5=Motor current 6=Motor power
P2.9.4	PID controller gain	0,0	1000,0	%	100,0		118	
P2.9.5	PID controller I-time	0,00	320,00	s	10,00		119	
P2.9.6	PID controller D-time	0,00	10,00	s	0,00		132	
P2.9.7	Actual value 1 minimum scale	-1000,0	1000,0	%	0,00		336	0=No minimum scaling
P2.9.8	Actual value 1 maximum scale	-1000,0	1000,0	%	100,0		337	100=No maximum scaling
P2.9.9	Error value inversion	0	1		0		340	
P2.9.10	Sleep frequency	Par. 2.1.1	Par. 2.1.2	Hz	10,00		1016	
P2.9.11	Sleep delay	0	3600	s	30		1017	
P2.9.12	Wake up level	0,00	100,00	%	25,00		1018	
P2.9.13	Wake up function	0	1		0		1019	0=Wake-up at fall below wake-up level (2.9.12) 1=Wake-up at exceeded wake-up level (2.9.12)

Table 1- 12. PID reference parameters, G2.9

3.11 Pump & Fan control parameters (Control keypad: Menu P2 → P2.10)

NOTE! Group P2.10 is visible only if the value of par 2.9.1 is set to 2.

Code	Parameter	Min	Max	Unit	Default	Cust	ID	Note
P2.10.1	Number of auxiliary drives	0	3		1		1001	
P2.10.2	Start delay, auxiliary drives	0,0	300,0	s	4,0		1010	
P2.10.3	Stop delay, auxiliary drives	0,0	300,0	s	2,0		1011	
P2.10.4	Autochange	0	4		0		1027	0=Not used 1= Autochange with aux pumps 2= Autochange with Freq. conv & aux pumps 3= Autochange and interlocks (aux pumps) 4= Autochange and interlocks (Freq. conv & aux pumps) NOTE! If interlocks are used, DIN 1 is automatically the intelock for Autochange output 1. Interlocks for Autochange output 2 & 3 can be selected with par 2.1.17 & 2.1.18. INTERLOCK INPUTS ARE ALSO START COMMANDS FOR FREQUENCY CONVERTER! (If one of these interlock inputs is active --> first motor is started)
P2.10.5	Autochange interval	0,0	3000,0	h	48,0		1029	0,0=TEST=40 s Elapsed time for autochange
P2.10.6	Autochange; Maximum number of auxiliary drives	0	3		1		1030	Autochange level for auxiliary drives
P2.10.7	Autochange frequency limit	0,00	par. 2.1.2	Hz	25,00		1031	Autochange frequency level for variable speed drive

Table 1- 13. Pump and fan control parameters

3.12 Keypad control (Control keypad: Menu K3)

The parameters for the selection of control place and direction on the keypad are listed below. See the Keypad control menu in the NXL User's Manual.

Code	Parameter	Min	Max	Unit	Default	Cust	ID	Note
P3.1	Control place	1	3		1		125	1 = I/O terminal 2 = Keypad 3 = Fieldbus
R3.2	Keypad reference	Par. 2.1.1	Par. 2.1.2	Hz				
P3.3	Direction (on keypad)	0	1		0		123	0 = Forward 1 = Reverse
R3.4	Stop button	0	1		1		114	0=Limited function of Stop button 1=Stop button always enabled
R3.5	PID reference	0,00	100,00	%	0,00			
R3.6	PID reference 2	0,00	100,00	%	0,00			Selected with digital inputs

Table 1- 14. Keypad control parameters, M3

3.13 System menu (Control keypad: Menu S6)

For parameters and functions related to the general use of the frequency converter, such as customised parameter sets or information about the hardware and software, see Chapter 7.3.6 in the NXL User's Manual.

3.14 Expander boards (Control keypad: Menu E7)

The **E7** menu shows the expander boards attached to the control board and board-related information. For more information, see Chapter 7.3.7 in the NXL User's Manual.

4. Description of parameters

4.1 BASIC PARAMETERS

2.1.1, 2.1.2 *Minimum/maximum frequency*

Defines the frequency limits of the frequency converter.

The maximum value for parameters 2.1.1 and 2.1.2 is 320 Hz.

The software will automatically check the values of parameters 2.1.19, 2.1.20, 2.3.13, 2.5.1, 2.5.2 and 2.6.5.

2.1.3, 2.1.4 *Acceleration time 1, deceleration time 1*

These limits correspond to the time required for the output frequency to accelerate from the zero frequency to the set maximum frequency (par. 2.1.2).

2.1.5 *Current limit*

This parameter determines the maximum motor current from the frequency converter. To avoid motor overload, set this parameter according to the rated current of the motor. The current limit is equal to the rated converter current (I_L) by default.

2.1.6 *Nominal voltage of the motor*

Find this value U_n on the rating plate of the motor. This parameter sets the voltage at the field weakening point (parameter 2.6.4) to $100\% \times U_{n\text{motor}}$.

2.1.7 *Nominal frequency of the motor*

Find this value f_n on the rating plate of the motor. This parameter sets the field weakening point (parameter 2.6.3) to the same value.

2.1.8 *Nominal speed of the motor*

Find this value n_n on the rating plate of the motor.

2.1.9 *Nominal current of the motor*

Find this value I_n on the rating plate of the motor.

2.1.10 *Motor cos phi*

Find this value "cos phi" on the rating plate of the motor.

2.1.11 Start function

Ramp:

- 0** The frequency converter starts from 0 Hz and accelerates to maximum frequency within the set acceleration time. (Load inertia or starting friction may cause prolonged acceleration times).

Flying start:

- 1** The frequency converter is able to start into a running motor by applying a small torque to motor and searching for the frequency corresponding to the speed the motor is running at. The searching starts from the maximum frequency towards the actual frequency until the correct value is detected. Thereafter, the output frequency will be increased/decreased to the set reference value according to the set acceleration/deceleration parameters.

Use this mode if the motor is coasting when the start command is given. With the flying start, it is possible to ride through short mains voltage interruptions.

2.1.12 Stop function

Coasting:

- 0** The motor coasts to a halt without control from the frequency converter after the Stop command.

Ramp:

- 1** After the Stop command, the speed of the motor is decelerated according to the set deceleration parameters.
If the regenerated energy is high it may be necessary to use an external braking resistor for faster deceleration.

2.1.15 U/f optimisation

0 Not used

1 **Automatic torque boost**
The voltage to the motor changes automatically which makes the motor produce sufficient torque to start and run at low frequencies. The voltage increase depends on the motor type and power. Automatic torque boost can be used in applications where starting torque due to starting friction is high, e.g. in conveyors.

NOTE! *In high torque – low speed applications – it is likely that the motor will overheat. If the motor has to run a prolonged time under these conditions, special attention must be paid to cooling the motor. Use external cooling for the motor if the temperature tends to rise too high.*

2.1.14 I/O Reference selection

Defines the selected frequency reference source when the drive is controlled from the I/O terminal.

- 0** AI1 reference (terminals 2 and 3, e.g. potentiometer)
- 1** AI2 reference (terminals 5 and 6, e.g. transducer)
- 2** Keypad reference (parameter 3.2)
- 3** Reference from Fieldbus (FBSpeedReference)
- 4** Motor potentiometer reference

2.1.15 AI2 (I_{in}) signal range

- 1** Signal range 0...20 mA
- 2** Signal range 4...20 mA

Note! The selections have no effect if par. 2.2.12 > 0%, or par. 2.2.13 < 100%.

2.1.16 Analogue output function

This parameter selects the desired function for the analogue output signal. See the table on page 5 for the parameter values.

2.1.17 *DIN2 function*

This parameter has 9 selections. If digital input DIN2 need not be used, set the parameter value to 0.

- 1 Start reverse
- 2 Reverse
- 3 Stop pulse
- 4 External fault
Contact closed: Fault is displayed and motor stopped when the input is active
- 5 External fault
Contact open: Fault is displayed and motor stopped when the input is not active
- 6 Run enable
Contact open: Start of motor disabled
Contact closed: Start of motor enabled
Coast stop if dropped during RUN
- 7 Preset speed 2
- 8 Motor potentiometer UP
Contact closed: Reference increases until the contact is opened.
- 9 Disable the PID-controller (Direct frequency reference)
- 10 Interlock 2 (can only be selected, when pump and fan control is active, P2.9.1=2)

2.1.18 *DIN3 function*

This parameter has 12 selections. If digital input DIN3 need not be used, set the parameter value to 0.

- 1 Reverse
Contact open: Forward
Contact closed: Reverse
- 2 External fault
Contact closed: Fault is displayed and motor stopped when the input is active
- 3 External fault
Contact open: Fault is displayed and motor stopped when the input is not active
- 4 Fault reset
Contact closed: All faults reset
- 5 Run enable
Contact open: Start of motor disabled
Contact closed: Start of motor enabled
Coast stop if dropped during RUN
- 6 Preset speed 1
- 7 Preset speed 2
- 8 DC braking command
Contact closed: In Stop mode, the DC braking operates until the contact is opened. See par. 2.4.3 – 2.4.6
- 9 Motor potentiometer UP
Contact closed: Reference increases until the contact is opened.
- 10 Motor potentiometer DOWN.
Contact closed: Reference decreases until the contact is opened
- 11 Disable the PID-controller (Direct frequency reference)
- 12 PID Keypad reference 2 selection
- 13 Interlock 3 (can only be selected, when pump and fan control is active, P2.9.1=2)

2.1.19 Preset speed 1**2.1.20 Preset speed 2**

Parameter values are automatically limited between the minimum and maximum frequencies. (par. 2.1.1 and 2.1.2)

2.1.21 Automatic restart function

The automatic restart is taken into use with this parameter

0 = Disabled

1 = Enabled (3 automatic restarts, see par. 2.8.1 – 2.8.3)

2.1.22 Parameter conceal

With this parameter you can hide all other parameter groups except the basic parameter group (B2.1).

Note! The factory default of this parameter is **1**, i.e. all parameter groups except b2.1 have been hidden. The other parameter groups cannot be browsed or edited before the value of this parameter is set to **0**.

0 = Disabled (all parameter groups can be browsed with the keypad)

1 = Enabled (only the basic parameters, B2.1, can be browsed with the keypad)

4.2 INPUT SIGNALS

2.2.1 Expander board DIE1 function

This parameter has 12 selections. If the expander board digital input DIN1 need not be used, set the parameter value to 0.

See parameter 2.1.18 for the selections.

2.2.2 Expander board DIE2 function

The selections are the same as in parameter 2.2.1.

2.2.3 Expander board DIE3 function

The selections are the same as in parameter 2.2.1.

2.2.4 DIN4 Function

If the value of par. 2.2.6 is set to 0, AI1 functions as digital input 4. The selections are the same as in parameter 2.2.1.

NOTE! If you program the analogue input as DIN4 check that the jumper selections of X4 are correct (see figure below).

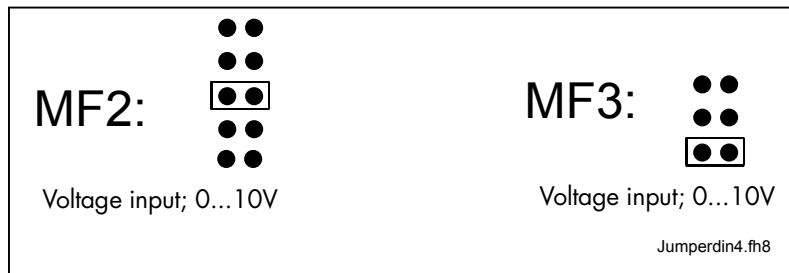

Figure 1- 1. Jumper selections of X4 when AI1 functions as DIN4

2.2.5 AI1 signal selection

Connect the AI1 signal to the analogue input of your choice with this parameter.

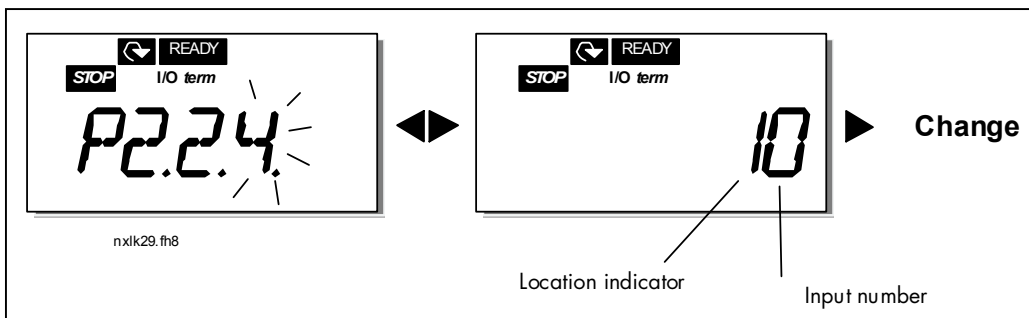

Figure 1- 2. AI1 signal selection

The value of this parameter is formed of the *board indicator* and the *respective input terminal number*. See Figure 1- 2.

Board indicator 1	= Local inputs
Board indicator 2	= Expander board inputs
Input number 0	= Input 1
Input number 1	= Input 2
Input number 2	= Input 3
⋮	
Input number 9	= Input 10

Example:

If you set the value of this parameter to **10**, you have selected the local input **1** for the AI1 signal. Again, if the value is set to **21**, the expander board input **2** has been selected for the AI1 signal.

If you want to use the values of analogue input signal for e.g. testing purposes only, you can set the parameter value to **0 - 9**. In this case, value **0** corresponds to **0%**, value **1** corresponds to **20%** and any value between **2** and **9** corresponds to **100%**.

2.2.6 AI1 signal range

With this parameter you can select the AI1 signal range.

- 0** = DIN 4
- 1** = Signal range 0...20mA (only for sizes MF4 and bigger)
- 2** = Signal range 4...20mA (only for sizes MF4 and bigger)
- 3** = Signal range 0...10V
- 4** = Signal range 2...10V

Note! The selections have no effect if par. 2.2.7 > 0%, or par. 2.2.8 < 100%.

If the value of par. 2.2.6 is set to **0**, AI1 functions as digital input 4.
See par. 2.2.4

2.2.7 AI1 custom setting minimum

2.2.8 AI1 custom setting maximum

Set the custom minimum and maximum levels for the AI1 signal within 0...10V.

2.2.9 *AI1 signal inversion*

By setting the parameter value to **1** the AI1 signal inversion takes place.

2.2.10 *AI1 signal filter time*

This parameter, given a value greater than 0, activates the function that filters out disturbances from the incoming analogue U_{in} signal. Long filtering time makes the regulation response slower. See Figure 1- 3

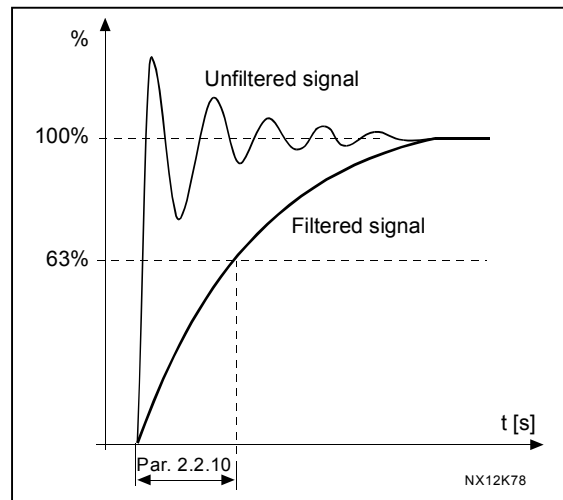

Figure 1- 3. AI1 signal filtering

2.2.11 *AI2 signal selection*

Connect the AI2 signal to the analogue input of your choice with this parameter. See par. 2.2.5 for the value setting procedure.

2.2.12 *AI2 signal range*

- 0 Signal range 0...20 mA
- 1 Signal range 4...20 mA

Note! The selections have no effect if par. 2.2.13 > 0%, or par. 2.2.14 < 100%.

2.2.13 *AI2 custom minimum*

2.2.14 *AI2 custom maximum*

These parameters allow you to scale the input current signal between 0 and 20 mA. Cf. parameters 2.2.7 and 2.2.8.

2.2.15 *Analogue input AI2 signal inversion*

See corresponding parameter 2.2.9.

2.2.16 Analogue input AI2 signal filter time

See corresponding parameter 2.2.10.

2.2.17 Motor potentiometer memory reset (Frequency reference)

0 = No reset

1 = Memory reset in stop and powerdown

2 = Memory reset in powerdown

2.2.18 Reference scaling minimum value**2.2.19 Reference scaling maximum value**

You can choose a scaling range for the frequency reference between the Minimum and Maximum frequency. If no scaling is desired set the parameter value to 0.

In the figures below, voltage input AI1 with signal range 0...10V is selected for reference.

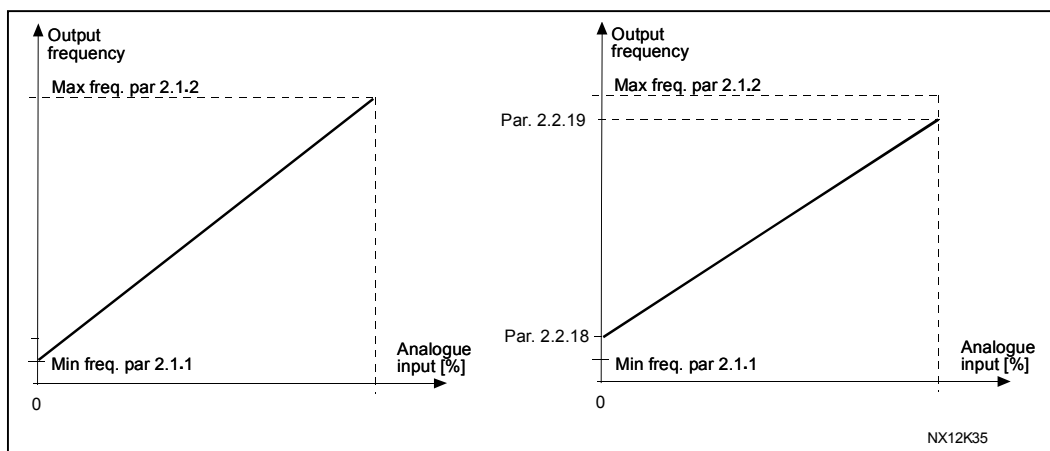

Figure 1- 4. Left: Par. 2.1.18=0 (No reference scaling) Right: Reference scaling

2.2.20 Keypad frequency reference selection

Defines the selected reference source when the drive is controlled from the keypad

- 0 AI1 reference (by default AI1, terminals 2 and 3, e.g. potentiometer)
- 1 AI2 reference (by default AI2, terminals 5 and 6, e.g. transducer)
- 2 Keypad reference (parameter 3.2)
- 3 Reference from Fieldbus (FBSpeedReference)
- 4 Motor potentiometer reference
- 5 PID-controller reference

2.2.21 Fieldbus frequency reference selection

Defines the selected reference source when the drive is controlled from the fieldbus. For the parameter values, see par. 2.2.20.

4.3 OUTPUT SIGNALS

- 2.3.1 **Relay output 1 function**
- 2.3.2 **Expander board relay output 1 function**
- 2.3.3 **Expander board relay output 2 function**
- 2.3.4 **Expander board digital output 1 function**

Setting value	Signal content
0 = Not used	Out of operation
	Relay output RO1 and expander board programmable relays (RO1, RO2) are activated when:
1 = Ready	The frequency converter is ready to operate
2 = Run	The frequency converter operates (motor is running)
3 = Fault	A fault trip has occurred
4 = Fault inverted	A fault trip <u>not</u> occurred
5 = Frequency converter overheat warning	The heat-sink temperature exceeds +70°C
6 = External fault or warning	Fault or warning depending on par. 2.7.2
7 = Reference fault or warning	Fault or warning depending on par. 2.7.1 - if analogue reference is 4—20 mA and signal is <4mA
8 = Warning	Always if a warning exists
9 = Reversed	The reverse command has been selected
10 = Preset speed	A preset speed has been selected
11 = At speed	The output frequency has reached the set reference
12 = Motor regulator activated	Overvoltage or overcurrent regulator was activated
13 = Output frequency limit 1 supervision	The output frequency goes outside the set supervision low limit/high limit (see parameters 2.3.12 and 2.3.13 below)
14 = Control from I/O terminals	Selected control place (Menu K3 ; par. 3.1) is "I/O terminal"
15 = Thermistor fault or warning	The thermistor input of option board indicates overtemperature. Fault or warning depending on parameter 2.7.19.
16 = Actual value supervision active	Parameters 2.7.22 – 2.7.24
17 = Autochange 1 control	Pump 1 control, parameters 2.10.1 – 2.10.7
18 = Autochange 2 control	Pump 2 control, parameters 2.10.1 – 2.10.7
19 = Autochange 3 control	Pump 3 control, parameters 2.10.1 – 2.10.7

Table 1- 15. Output signals via RO1 and expander board RO1, RO2 and DO1.

2.3.5 Analogue output function

This parameter selects the desired function for the analogue output signal. See the table on page 5 for the parameter values.

2.3.6 Analogue output filter time

Defines the filtering time of the analogue output signal.

If you set value **0** for this parameter, no filtering takes place.

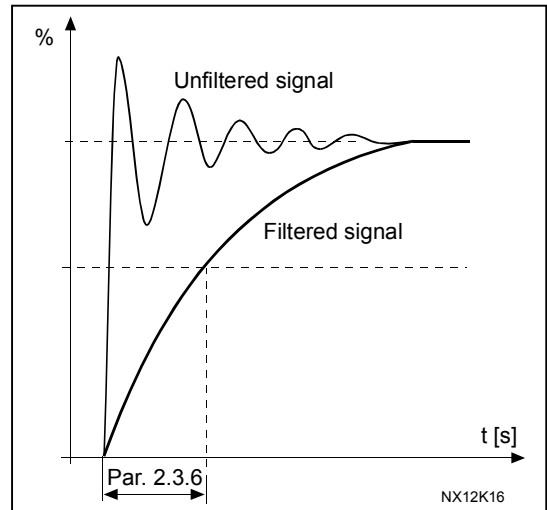

Figure 1- 5. Analogue output filtering

2.3.7 Analogue output invert

Inverts the analogue output signal:

Maximum output signal = 0 %

Minimum output signal = Maximum set value (parameter 2.3.9)

0 Not inverted

1 Inverted

See parameter 2.3.9 below.

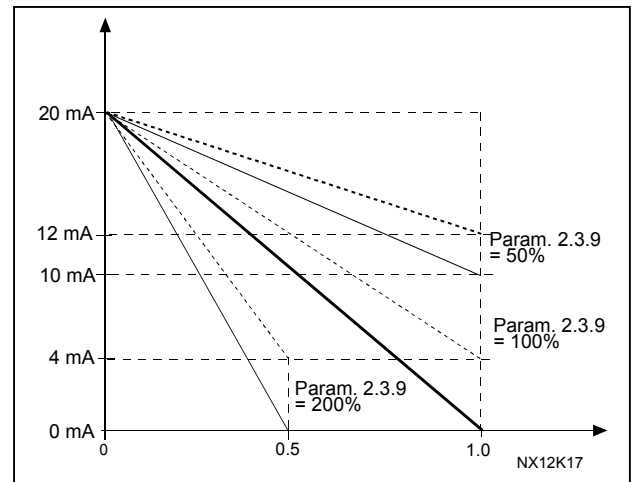

Figure 1- 6. Analogue output invert

2.3.8 Analogue output minimum

Sets the signal minimum to either 0 mA or 4 mA (living zero). Note the difference in the analogue output scaling in parameter 2.3.9.

2.3.9 Analogue output scale

Scaling factor for the analogue output.

Signal	Max. value of the signal
Output frequency	100% x f_{max}
Motor speed	100% x Motor nom. speed
Output current	100% x I_{nMotor}
Motor torque	100% x T_{nMotor}
Motor power	100% x P_{nMotor}
Motor voltage	100% x U_{nMotor}
DC-link voltage	1000 V
PI-ref. value	100% x ref. value max.
PI act. value 1	100% x actual value max.
PI error value	100% x error value max.
PI output	100% x output max.

Table 1- 16. Analogue output scaling

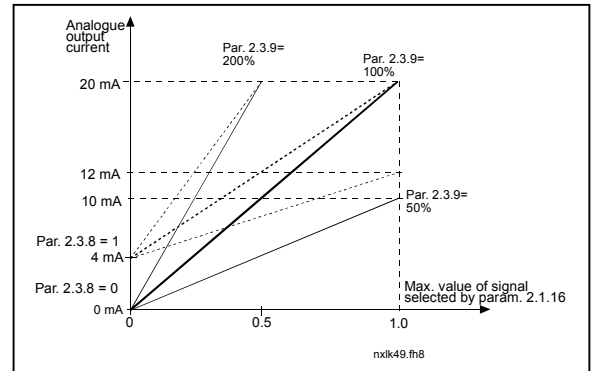

Figure 1- 7. Analogue output scaling

2.3.10 Expander board analogue output 1 function

2.3.11 Expander board analogue output 2 function

These parameters select the desired functions for the expander board analogue output signals. See par. 2.1.16 for the parameter values.

2.3.12 Output frequency limit 1 supervision function

- 0 No supervision
- 1 Low limit supervision
- 2 High limit supervision

If the output frequency goes under/over the set limit (par. 2.3.13) this function generates a warning message via the relay outputs depending on the settings of parameters 2.3.1 – 2.3.4.

2.3.13 Output frequency limit 1 supervised value

Selects the frequency value supervised by parameter 2.3.12.

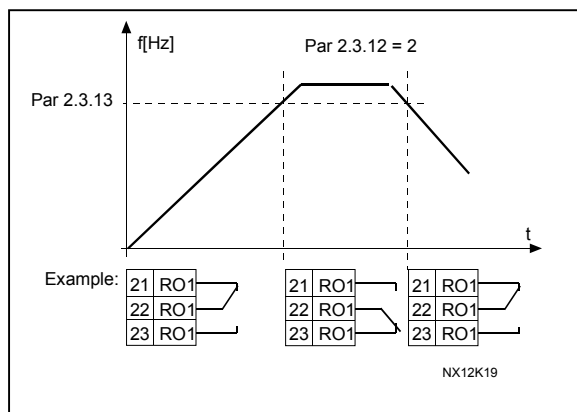

Figure 1- 8. Output frequency supervision

4.4 DRIVE CONTROL

2.4.1 Acceleration/Deceleration ramp 1 shape

The start and end of the acceleration and deceleration ramp can be smoothed with this parameter. Setting value 0 gives a linear ramp shape which causes acceleration and deceleration to act immediately to the changes in the reference signal. Setting value 0.1... 10 seconds for this parameter produces an S-shaped acceleration/deceleration. The acceleration time is determined with parameters 2.1.3/2.1.4

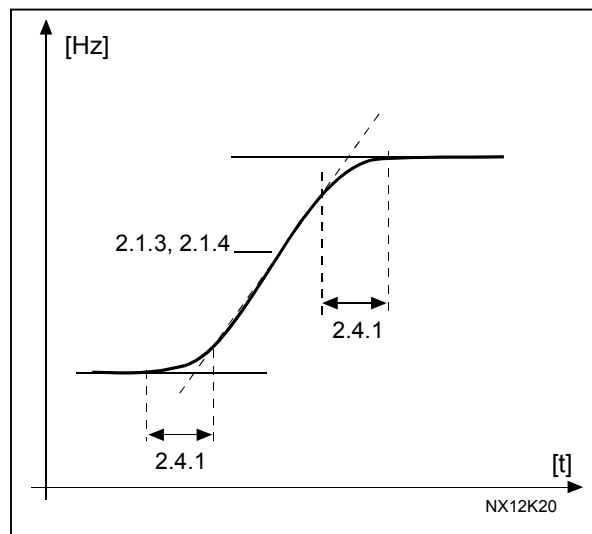

Figure 1- 9. Acceleration/Deceleration (S-shaped)

2.4.2 Brake chopper

Note! An internal brake chopper is installed in all other sizes but MF2

- 0 No brake chopper used
- 1 Brake chopper used in Run state
- 3 Used in Run and Stop state

When the frequency converter is decelerating the motor, the inertia of the motor and the load are fed into an external brake resistor. This enables the frequency converter to decelerate the load with a torque equal to that of acceleration (provided that the correct brake resistor has been selected). See separate Brake resistor installation manual.

2.4.3 DC-braking current

Defines the current injected into the motor during DC-braking.

2.4.4 DC-braking time at stop

Determines if braking is ON or OFF and the braking time of the DC-brake when the motor is stopping. The function of the DC-brake depends on the stop function, parameter 2.1.12.

- 0 DC-brake is not used
- >0 DC-brake is in use and its function depends on the Stop function, (par. 2.1.12). The DC-braking time is determined with this parameter

Par. 2.1.12 = 0 (Stop function = Coasting):

After the stop command, the motor coasts to a stop without control from the frequency converter.

With the DC injection, the motor can be electrically stopped in the shortest possible time, without using an optional external braking resistor.

The braking time is scaled by the frequency when the DC-braking starts. If the frequency is greater than the nominal frequency of the motor, the set value of parameter 2.4.4 determines the braking time. When the frequency is $\leq 10\%$ of the nominal, the braking time is 10% of the set value of parameter 2.4.4.

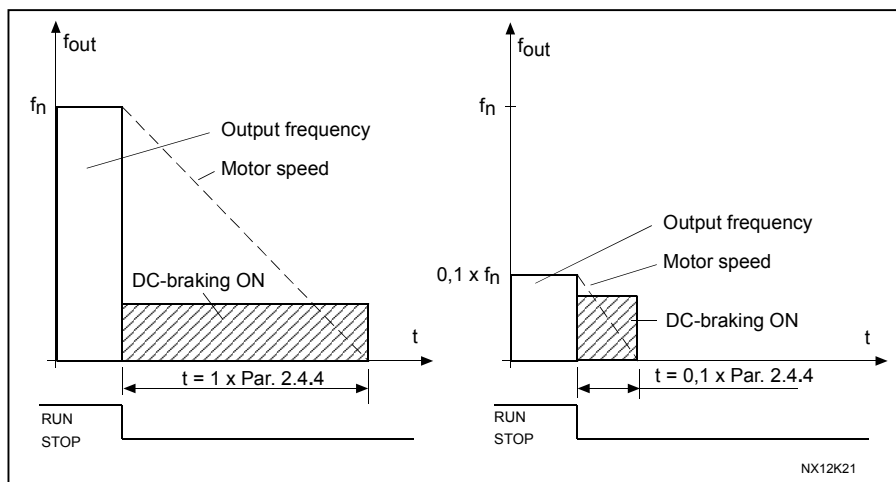

Figure 1- 10. DC-braking time when Stop mode = Coasting.

Par. 2.1.12 = 1 (Stop function = Ramp):

After the Stop command, the speed of the motor is reduced according to the set deceleration parameters, as fast as possible, to the speed defined with parameter 2.4.5, where the DC-braking starts.

The braking time is defined with parameter 2.4.4. If high inertia exists, it is recommended to use an external braking resistor for faster deceleration. See Figure 1- 11.

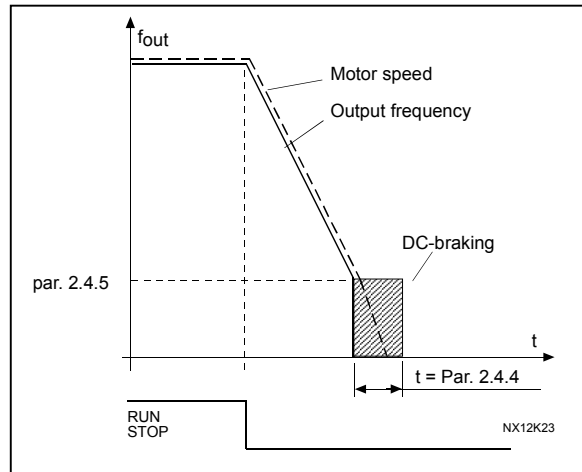

Figure 1- 11. DC-braking time when Stop mode = Ramp

2.4.5 DC-braking frequency in ramp stop

The output frequency at which the DC-braking is applied. See Figure 1- 11.

2.4.6 DC-braking time at start

DC-brake is activated when the start command is given. This parameter defines the time before the brake is released. After the brake is released, the output frequency increases according to the set start function by parameter 2.1.11. See Figure 1- 12.

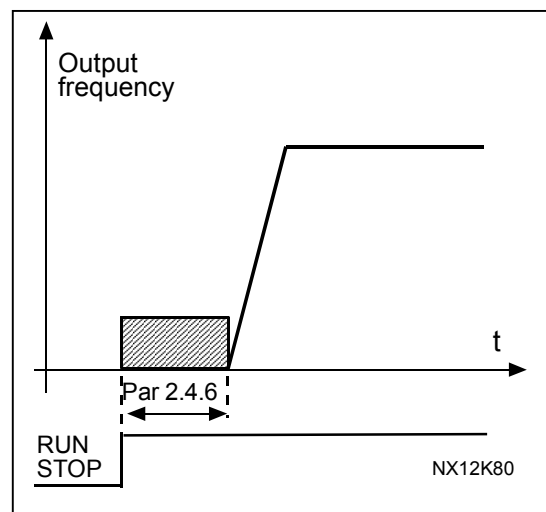

Figure 1- 12. DC braking time at start

2.4.7 Flux brake

The flux braking can be set ON or OFF.

0 = Flux braking OFF

1 = Flux braking ON

2.4.8 Flux braking current

Defines the flux braking current value. It can be set between $0.3 \times I_H$ (approximately) and the Current limit.

4.5 PROHIBIT FREQUENCIES

- 2.5.1 *Prohibit frequency area 1; Low limit*
- 2.5.2 *Prohibit frequency area 1; High limit*

In some systems it may be necessary to avoid certain frequencies because of mechanical resonance problems. With these parameters it is possible to set a limit for the "skip frequency" region. See Figure 1- 13.

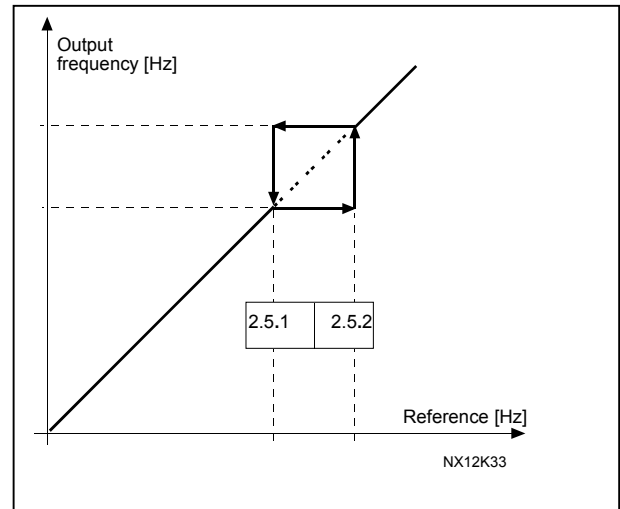

Figure 1- 13. Prohibit frequency area setting.

- 2.5.3 *Acceleration/deceleration ramp speed scaling ratio between prohibit frequency limits*

Defines the acceleration/deceleration time when the output frequency is between the selected prohibit frequency range limits (parameters 2.5.1 and 2.5.2). The ramping time (selected acceleration/ deceleration time 1 or 2) is multiplied with this factor. E.g. value 0.1 makes the acceleration time 10 times shorter than outside the prohibit frequency range limits.

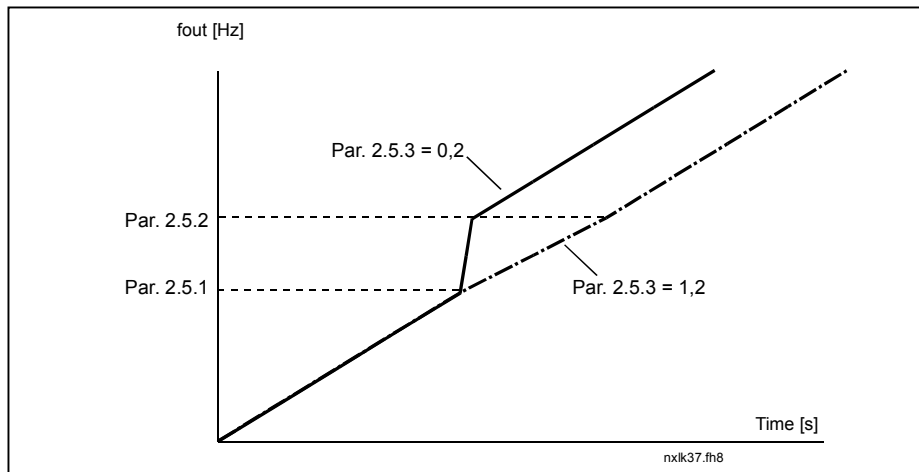

Figure 1- 14. Ramp time scaling between prohibit frequencies

4.6 MOTOR CONTROL

2.6.1 Motor control mode

- 0 Frequency control: The I/O terminal and keypad references are frequency references and the frequency converter controls the output frequency (output frequency resolution = 0.01 Hz)
- 1 Speed control: The I/O terminal and keypad references are speed references and the frequency converter controls the motor speed (accuracy $\pm 0,5\%$).

2.6.2 U/f ratio selection

Linear: The voltage of the motor changes linearly with the frequency in the constant flux area from 0 Hz to the field weakening point where the nominal voltage is supplied to the motor. Linear U/f ratio should be used in constant torque applications. See Figure 1- 15.

This default setting should be used if there is no special need for another setting.

Squared: The voltage of the motor changes following a squared curve form with the frequency in the area from 0 Hz to the field weakening point where the nominal voltage is also supplied to the motor. The motor runs under magnetised below the field weakening point and produces less torque and electromechanical noise. Squared U/f ratio can be used in applications where torque demand of the load is proportional to the square of the speed, e.g in centrifugal fans and pumps.

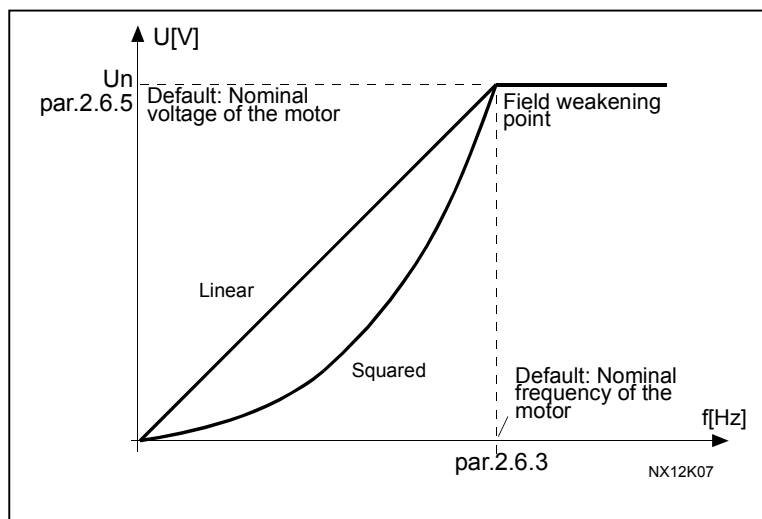

Figure 1- 15. Linear and squared change of motor voltage

Programmable U/f curve:

- 2** The U/f curve can be programmed with three different points. Programmable U/f curve can be used if the other settings do not satisfy the needs of the application.

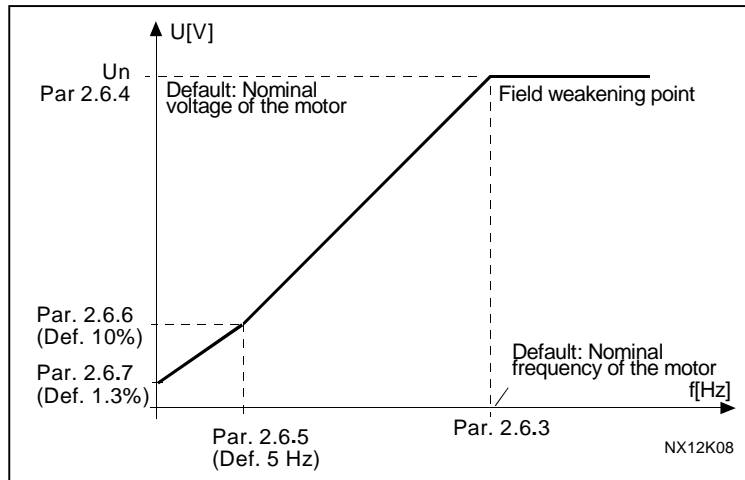

Figure 1- 16. Programmable U/f curve

Linear with flux optimisation:

- 3** The frequency converter starts to search for the minimum motor current and in order to save energy, lower the disturbance level and the noise. Can be used in applications with constant motor load, such as fans, pumps etc.

2.6.3 **Field weakening point**

The field weakening point is the output frequency at which the output voltage reaches the set maximum value.

2.6.4 **Voltage at field weakening point**

Above the frequency at the field weakening point, the output voltage remains at the set maximum value. Below the frequency at the field weakening point, the output voltage depends on the setting of the U/f curve parameters. See parameters 2.1.13, 2.6.2, 2.6.5, 2.6.6 and 2.6.7 and Figure 1- 16.

When the parameters 2.1.6 and 2.1.7 (nominal voltage and nominal frequency of the motor) are set, the parameters 2.6.3 and 2.6.4 are automatically given the corresponding values. If you need different values for the field weakening point and the maximum output voltage, change these parameters **after** setting the parameters 2.1.6 and 2.1.7.

2.6.5 **U/f curve, middle point frequency**

If the programmable U/f curve has been selected with parameter 2.6.2 this parameter defines the middle point frequency of the curve. See Figure 1- 16.

2.6.6 *U/f curve, middle point voltage*

If the programmable U/f curve has been selected with the parameter 2.6.2 this parameter defines the middle point voltage of the curve. See Figure 1- 16.

2.6.7 *Output voltage at zero frequency*

This parameter defines the zero frequency voltage of the curve. See Figure 1- 16.

2.6.8 *Switching frequency*

Motor noise can be minimised using a high switching frequency. Increasing the switching frequency reduces the capacity of the frequency converter unit.

Switching frequency for NXL: 1...16 kHz

2.6.9 *Overvoltage controller***2.6.10** *Undervoltage controller*

These parameters allow the under-/overvoltage controllers to be switched out of operation. This may be useful, for example, if the mains supply voltage varies more than -15% to +10% and the application will not tolerate this over-/undervoltage. This regulator controls the output frequency taking the supply fluctuations into account.

Note: Over-/undervoltage trips may occur when controllers are switched out of operation.

0 Controller switched off

1 Controller switched on

4.7 PROTECTIONS

2.7.1 *Response to 4mA reference fault*

- 0 = No response
- 1 = Warning
- 2 = Fault, stop mode after fault according to parameter 2.1.12
- 3 = Fault, stop mode after fault always by coasting

A warning or a fault action and message is generated if the 4...20 mA reference signal is used and the signal falls below 3.5 mA for 5 seconds or below 0.5 mA for 0.5 seconds. The information can also be programmed into relay outputs.

2.7.2 *Response to external fault*

- 0 = No response
- 1 = Warning
- 2 = Fault, stop mode after fault according to parameter 2.1.12
- 3 = Fault, stop mode after fault always by coasting

A warning or a fault action and message is generated from the external fault signal in the programmable digital inputs. The information can also be programmed into relay outputs.

2.7.3 *Response to undervoltage fault*

- 1 = Warning
- 2 = Fault, stop mode after fault according to parameter 2.1.12
- 3 = Fault, stop mode after fault always by coasting

For the undervoltage limits see NXL, User's Manual, Table 4-3.

Note: This protection can not be inactivated.

2.7.4 *Output phase supervision*

- 0 = No response
- 1 = Warning
- 2 = Fault, stop mode after fault according to parameter 2.1.12
- 3 = Fault, stop mode after fault always by coasting

Output phase supervision of the motor ensures that the motor phases have an approximately equal current.

2.7.5 *Earth fault protection*

- 0 = No response
- 1 = Warning
- 2 = Fault, stop mode after fault according to parameter 2.1.12
- 3 = Fault, stop mode after fault always by coasting

Earth fault protection ensures that the sum of the motor phase currents is zero. The overcurrent protection is always working and protects the frequency converter from earth faults with high currents.

Parameters 2.7.6—2.7.10, Motor thermal protection: General

The motor thermal protection is to protect the motor from overheating. The NXL drive is capable of supplying higher than nominal current to the motor. If the load requires this high current there is a risk that the motor will be thermally overloaded. This is the case especially at low frequencies. At low frequencies the cooling effect of the motor is reduced as well as its capacity. If the motor is equipped with an external fan the load reduction at low speeds is small.

The motor thermal protection is based on a calculated model and it uses the output current of the drive to determine the load on the motor.

The motor thermal protection can be adjusted with parameters. The thermal current I_T specifies the load current above which the motor is overloaded. This current limit is a function of the output frequency.



CAUTION! *The calculated model does not protect the motor if the airflow to the motor is reduced by blocked air intake grill.*

2.7.6 *Motor thermal protection*

- 0 = No response
- 1 = Warning
- 2 = Fault, stop mode after fault according to parameter 2.1.12
- 3 = Fault, stop mode after fault always by coasting

If tripping is selected the drive will stop and activate the fault stage. Deactivating the protection, i.e. setting parameter to 0, will reset the thermal model of the motor to 0%.

2.7.7 *Motor thermal protection: Motor ambient temperature factor*

When the motor ambient temperature must be taken into consideration, it is recommended to set a value for this parameter. The value of the factor can be set between -100.0% and 100.0% where -100.0% corresponds to 0°C and 100.0% to the maximum running ambient temperature of the motor. Setting this parameter value to 0% assumes that the ambient temperature is the same as the temperature of the heatsink at power-on.

2.7.8 Motor thermal protection: Cooling factor at zero speed

The cooling power can be set between 0—150.0% x cooling power at nominal frequency. See Figure 1-17.

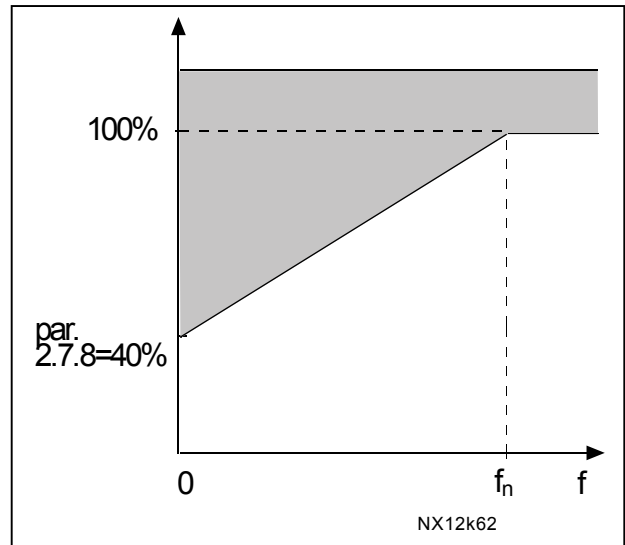

Figure 1- 17. Motor cooling power

2.7.9 Motor thermal protection: Time constant

This time can be set between 1 and 200 minutes.

This is the thermal time constant of the motor. The bigger the motor, the bigger the time constant. The time constant is the time within which the calculated thermal model has reached 63% of its final value.

The motor thermal time is specific to the motor design and it varies between different motor manufacturers.

If the motor's t_6 -time (t_6 is the time in seconds the motor can safely operate at six times the rated current) is known (given by the motor manufacturer) the time constant parameter can be set basing on it. As a rule of thumb, the motor thermal time constant in minutes equals to $2 \times t_6$. If the drive is in stop state the time constant is internally increased to three times the set parameter value. The cooling in the stop state is based on convection and the time constant is increased. See also Figure 1- 18.

Note: If the nominal speed (par. 2.1.8) or the nominal current (par. 2.1.9) of the motor are changed this parameter is automatically set to the default value (45).

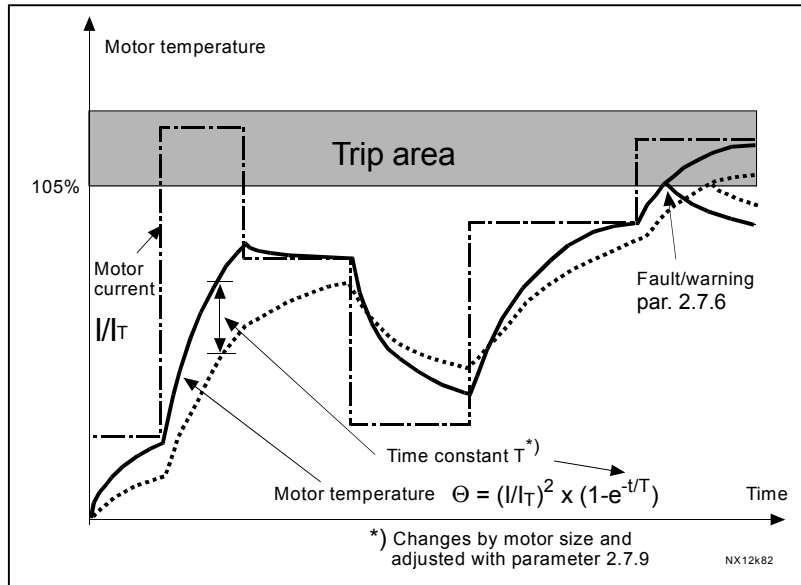

Figure 1- 18. Motor temperature calculation

2.7.10 Motor thermal protection: Motor duty cycle

Defines how much of the nominal motor load is applied.
The value can be set to 0%...100%.

Parameter 2.7.11, Stall protection:

General

The motor stall protection protects the motor from short time overload situations such as one caused by a stalled shaft. The reaction time of the stall protection can be set shorter than that of motor thermal protection. The stall state is defined with two parameters, 2.7.12 (Stall current) and 2.7.13 (Stall frequency). If the current is higher than the set limit and output frequency is lower than the set limit, the stall state is true. There is actually no real indication of the shaft rotation. Stall protection is a type of overcurrent protection.

2.7.11 Stall protection

- 0 = No response
- 1 = Warning
- 2 = Fault, stop mode after fault according to parameter 2.1.12
- 3 = Fault, stop mode after fault always by coasting

Setting the parameter to 0 will deactivate the protection and reset the stall time counter.

2.7.12 Stall current limit

The current can be set to $0.0 \dots I_{nMotor} * 2$. For a stall stage to occur, the current must have exceeded this limit. See Figure 1- 20. The software does not allow entering a greater value than $I_{nMotor} * 2$. If the parameter 2.1.9 Nominal current of motor is changed, this parameter is automatically restored to the default value ($I_{nMotor} * 1.3$).

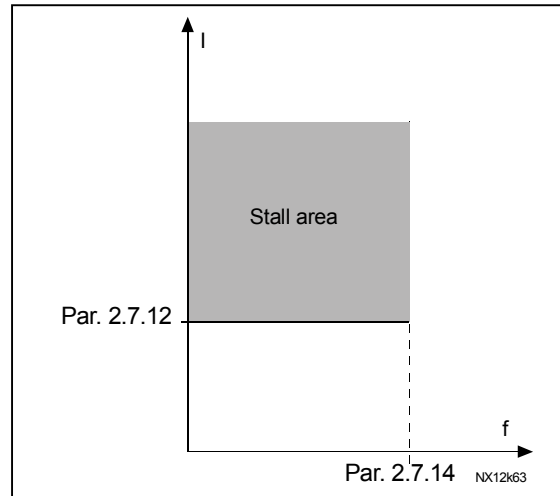

Figure 1- 19. Stall characteristics settings

2.7.13 Stall time

This time can be set between 1.0 and 120.0s. This is the maximum time allowed for a stall event detection. The stall time is counted by an internal up/down counter. If the stall time counter value goes above this limit the protection will cause a trip (see Figure 1- 20)

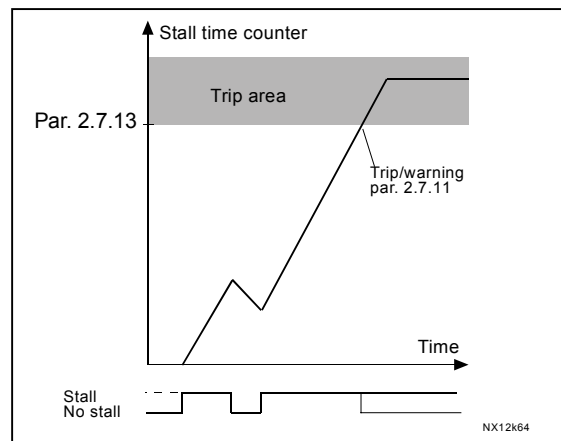

Figure 1- 20. Stall time count

2.7.14 Maximum stall frequency

The frequency can be set between $1-f_{max}$ (par. 2.1.2). For a stall event to occur, the output frequency must have remained below this limit.

Parameters 2.7.15—2.7.18, Underload protection:**General**

The purpose of the motor underload protection is to ensure that there is load on the motor when the drive is running. If the motor loses its load there might be a problem in the process, e.g. a broken belt or a dry pump.

Motor underload protection can be adjusted by setting the underload curve with parameters 2.7.16 (Field weakening area load) and 2.7.17 (Zero frequency load), see below. The underload curve is a squared curve set between the zero frequency and the field weakening point. The protection is not active below 5 Hz (the underload time counter is stopped).

The torque values for setting the underload curve are set in percentage which refers to the nominal torque of the motor. The motor's name plate data, the parameter Motor nominal current and the drive's nominal current I_L are used to find the scaling ratio for the internal torque value. If other than nominal motor is used with the drive, the accuracy of the torque calculation decreases.

2.7.15 Underload protection

0 = No response

1 = Warning

2 = Fault, stop mode after fault according to parameter 2.1.12

3 = Fault, stop mode after fault always by coasting

If tripping is set active the drive will stop and activate the fault stage.

Deactivating the protection by setting the parameter to 0 will reset the underload time counter.

2.7.16 Underload protection, field weakening area load

The torque limit can be set between 10.0—150.0 % x T_{nMotor} .

This parameter gives the value for the minimum torque allowed when the output frequency is above the field weakening point. See Figure 1- 21.

If you change the parameter 2.1.9 (Motor nominal current) this parameter is automatically restored to the default value.

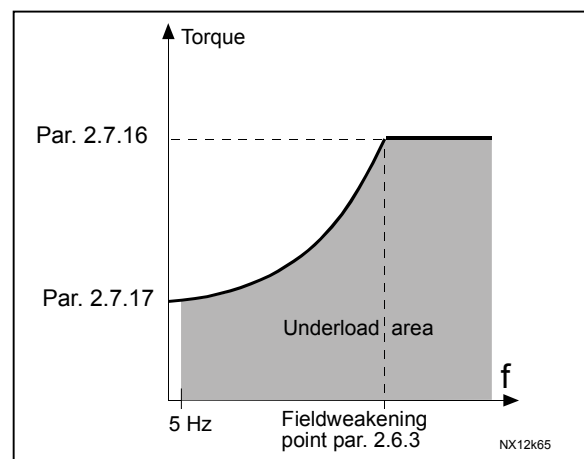

Figure 1- 21. Setting of minimum load

2.7.17 Underload protection, zero frequency load

The torque limit can be set between 5.0—150.0 % x T_{nMotor} .

This parameter gives value for the minimum torque allowed with zero frequency. See Figure 1- 21.

If you change the value of parameter 2.1.9 (Motor nominal current) this parameter is automatically restored to the default value.

2.7.18 Underload time

This time can be set between 2.0 and 600.0 s.

This is the maximum time allowed for an underload state to exist. An internal up/down counter counts the accumulated underload time. If the underload counter value goes above this limit the protection will cause a trip according to parameter 2.7.15). If the drive is stopped the underload counter is reset to zero. See Figure 1- 22.

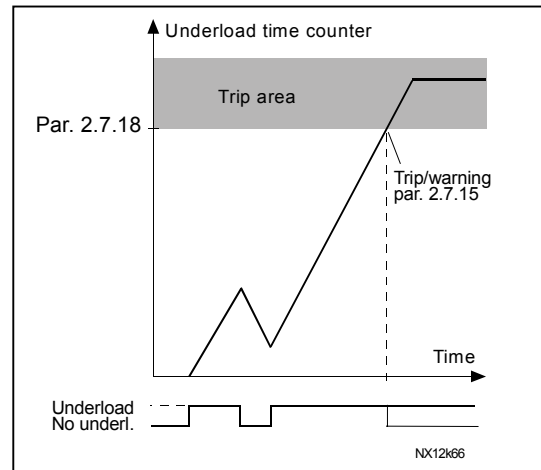

Figure 1- 22. Underload time counter function

2.7.19 Response to thermistor fault

0 = No response

1 = Warning

2 = Fault, stop mode after fault according to parameter 2.1.12

3 = Fault, stop mode after fault always by coasting

Setting the parameter to 0 will deactivate the protection.

2.7.20 Response to fieldbus fault

Set here the response mode for the fieldbus fault if a fieldbus board is used. For more information, see the respective Fieldbus Board Manual.

See parameter 2.7.19.

2.7.21 Response to slot fault

Set here the response mode for a board slot fault due to missing or broken board.

See parameter 2.7.19.

2.7.22 Actual value supervision function

0 = Not used

1 = Warning, if actual value falls below the limit set with par. 2.7.23

2 = Warning, if actual value exceeds the limit set with par. 2.7.23

3 = Fault, if actual value falls below the limit set with par. 2.7.23

4 = Fault, if actual value exceeds the limit set with par. 2.7.23

2.7.23 Actual value supervision limit

With this parameter you can set the limit of actual value supervised by par. 2.7.22

2.7.24 Actual value supervision delay

Set here the delay for the actual value supervision function (par. 2.7.22)

If this parameter is in use, the function of par. 2.7.22 will be active only when the actual value stays outside the defined limit for the time determined by this parameter.

4.8 AUTO RESTART PARAMETERS

The automatic restart function is active if the value of par. 2.1.21 = 1. There are always three restart trials

2.8.1 Automatic restart: Wait time

Defines the time before the frequency converter tries to automatically restart the motor after the fault has disappeared.

2.8.2 Automatic restart: Trial time

The Automatic restart function restarts the frequency converter when the faults have disappeared and the waiting time has elapsed.

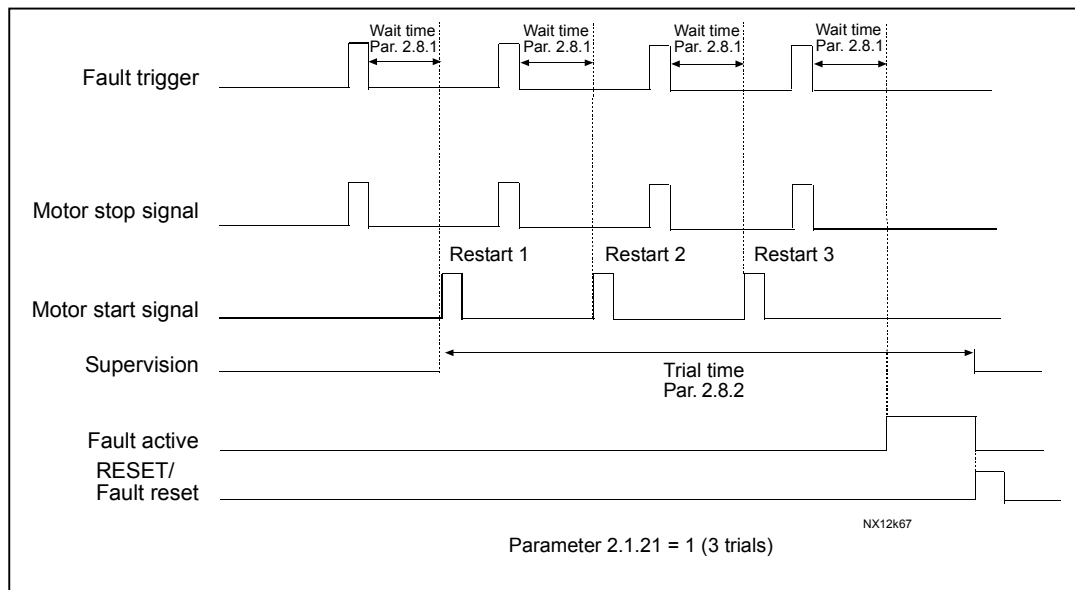

Figure 1- 23. Automatic restart.

The time count starts from the first autorestart. If the number of faults occurring during the trial time exceeds three, the fault state becomes active. Otherwise the fault is cleared after the trial time has elapsed and the next fault starts the trial time count again. If a single fault remains during the trial time, a fault state is true.

2.8.3 Automatic restart, start function

The Start function for Automatic restart is selected with this parameter. The parameter defines the start mode:

- 0 = Start with ramp
- 1 = Flying start
- 2 = Start according to par. 2.1.11

4.9 PID REFERENCE PARAMETERS

2.9.1 *PID activation*

With this parameter you can activate or deactivate the PID controller or activate the pump and fan control parameters.

0 = PID controller deactivated

1 = PID controller activated

2 = Pump and fan control activated. Parameter group P2.10 becomes visible.

2.9.2 *PID reference*

Defines which frequency reference source is selected for the PID controller. Default value is 2.

0 = AI1 reference

1 = AI2 reference

2 = PID reference from the Keypad control page (Group K3, parameter P3.5)

3 = Reference from the fieldbus (FBProcessDataIN1)

2.9.3 *Actual value input*

1 AI1

2 AI2

3 Fieldbus (*Actual value 1*: FBProcessDataIN2; *Actual value 2*: FBProcessDataIN3)

4 Motor torque

5 Motor speed

6 Motor current

7 Motor power

2.9.4 *PID controller gain*

This parameter defines the gain of the PID controller. If the value of the parameter is set to 100% a change of 10% in the error value causes the controller output to change by 10%.

If the parameter value is set to **0** the PID controller operates as ID-controller.

See examples below.

2.9.5 *PID controller I-time*

This parameter defines the integration time of the PID controller. If this parameter is set to 1,00 second a change of 10% in the error value causes the controller output to change by 10.00%/s. If the parameter value is set to 0.00 s the PID controller will operate as PD-controller. See examples below.

2.9.6 *PID controller D-time*

The parameter 2.9.5 defines the derivation time of the PID controller. If this parameter is set to 1,00 second a change of 10% in the error value during 1.00 s causes the controller output to change by 10.00%. If the parameter value is set to 0.00 s the PID controller will operate as PI-controller.

See examples below.

Example 1:

In order to reduce the error value to zero, with the given values, the frequency converter output behaves as follows:

Given values:

Par. 2.9.4, P = 0%

PID max limit = 100.0%

Par. 2.9.5, I-time = 1.00 s

PID min limit = 0.0%

Par. 2.9.6, D-time = 0.00 s

Min freq. = 0 Hz

Error value (setpoint – process value) = 10.00% Max freq. = 50 Hz

In this example, the PID controller operates practically as I-controller only. According to the given value of parameter 2.9.5 (I-time), the PID output increases by 5 Hz (10% of the difference between the maximum and minimum frequency) every second until the error value is 0.

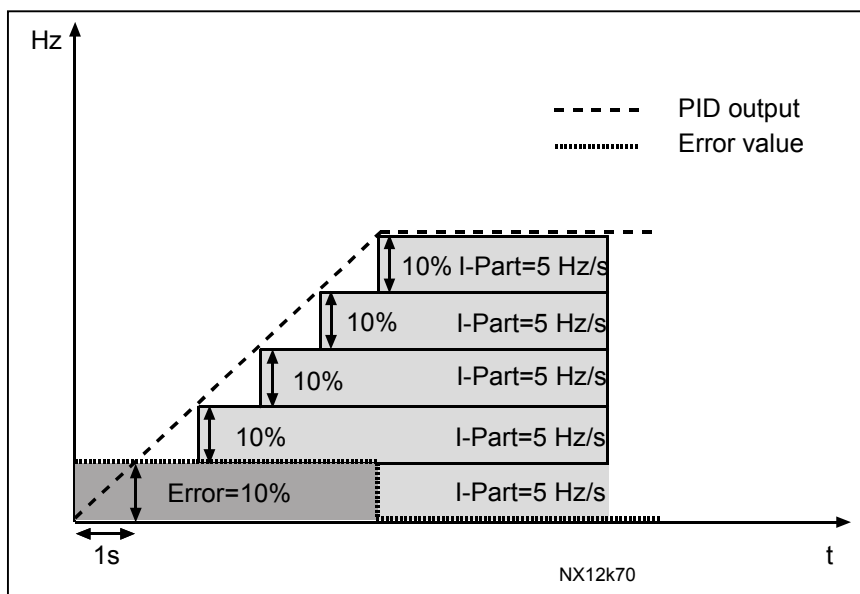

Figure 1- 24. PID controller function as I-controller

Example 2:Given values:

Par. 2.9.4, P = 100%

PID max limit = 100.0%

Par. 2.9.5, I-time = 1.00 s

PID min limit = 0.0%

Par. 2.9.6, D-time = 1.00 s

Min freq. = 0 Hz

Error value (setpoint – process value) = $\pm 10\%$ Max freq. = 50 Hz

As the power is switched on, the system detects the difference between the setpoint and the actual process value and starts to either raise or decrease (in case the error value is negative) the PID output according to the I-time. Once the difference between the setpoint and the process value has been reduced to 0 the output is reduced by the amount corresponding to the value of parameter 2.9.5.

In case the error value is negative, the frequency converter reacts reducing the output correspondingly.

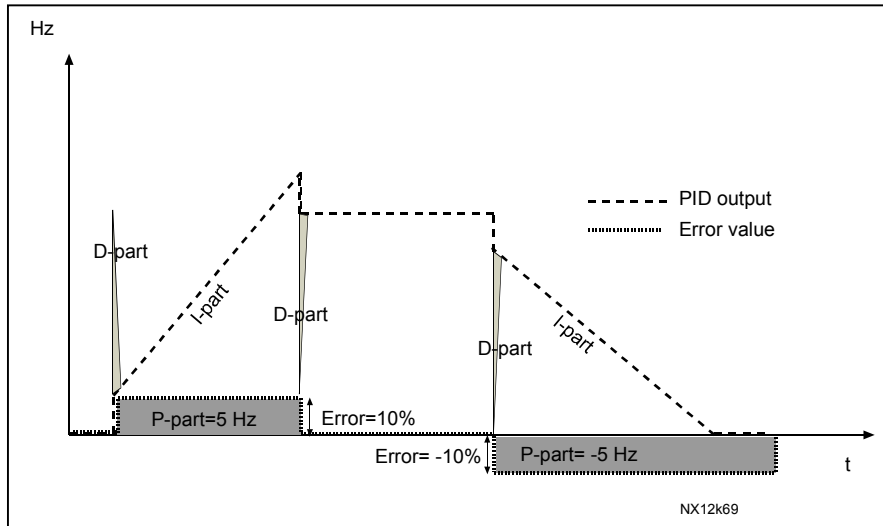

Figure 1- 25. PID output curve with the values of Example 2

Example 3:

Given values:

Par. 2.9.4, P = 100%

PID max limit = 100.0%

Par. 2.9.5, I-time = 0.00 s

PID min limit = 0.0%

Par. 2.9.6, D-time = 1.00 s

Min freq. = 0 Hz

Error value (setpoint – process value) = $\pm 10\%/s$ Max freq. = 50 Hz

As the error value increases, also the PID output increases according to the set values (D-time = 1.00s).

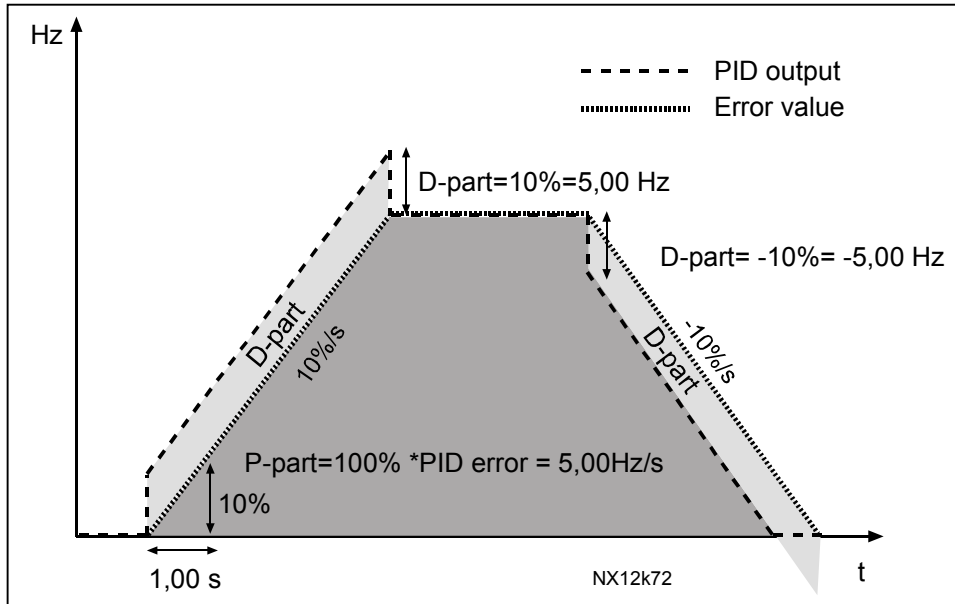

Figure 1- 26. PID output with the values of Example 3.

2.9.7 Actual value 1 minimum scale

Sets the minimum scaling point for Actual value 1. See Figure 1- 27

2.9.8 Actual value 1 maximum scale

Sets the maximum scaling point for Actual value 1. See Figure 1- 27

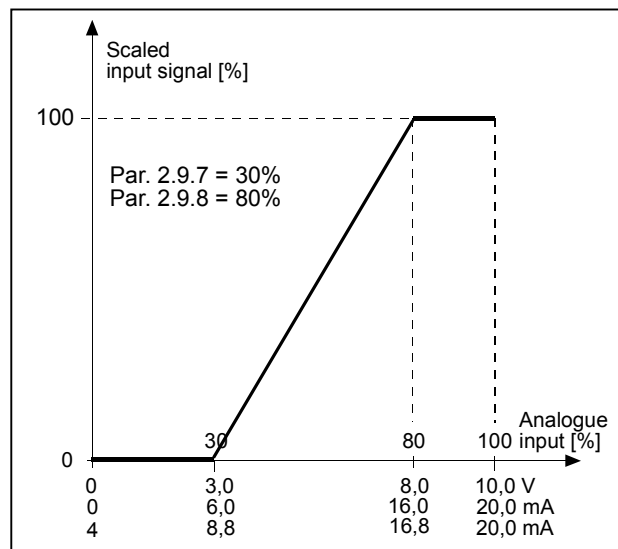

Figure 1- 27. Example of actual value signal scaling

2.9.9 *PID error value inversion*

This parameter allows you to invert the error value of the PID controller (and thus the operation of the PID controller).

0 No inversion

1 Inverted

2.9.10 *Sleep frequency*

The frequency converter is stopped automatically if the frequency of the drive falls below the Sleep level defined with this parameter for a time greater than that determined by parameter 2.9.11. During the Stop state, the PID controller is operating switching the frequency converter to Run state when the actual value signal either falls below or exceeds (see par. 2.9.13) the Wake-up level determined by parameter 2.9.12. See Figure 1- 28

2.9.11 *Sleep delay*

The minimum amount of time the frequency has to remain below the Sleep level before the frequency converter is stopped. See Figure 1- 28

2.9.12 *Wake-up level*

The wake-up level defines the frequency below which the actual value must fall or which has to be exceeded before the Run state of the frequency converter is restored. See Figure 1- 28

2.9.13 *Wake-up function*

This parameter defines if the restoration of the Run state occurs when the actual value signal falls below or exceeds the *Wake-up level* (par. 2.9.12). See Figure 1- 28

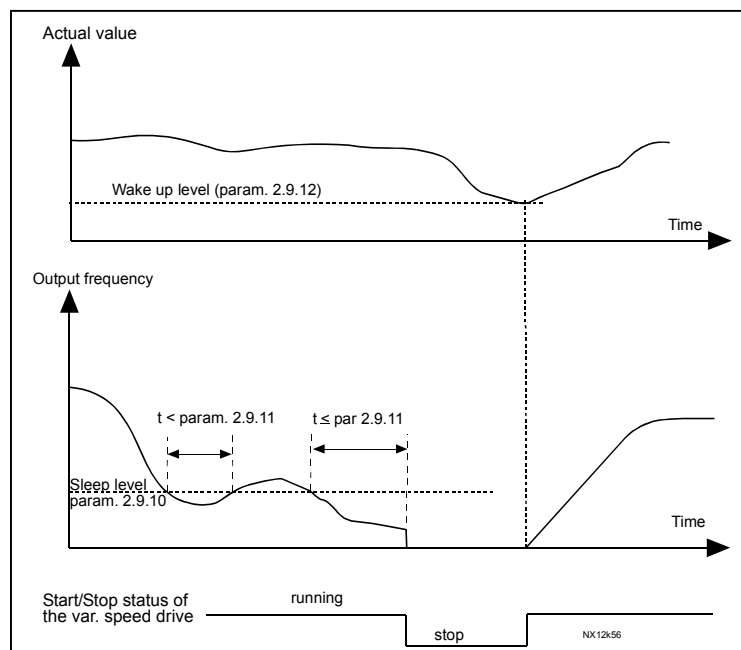

Figure 1- 28. Frequency converter sleep function

4.10 PUMP AND FAN CONTROL

The Pump and Fan Control can be used to control one variable speed drive and up to 3 auxiliary drives. The PID controller of the frequency converter controls the speed of the variable speed drive and gives control signals to start and stop the auxiliary drives to control the total flow. In addition to the eight parameter groups provided as standard, a parameter group for multi-pump and fan control functions is available.

As already its name tells, the Pump and Fan Control is used to control the operation of pumps and fans. The application utilizes external contactors for switching between the motors connected to the frequency converter. The autochange feature provides the capability of changing the starting order of the auxiliary drives.

4.10.1 Short description of PFC function and essential parameters

Automatic changing between drives (Autochange & Interlockings selection, P2.10.4)

The automatic change of starting and stopping order is activated and applied to either the auxiliary drives only or the auxiliary drives **and** the drive controlled by the frequency converter depending on the setting of parameter 2.10.4.

The *Autochange function* allows the starting and stopping order of drives controlled by the pump and fan automatics to be changed at desired intervals. The drive controlled by frequency converter can also be included in the automatic changing and locking sequence (par 2.10.4). The Autochange function makes it possible to equalize the run times of the motors and to prevent e.g. pump stalls due to too long running breaks.

- Apply the Autochange function with parameter 2.10.4, *Autochange*.
- The autochange takes place when the time set with parameter 2.10.5 *Autochange interval*, has expired and the capacity used is below the level defined with parameter 2.10.7, *Autochange frequency limit*.
- The running drives are stopped and re-started according to the new order.
- External contactors controlled through the relay outputs of the frequency converter connect the drives to the frequency converter or to the mains. If the motor controlled by the frequency converter is included in the autochange sequence, it is always controlled through the relay output activated first. The other relays activated later control the auxiliary drives

This parameter is used to activate the interlock inputs (Values 3 & 4). The interlocking signals come from the motor switches. The signals (functions) are connected to digital inputs which are programmed as interlock inputs using the corresponding parameters. The pump and fan control automatics only control the motors with active interlock data.

- If the interlock of an auxiliary drive is inactivated and another unused auxiliary drive available, the latter will be put to use without stopping the frequency converter.
- If the interlock of the controlled drive is inactivated, all motors will be stopped and re-started with the new set-up.

- If the interlock is re-activated in Run status, the automatics will stop all motors immediately and re-start with a new set-up. Example: $[P1 \rightarrow P3] \rightarrow [P2 \text{ LOCKED}] \rightarrow [STOP] \rightarrow [P1 \rightarrow P2 \rightarrow P3]$

See Chapter 4.10.2, Examples.

Parameter 2.10.5, Autochange interval

After the expiry of the time defined with this parameter, the autochange function takes place if the capacity used lies below the level defined with parameters 2.10.7 (*Autochange frequency limit*) and 2.10.6 (*Maximum number of auxiliary drives*). Should the capacity exceed the value of par 2.10.7, the autochange will not take place before the capacity goes below this limit.

- The time count is activated only if the Start/Stop request is active.
- The time count is reset after the autochange has taken place or on removal of Start request

Parameters 2.10.6, Maximum number of auxiliary drives and 2.10.7, Autochange frequency limit

These parameters define the level below which the capacity used must remain so that the autochange can take place.

This level is defined as follows:

- If the number of running auxiliary drives is smaller than the value of parameter 2.10.6 the autochange function can take place.
- If the number of running auxiliary drives is equal to the value of parameter 2.10.6 and the frequency of the controlled drive is below the value of parameter 2.10.7 the autochange can take place.
- If the value of parameter 2.10.7 is 0.0 Hz, the autochange can take place only in rest position (Stop and Sleep) regardless of the value of parameter 2.10.6.

4.10.2 Examples

PFC with interlocks and autochange between 3 pumps (NXOPTB5 option board required)

Situation: 1 controlled drive and 2 auxiliary drives.

Parameter settings: 2.10.1= 2

Interlock feedback signals used, autochange between all drives used.

Parameter settings: 2.10.4=4

The interlock feedback signals come from the digital input DIN1 and digital inputs DIN2 & DIN3 selected with parameters 2.1.17 to 2.1.18.

The control of pump 1 (par.2.3.1=17) is enabled through Interlock 1 (DIN 1), the control of pump 2 (par.2.3.2=18) through Interlock 2 (par. 2.1.17=10) and the control of pump 3 (par.2.3.3=19) through Interlock 3 (par. 2.1.18=13)

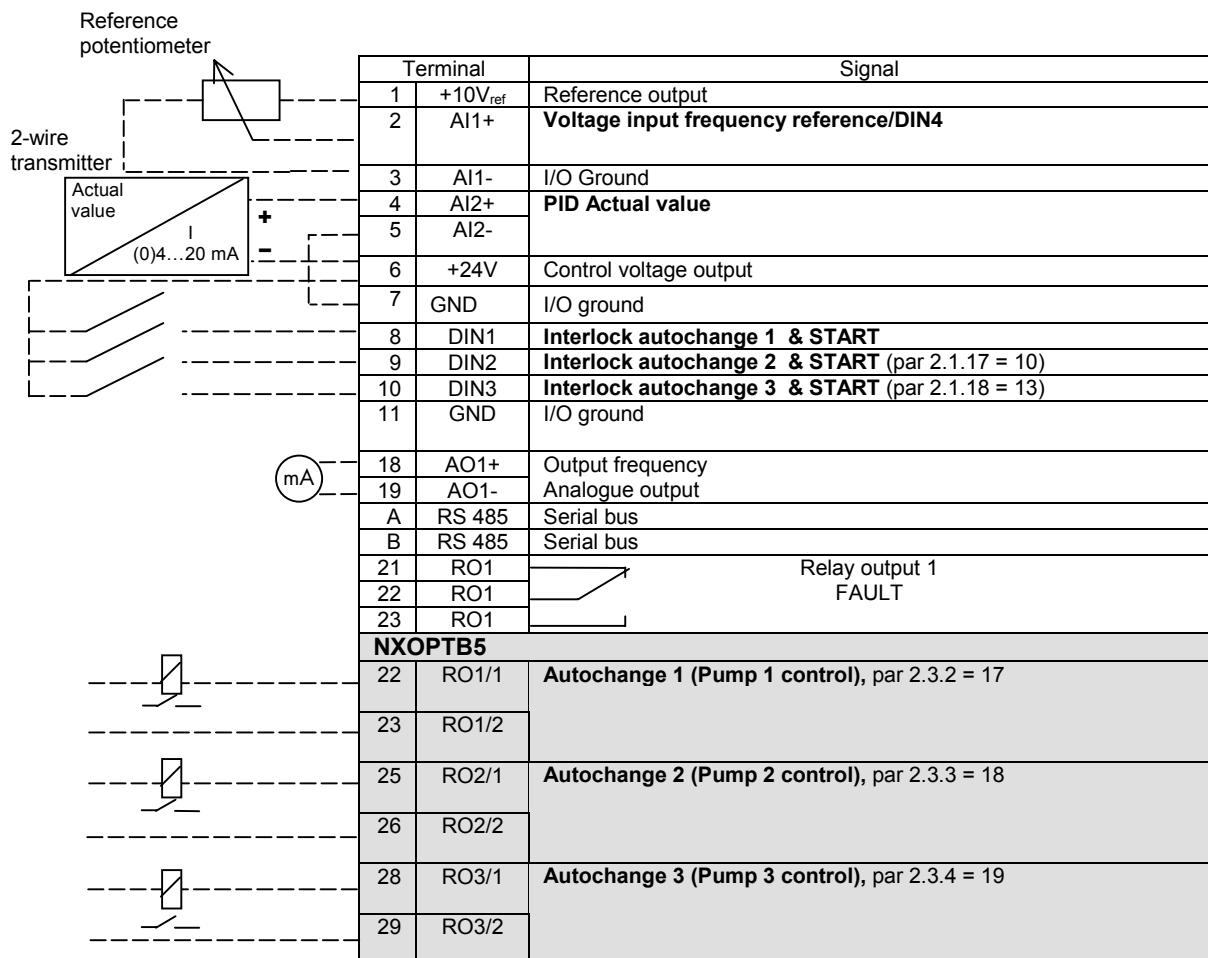

Table 1- 17. Example of PFC-control I/O configuration with interlocks and autochange between 3 pumps

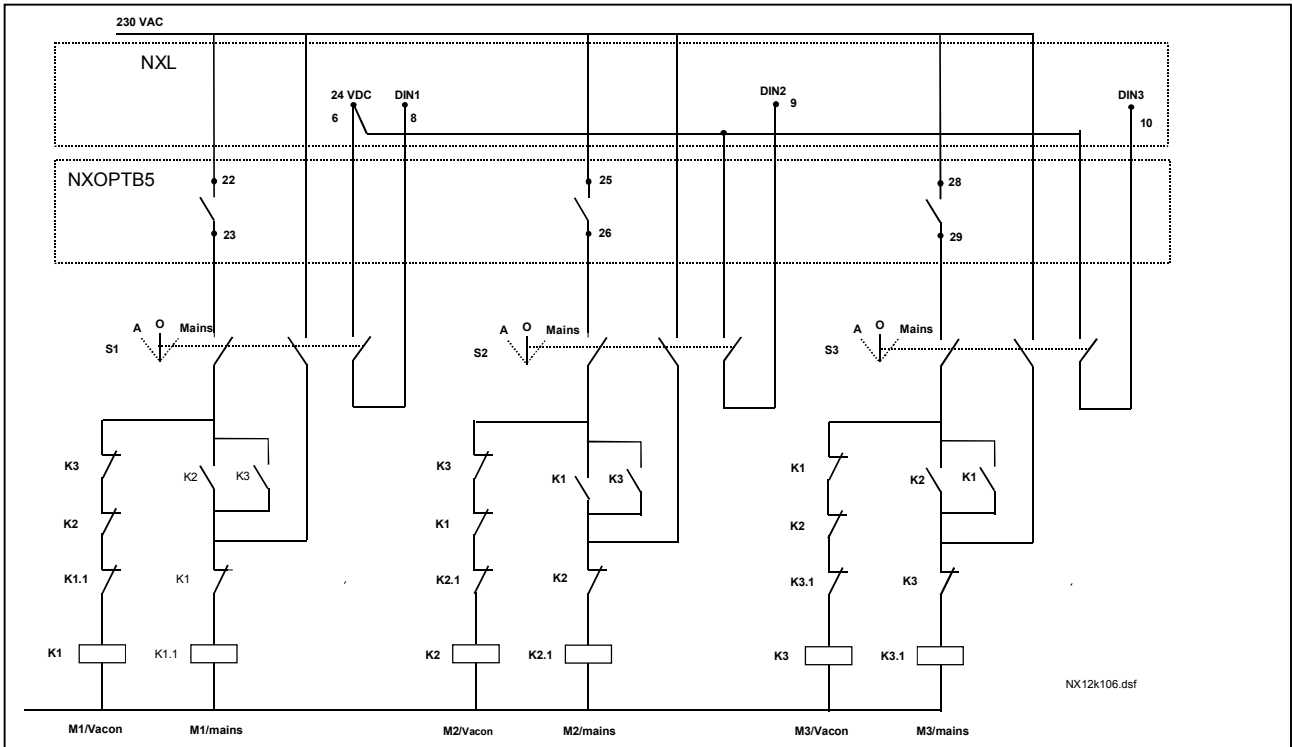

Figure 1- 29. 3-pump autochange system, principal control diagram

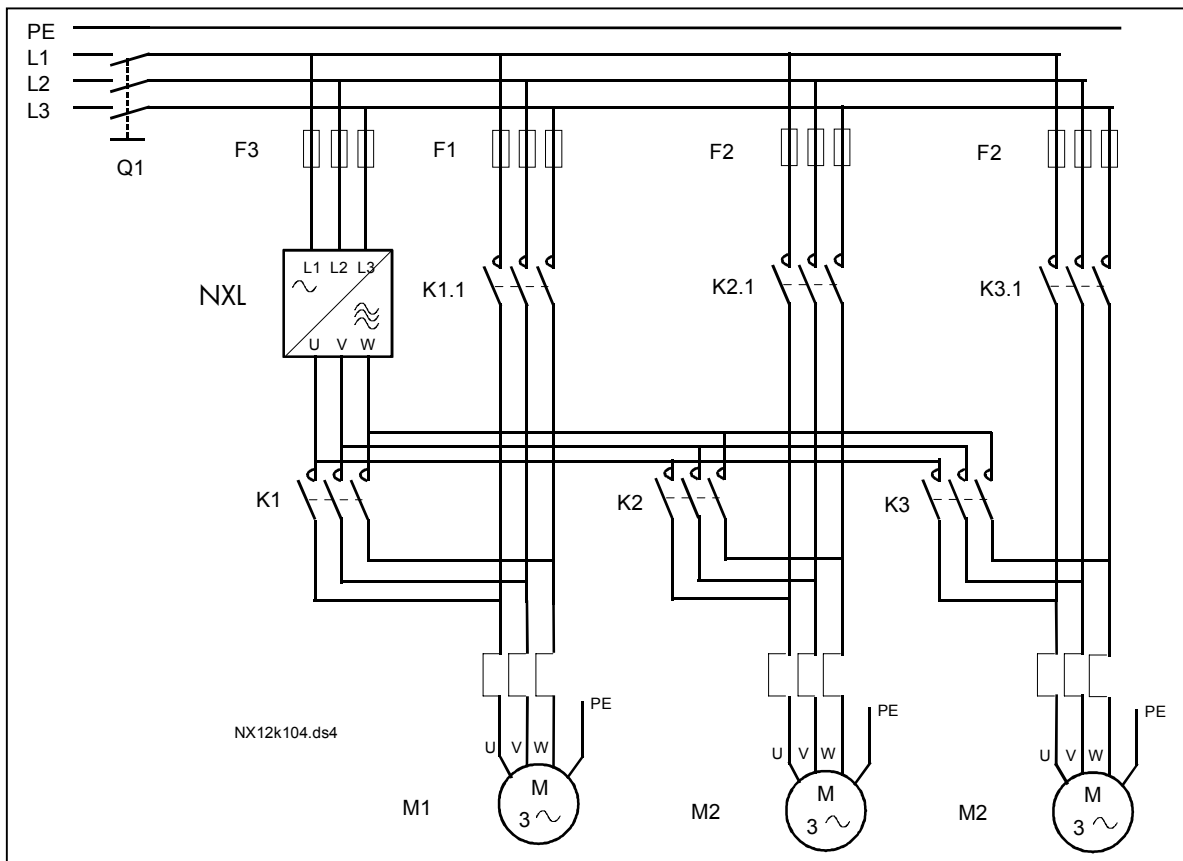

Figure 1- 30. Example of 3-pump autochange, main diagram

PFC with interlocks and autochange between 2 pumps (NXOPTAA or NXOPTB5 option board required)

Situation: 1 controlled drive and 1 auxiliary drive.

Parameter settings: 2.10.1= 1

Interlock feedback signals used, autochange between pumps used.

Parameter settings: 2.10.4=4

The interlock feedback signals come from the digital input DIN1 and digital input DIN2 selected with parameters 2.1.17.

The control of pump 1 (par.2.3.1=17) is enabled through Interlock 1 (DIN 1), the control of pump 2 (par.2.3.2=18) through Interlock 2 (par. 2.1.17=10)

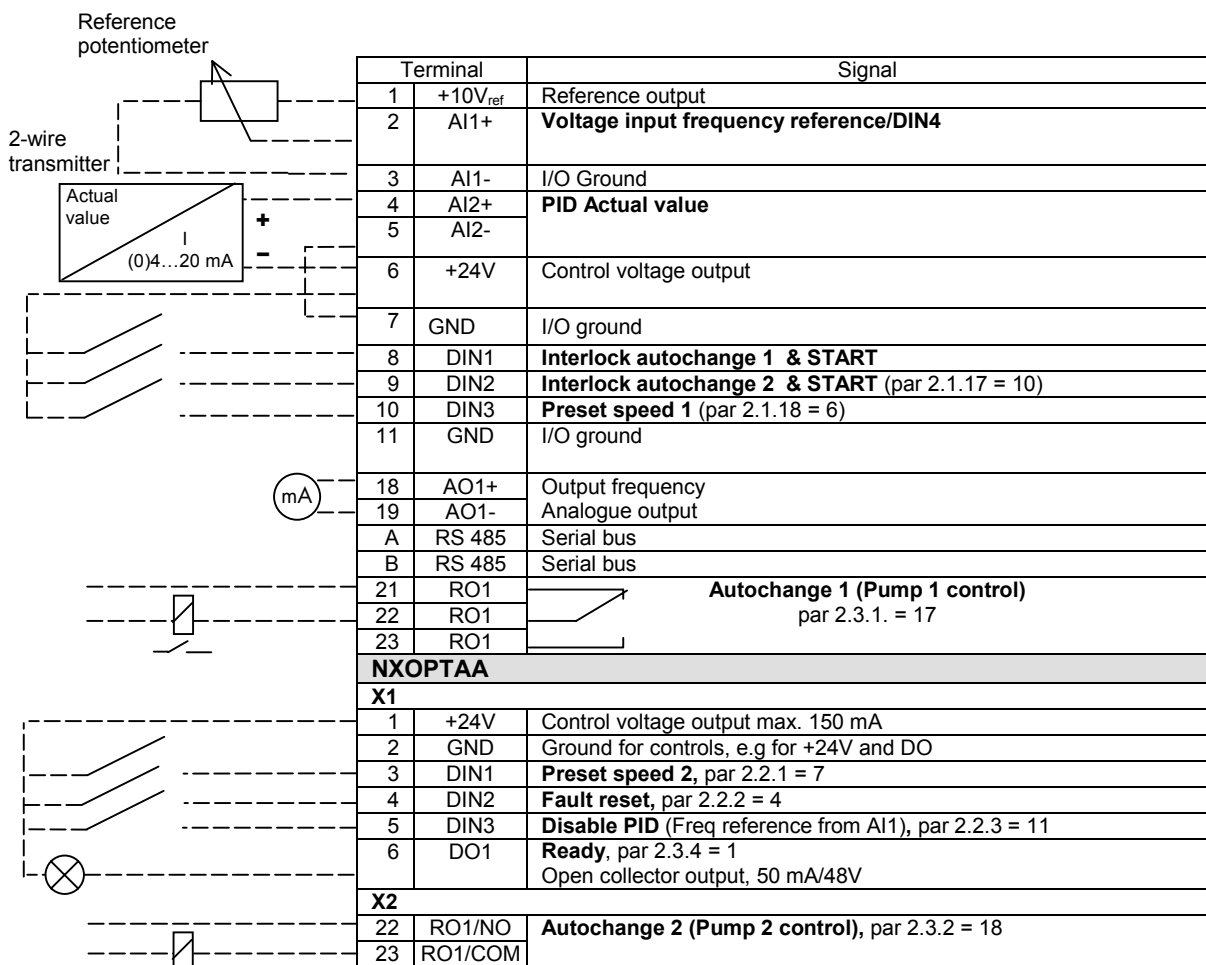

Table 1- 18. Example of PFC-control I/O configuration with interlocks and autochange between 2 pumps

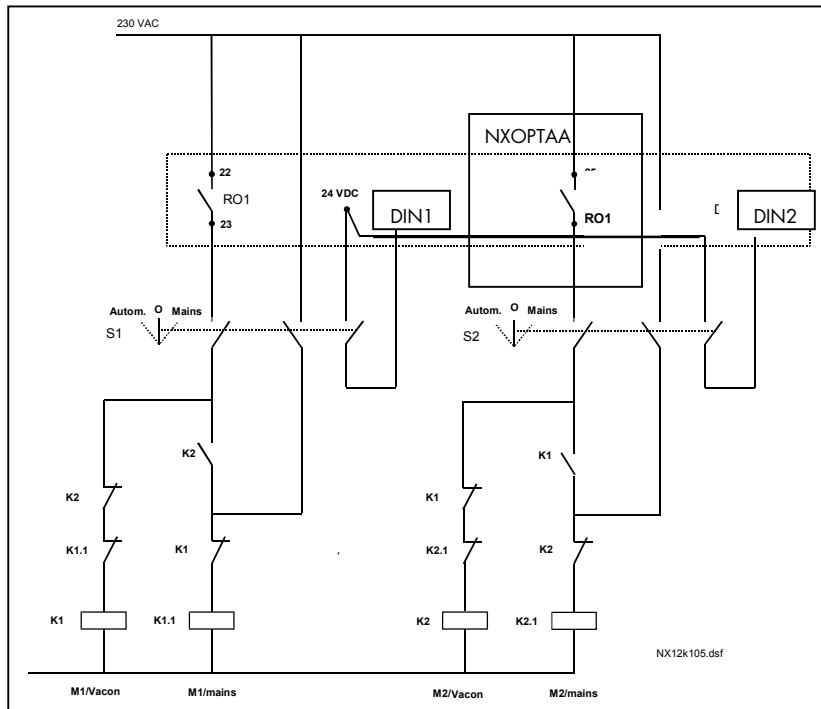

Figure 1- 31. 2-pump autochange system, principal control diagram

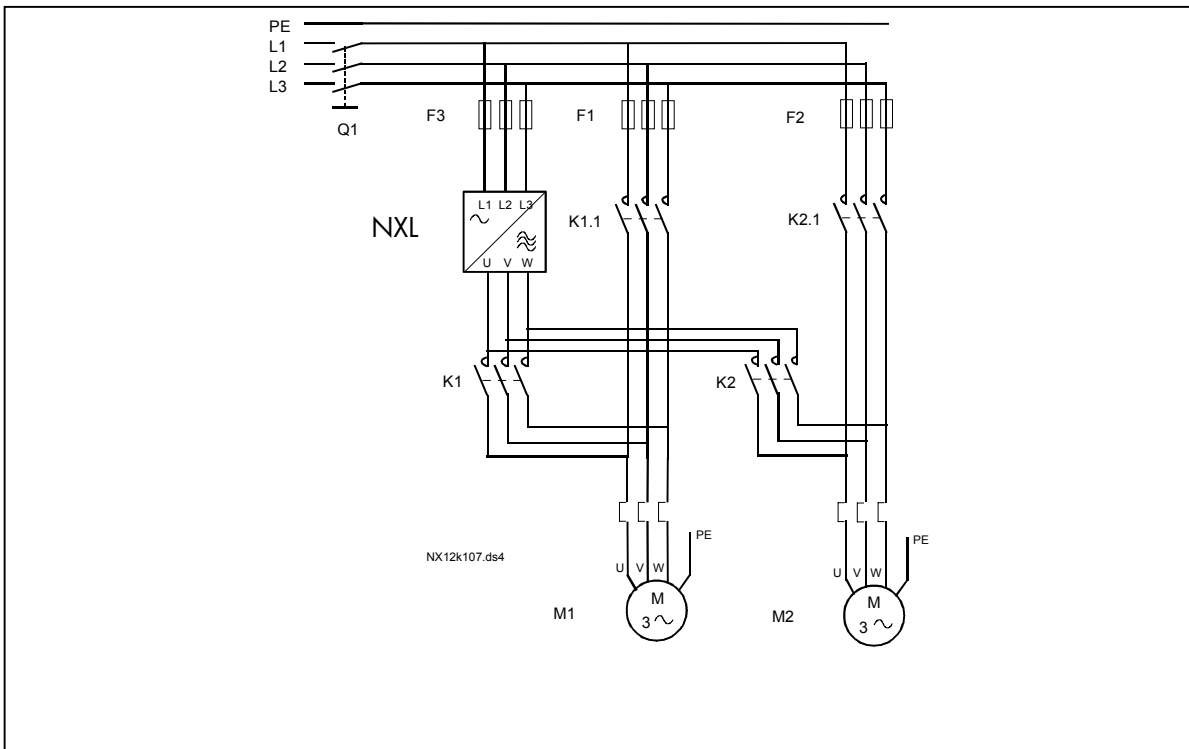

Figure 1- 32. Example of 2-pump autochange, main diagram

4.10.3 Description of Pump and Fan control parameters

2.10.1 Number of auxiliary drives

With this parameter the number of auxiliary drives in use will be defined. The functions controlling the auxiliary drives (parameters 2.10.4 to 2.10.7) can be programmed to relay outputs.

2.10.2 Start delay of auxiliary drives

The frequency of the drive controlled by the frequency converter must remain above the maximum frequency for the time defined with this parameter before the auxiliary drive is started. The delay defined applies to all auxiliary drives. This prevents unnecessary starts caused by momentary start limit exceedings..

2.10.3 Stop delay of auxiliary drives

The frequency of the drive controlled by the frequency converter must remain below the minimum frequency for the time defined with this parameter before the drive is stopped. The delay defined applies to all auxiliary drives. This prevents unnecessary stops caused by momentary falls below the stop limit.

2.10.4 Automatic changing between drives

0= Not used

1= Autochange with aux pumps

The drive controlled by the frequency converter remains the same. Therefore, mains contactor is needed for one auxiliary drive only.

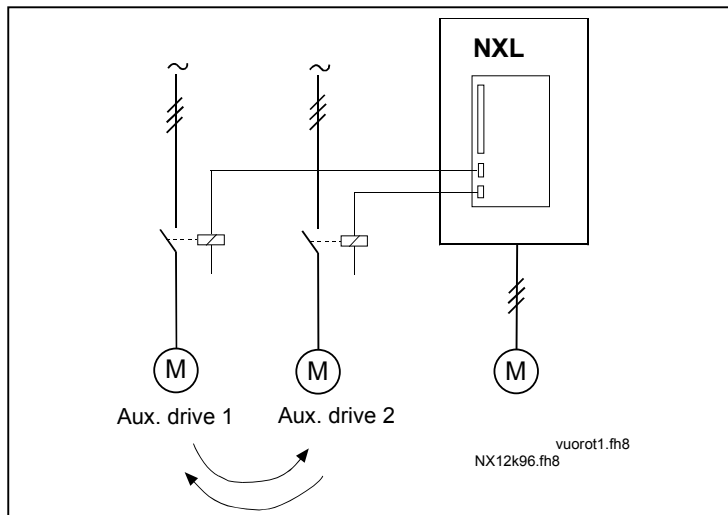

Figure 1- 33. Autochange applied to auxiliary drives only.

2= Autochange with frequency converter and auxiliary pumps

The drive controlled by the frequency converter is included in the automatics and a contactor is needed for each drive to connect it to either the mains or the frequency converter

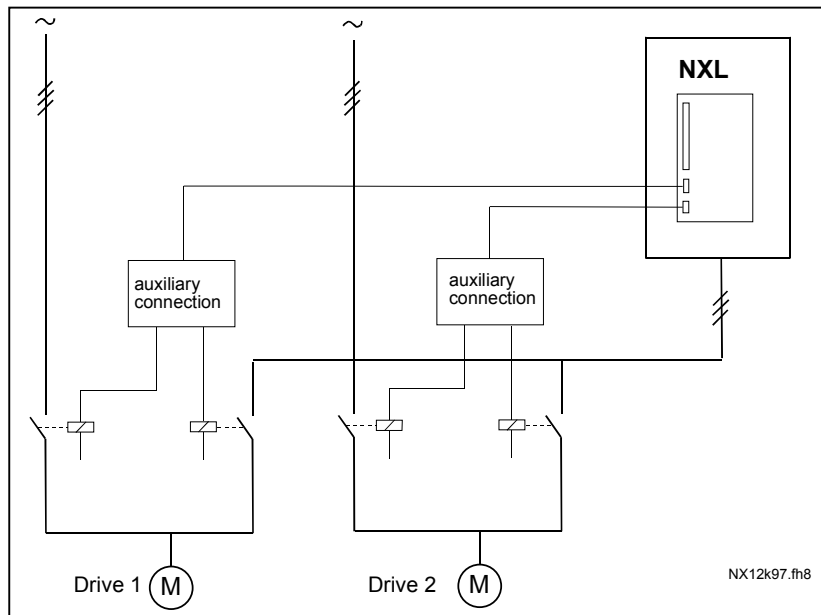

Figure 1- 34. Autochange with all drives

3= Autochange and interlocks (only auxiliary pumps)

The drive controlled by the frequency converter remains the same. Therefore, mains contactor is needed for one auxiliary drive only. DIN 1 is automatically the interlock for autochange output 1. Interlocks for autochange outputs 2 & 3 can be selected with par 2.1.17 and 2.1.18.

4= Autochange and interlocks (Freq. conv & aux pumps)

The drive controlled by the frequency converter is included in the automatics and a contactor is needed for each drive to connect it to either the mains or the frequency converter. DIN 1 is automatically intelock for Autochange output 1. Interlocks for Autochange output 2 & 3 can be selected with Par.P2.1.17 & P2.1.18.

NOTE! INTERLOCK INPUTS ARE ALSO START COMMANDS FOR THE FREQUENCY CONVERTER! (If one of these interlock inputs is active --> 1st motor is started !!!)

2.10.5 Autochange interval

After the expiry of the time defined with this parameter, the autochange function takes place if the capacity used lies below the level defined with parameters 2.10.7 (*Autochange frequency limit*) and 2.10.6 (*Maximum number of auxiliary drives*). Should the capacity exceed the value of P2.10.7, the autochange will not take place before the capacity goes below this limit.

- The time count is activated only if the Start/Stop request is active.
- The time count is reset after the autochange has taken place or on removal of Start request

2.10.6 Maximum number of auxiliary drives**2.10.7 Autochange frequency limit**

These parameters define the level below which the capacity used must remain so that the autochange can take place.

This level is defined as follows:

- If the number of running auxiliary drives is smaller than the value of parameter 2.10.6 the autochange function can take place.
- If the number of running auxiliary drives is equal to the value of parameter 2.10.6 and the frequency of the controlled drive is below the value of parameter 2.10.7 the autochange can take place.
- If the value of parameter 2.10.7 is 0.0 Hz, the autochange can take place only in rest position (Stop and Sleep) regardless of the value of parameter 2.10.6.

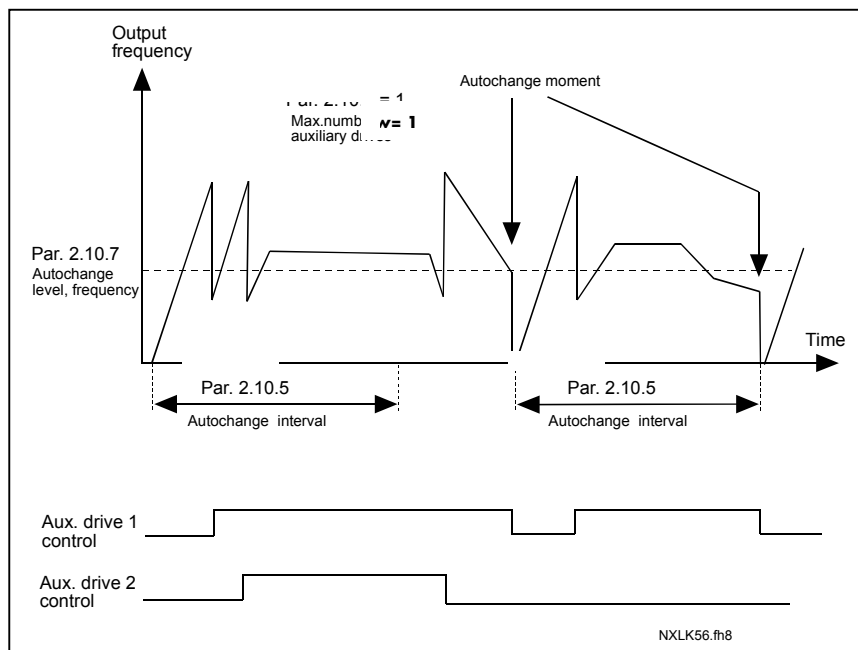

Figure 1- 35. Autochange interval and limits

4.11 KEYPAD CONTROL PARAMETERS

3.1 *Control place*

The active control place can be changed with this parameter. For more information, see NXL User's Manual, Chapter 7.3.3.

3.2 *Keypad reference*

The frequency reference can be adjusted from the keypad with this parameter. For more information, see NXL User's Manual, Chapter 7.3.3.2.

3.3 *Keypad direction*

0 Forward: The rotation of the motor is forward, when the keypad is the active control place.

1 Reverse: The rotation of the motor is reversed, when the keypad is the active control place.

For more information, see NXL User's Manual, Chapter 7.3.3.3.

3.4 *Stop button activated*

If you wish to make the Stop button a "hotspot" which always stops the drive regardless of the selected control place, give this parameter the value **1** (default). See NXL User's Manual, Chapter 7.3.3.

See also parameter 3.1.

3.5 *PID reference 1*

The PID controller keypad reference can be set between 0% and 100%. This reference value is the active PID reference if parameter 2.9.2 = 2.

3.6 *PID reference 2*

The PID controller keypad reference 2 can be set between 0% and 100%. This reference is active if the DIN# function=12 and the DIN# contact is closed.

5. Control signal logic in Multi-Control Application

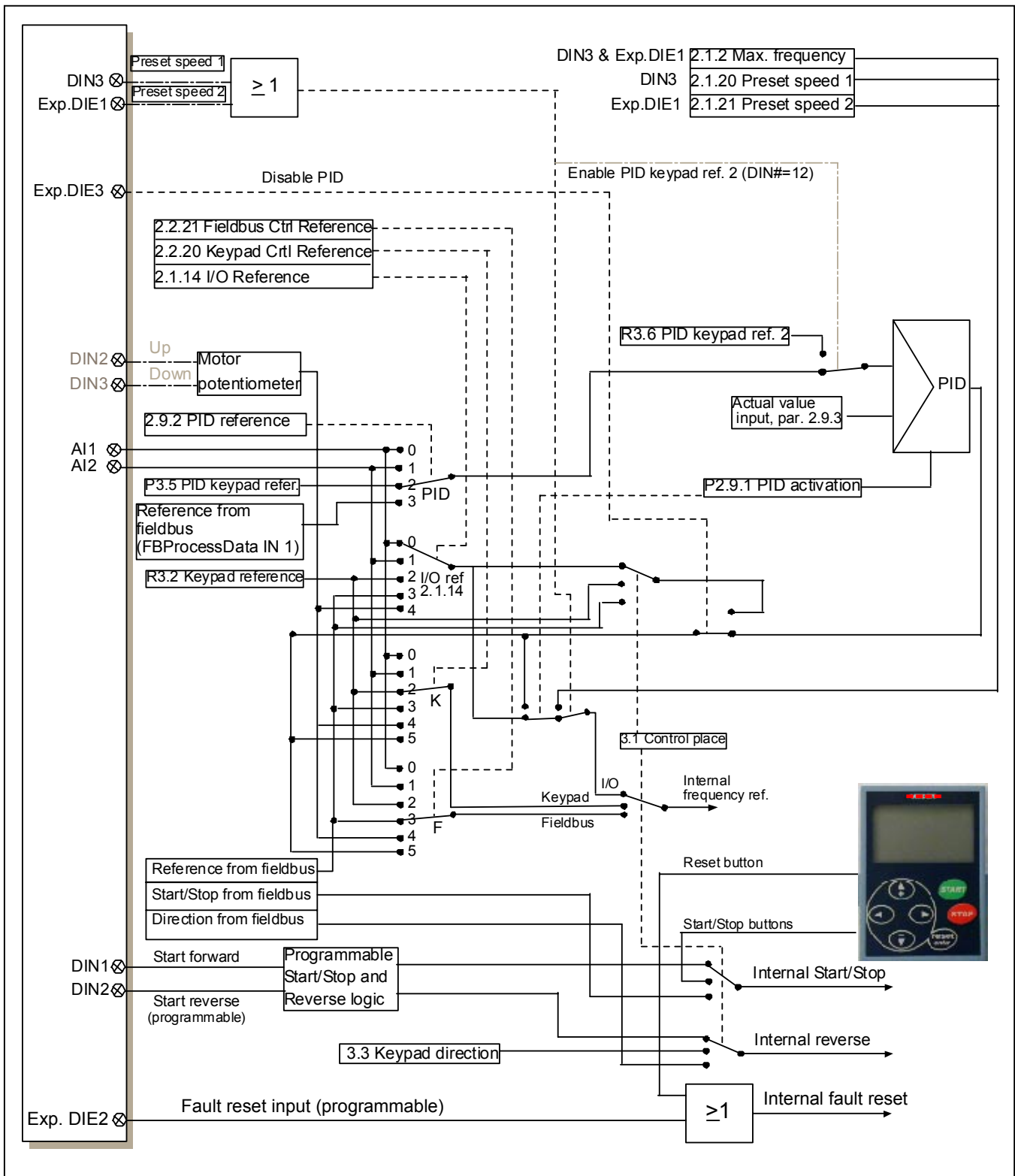

Figure 1- 36. Control signal logic of the Multi-Control Application

Honeywell

Honeywell
1985 Douglas Drive North
Golden Valley, MIN 55422

Honeywell Limited-Honeywell Limitée
35 Dynamic Drive
Scarborough, Ontario
M1V 4Z9

63-2599 3-03

www.honeywell.com