

MS4209F, MS4309F, MS4709F, MS4809F, MS8209F, MS8309F

Fast-Acting, Two-Position Actuators

FOR FIRE/SMOKE CONTROL APPLICATIONS

PRODUCT DATA



FEATURES

- 80 lb-in. (9 N•m) minimum driving torque at 350°F (176°C).
- Integral spring return ensures level of return torque.
- Fifteen-second spring return timing.
- No special cycling required during long-term holding. (See Operation section.)
- No audible noise during holding.
- Patent pending design eliminates need for limit switches to reduce power consumption.
- Models available for 24, 120, and 230 Vac.
- Ninety-five degree angle of rotation.
- Actuator holds rated torque at reduced power level.
- Die-cast aluminum housing.
- Housing design allows flush mounting to damper.
- Integral junction box with three conduit openings eliminates need for separate wiring box.

APPLICATION

The MS4209F, MS4309F, MS4709F, MS4809F, MS8209F, MS8309F Fast-Acting, Two-Position Actuators are spring return direct coupled actuators (DCA) with an integral junction box for on/off damper control. The actuator accepts an on/off signal from a single-pole, single-throw (spst) controller. Models are available with clockwise (cw) or counterclockwise (ccw) spring return and are designed to operate reliably in smoke control systems requiring Underwriter's Laboratories Inc. UL555S ratings up to 350°F.

APPLICABLE LITERATURE

- | | |
|---|---------|
| — Motor/Actuator Selection Guide for Damper Applications | 63-8419 |
| — Engineering Manual of Automatic Control (also called The Gray Manual) | 77-1100 |
| — Direct Coupled Actuator Quick Selection Guide | 63-8553 |
| — Damper Torque Calculator | 63-8437 |

SPECIFICATIONS

Models: See Table 1.

Table 1. MS4209, MS4309, MS4709, MS4809, MS8209, MS8309 DCA Models.

Model	Spring Return Direction	Voltage in Vac	Torque in lb-in. (N•m)
MS4209F	cw	120	80 (9)
MS4309F	ccw		
MS4709F	cw	230	
MS4809F	ccw		
MS8209F	cw	24	
MS8309F	ccw		

Dimensions: See Fig. 1.

Electrical Ratings:

Power Input:

MS4209, MS4309: 120 Vac +10%, -15%, 60 Hz.

MS4709, MS4809: 230 Vac ±10%, 50/60 Hz.

MS8209, MS8309: 24 Vac +20%, -10%, 50/60 Hz.

Power Consumption (at Rated Voltage):

MS4209, MS4309: Holding: 0.13A, 7W.

Running (at 80 lb-in.): 0.25A, 23W.

MS4709, MS4809: Holding: 0.09A, 7W.

Running (at 80 lb-in.): 0.13A, 23W.

MS8209, MS8309: Holding: 7 VA.

Running (at 80 lb-in.): 23 VA.

Electrical Connections:

MS4209, MS4309, MS8209, MS8309: Two color coded 16 in. leads.

MS4709, MS4809: 1m appliance cable.

Ground screw.

Three 7/8 in. conduit connection holes (fittings not included).

Device Weight: 5 lb (2.3 kg).

Stroke: 95° ± 3°, mechanically limited.

Noise Ratings (Maximum):

Driving Open: 80 dBA at 1m.

Holding: 20 dBA at 1m (no audible noise).

Controller Type:

MS4209, MS4309: Line voltage (120 Vac), two-position, spst (Series 40).

MS4709, MS4809: Line voltage (230 Vac), two-position, spst (Series 40).

MS8209, MS8309: Low voltage (24 Vac), two-position, spst (Series 80).

Torque Rating (at Rated Voltage):

Typical Holding (0°F to 350°F): 80 lb-in. (9 N•m).

Typical Driving (0°F to 350°F): 80 lb-in. (9 N•m).

Spring Return: 80 lb-in. (9 N•m).

Stall Maximum: 240 lb-in. (27 N•m).

Temperature Ratings:

Ambient: 0°F to 130°F (-18°C to 55°C).

Shipping and Storage: -40°F to 140°F (-40°C to 60°C).

IMPORTANT

The actuator is designed to meet UL555S standards at 350°F (176°C). The actuator must be tested with the damper to achieve this rating.

Humidity Rating: 5% to 95% RH noncondensing.

Minimum Damper Shaft Length: 1-1/2 in. (38 mm).

Timing (at Rated Torque and Voltage):

Drive Open:

Ambient Conditions: 25 sec maximum, 14 sec typical.

At 350°F: 75 sec maximum.

Spring Close: 20 sec maximum.

Cycling Requirements:

Prolonged holding-period (1 year) testing of these actuators has been performed with no spring return failures. The actuator and the internal spring are designed to require no special cycling during long-term holding.

Honeywell recommends following all local, state and national codes for periodic testing of the entire smoke control system. Refer to National Fire Protection Association (NFPA) National Fire Codes®: NFPA90A, NFPA92A and NFPA92B for your application.

NFPA recommends periodic examination of each fire/smoke damper (semi-annually or annually) to ensure proper performance.

Design Life (at Rated Voltage): 60,000 full stroke cycles.

ORDERING INFORMATION

When purchasing replacement and modernization products from your TRADELINE® wholesaler or distributor, refer to the TRADELINE® Catalog or price sheets for complete ordering number.

If you have additional questions, need further information, or would like to comment on our products or services, please write or phone:

1. Your local Honeywell Automation and Control Products Sales Office (check white pages of your phone directory).

2. Honeywell Customer Care

1885 Douglas Drive North

Minneapolis, Minnesota 55422-4386

In Canada—Honeywell Limited/Honeywell Limitée, 35 Dynamic Drive, Toronto, Ontario M1V 4Z9.

International Sales and Service Offices in all principal cities of the world. Manufacturing in Australia, Canada, Finland, France, Germany, Japan, Mexico, Netherlands, Spain, Taiwan, United Kingdom, U.S.A.

Mounting: 3/8 to 1/2 in. square or round damper shafts.
The actuator can be mounted with shaft in any position.
Secure hub to shaft with:

MS4709, MS4809: Four 3 mm set screws. Use 3 mm Allen wrench to tighten set screws.

MS4209, MS4309, MS8209, MS8309: 1/4-28 UNF set screws. Use 1/8 Allen wrench to tighten set screws.

IMPORTANT

Honeywell does not recommend using linkages with these actuators because side-loading of the output hub reduces actuator life.

Environmental Protection Ratings: See Table 2.

Approvals: See Table 3.

Accessories:

201391 Shaft Adapter for 3/8 in. shafts (not supplied with actuator).

205649 Mounting Bracket (not supplied with actuator).

Table 2. Environmental Ratings.

	MS4209, MS4309	MS4709, MS4809, MS8209, MS8309
NEMA1	X	X
IP54		X

Table 3. Approvals.

	MS4209, MS4309	MS4709, MS4809, MS8209, MS8309
UL/cUL	X	X
UL873 Plenum Rating, File No. E4436; Guide No. XAPX	X	X
CE		X
C-TICK		X

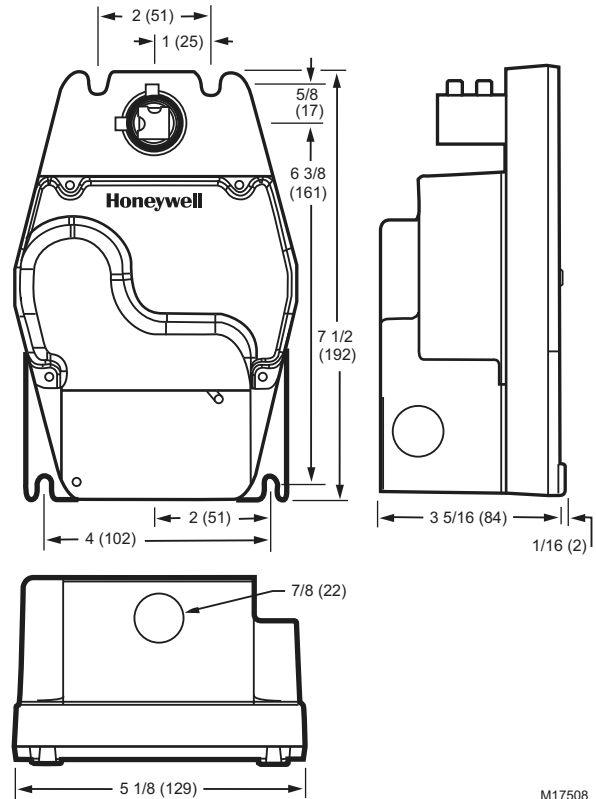

M17508

Fig. 1. MS4209/MS4309/MS4709/MS4809/MS8209/MS8309 dimensional drawing in inches (mm).

INSTALLATION

When Installing this Product...

1. Read these instructions carefully. Failure to follow them could damage the product or cause a hazardous condition.
2. Check the ratings given in the instructions and on the product to make sure the product is suitable for your application.
3. Installer must be a trained, experienced service technician.
4. After installation is complete, check out product operation as provided in these instructions.

IMPORTANT

All wiring must agree with applicable codes, ordinances and regulations.

WARNING

Electrical Power Hazard.

Line voltage can cause death or serious injury and short equipment circuitry.



Disconnect power supply before installation.

CAUTION

Electrical Shock or Equipment Damage Hazard.
Low voltage can shock individuals or short equipment circuitry.

Disconnect power supply before installation.

Location and Mounting

MS4209, MS4309, MS4709, MS4809, MS8209 and MS8309 DCA are designed to open a damper by driving the damper shaft in either the clockwise  or counterclockwise  direction. The actuator housing has two slots on the bottom that, with a 205649 Mounting Bracket, secure it flush to a damper box (see Fig. 2). When mounted correctly, these slots allow the actuator to *float* without rotating relative to the damper shaft.

CAUTION

Equipment Damage Hazard.
Tightly securing actuator to damper housing can damage actuator.
Mount actuator to allow it to float along its vertical axis.

NOTE: MS4209, MS4309, MS4709, MS4809, MS8209, and MS8309 Actuators are shipped in the fully closed position.

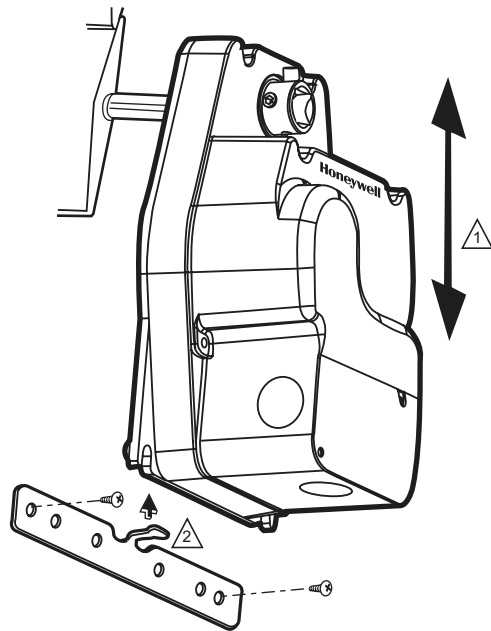

- 1 ENSURE THAT MOUNTING ASSEMBLY PREVENTS ACTUATOR ROTATION AND ALLOWS ACTUATOR TO FLOAT ALONG INDICATED AXIS. WHEN TOO TIGHT, THE RESULTING BINDING CAN DAMAGE THE ACTUATOR OR REDUCE TORQUE OUTPUT.
- 2 ACCESSORY MOUNTING BRACKET IS NOT SUPPLIED WITH THE ACTUATOR.

Fig. 2. Mounting actuator to damper housing.

Preparation

Before mounting the actuator onto the damper shaft, determine the damper shaft size (3/8 in. to 1/2 in. [10 mm to 13 mm]).

If the damper shaft is 3/8 in. (10 mm) round or square, use part number 201391 Shaft Adapter (*not supplied with actuator*). Place adapter opposite set screws (see Fig. 3).

NOTE: The damper shaft adapter centers a 3/8 in. (10 mm) damper shaft in the hub. Failure to use adapter can cause mounting screws to loosen. A 1/2 in. (13 mm) damper shaft does not require an adapter.

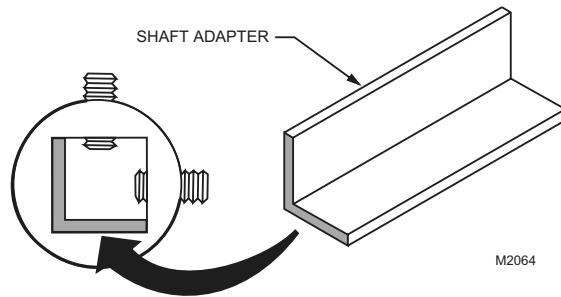

Fig. 3. Using damper shaft adapter for 3/8 in. (10 mm) damper shafts.

Installation

CAUTION

Device Malfunction Hazard.
Improper set screw tightening causes device malfunction.
Tighten set screws with proper torque to prevent damper shaft slippage.

CAUTION

Actuator Damage Hazard.
Using actuator as shaft bearing causes device damage.
Use actuator only to supply rotational torque. Avoid any side loads to actuator output coupling bearings.

To install actuator, proceed as follows:

1. Place actuator over damper shaft; and hold mounting bracket in place. See Fig. 2.
2. Mark screw holes on damper housing.
3. Remove actuator and mounting bracket.
4. Drill or center-punch holes for mounting screws (or use no.10 self-tapping sheet metal screws).
5. Turn damper blades to desired normal (closed) position.
6. Place actuator and mounting bracket back into position and secure bracket to damper box with sheet metal screws.
7. Tighten set screws securely into damper shaft using minimum 30 lb-in., maximum 60 lb-in. torque. Use 1/8 in. or 3 mm Allen wrench (see Specifications for details) to tighten set screws.

Wiring

See Fig. 4 through 6 for typical wiring diagrams.

! WARNING

Electrical Power Hazard.
Line voltage can cause death or serious injury and short equipment circuitry.
Disconnect power supply before installation.

! CAUTION

Electrical Shock or Equipment Damage Hazard.
Low voltage can shock individuals or short equipment circuitry.
Disconnect power supply before installation.

IMPORTANT

1. All wiring must comply with local electrical codes, ordinances and regulations.
2. Voltage and frequency of the transformer used with either the MS8209 or the MS8309 must correspond with the characteristics of both the power supply and the actuator.
3. Use wires rated for at least 75°C (167°F).

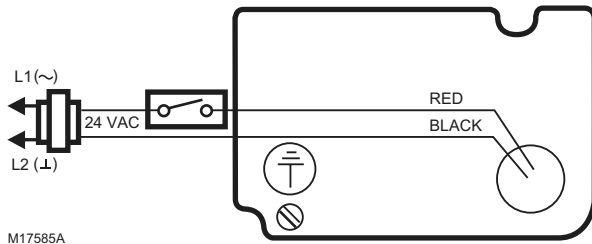

Fig. 4. Typical 24 Vac wiring.

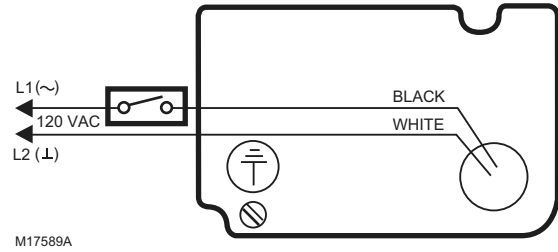

Fig. 5. Typical 120 Vac wiring.

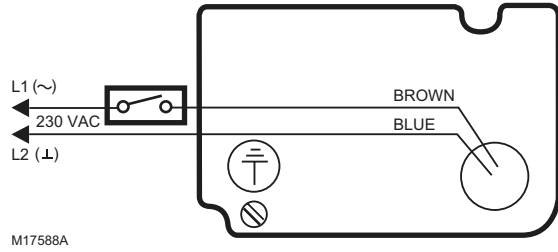

Fig. 6. Typical 230 Vac wiring.

OPERATION

The MS4209, MS4309, MS4709, MS4809, MS8209, and MS8309 DCA are designed for use in Smoke Control Systems. If power fails, the actuator spring returns to the 0° position. The actuator mounts flush with the damper box. The actuator drives from 0° to 95° and spring returns back to 0°.

The actuators are operated by an spst two-position controller. When using an spst two-position controller, the actuator drives to the damper fully open position when controller contact makes and spring returns to the damper fully closed position when controller contact breaks. The actuator drops to holding power level on detection of stall, independent of hub position.

Cycling

The actuator and the internal spring are designed so that no special cycling during long-term holding is required. Honeywell recommends following all local, state, and national codes for periodic testing of the entire smoke control system. Refer to National Fire Protection Association (NFPA) National Fire Codes®: NFPA90A, NFPA92A, and NFPA92B for your application.

CHECKOUT

MS4209F and MS4309F (120 Vac models)

1. Check damper position.
2. Connect 120 Vac to the black and white leadwires to drive the damper to the open position. The actuator should drive the damper.
3. If the actuator does not run, remove power for at least two seconds.
4. If the actuator spring returns, allow it to close entirely, then return to step 2.
5. If the actuator does not spring return, verify that the actuator is properly installed. See Installation section.
6. If the actuator is correctly installed but neither runs nor spring returns, replace the actuator.

MS4709F and MS4809F (230 Vac models)

1. Check damper position.
2. Connect 230 Vac to the blue and brown leadwires to drive the damper to the open position. The actuator should drive the damper.

3. If the actuator does not run, remove power for at least two seconds.
4. If the actuator spring returns, allow it to close entirely, then return to step 2.
5. If the actuator does not spring return, verify that the actuator is properly installed. See Installation section.
6. If the actuator is correctly installed but neither runs nor spring returns, replace the actuator.

MS8209F and MS8309F (24 Vac models)

1. Check damper position.
2. Connect 24 Vac to the red and black leadwires to drive the damper to the open position. The actuator should drive the damper.
3. If the actuator does not run, remove power for at least two seconds.
4. If the actuator spring returns, allow it to close entirely, then return to step 2.
5. If the actuator does not spring return, verify that the actuator is properly installed. See Installation section.
6. If the actuator is correctly installed but neither runs nor spring returns, replace the actuator.

- D Montageanweisung
- F Instructions d'Installation
- I Istruzioni per l'Installazione
- NL Installatievoorschrift
- DK Installasjonsinstruks
- N Installationsinstruktioner
- SF Asennusohje
- S Installations Instruktioner
- E Instrucciones de montaje

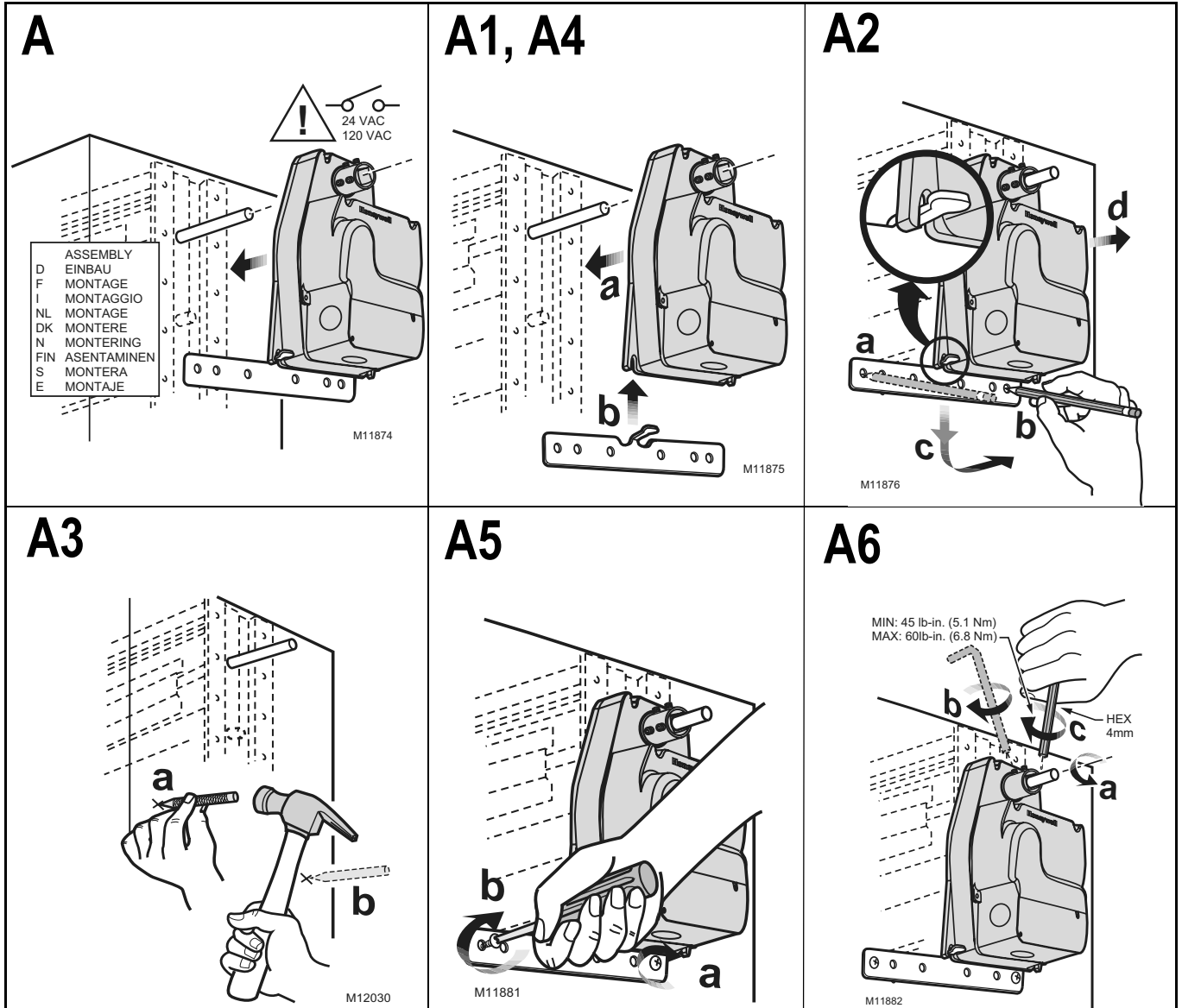

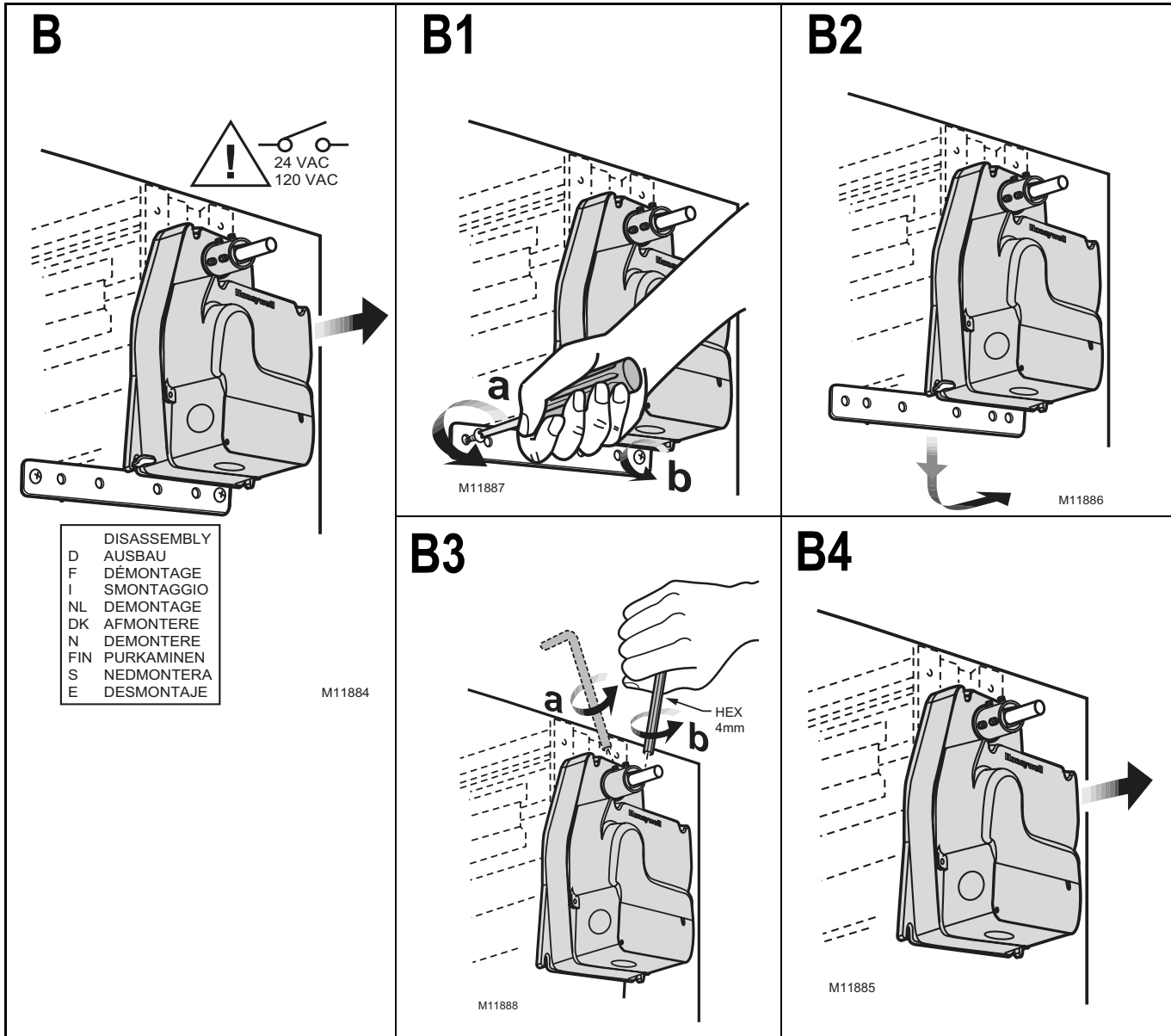

National Fire Codes® is a registered trademark of the National Fire Protection Association (NFPA).

Automation and Control Solutions

Honeywell International Inc.
1985 Douglas Drive North
Golden Valley, MN 55422
customer.honeywell.com

Honeywell Limited-Honeywell Limitée
35 Dynamic Drive
Toronto, Ontario M1V 4Z9

® U.S. Registered Trademark
© 2007 Honeywell International Inc.
63-2578—6 C.H. Rev. 04-07

Printed in U.S.A. on recycled paper containing at least 10% post-consumer paper fibers.

Honeywell