

Wireless Repeater for TB7200/7300/7600 Series Wireless Thermostats

INSTALLATION INSTRUCTIONS



APPLICATION

The TB-RP5000W ZigBee® wireless repeater is designed for use with Honeywell TB7200, TB7300, and TB7600 Series wireless thermostats.

The repeater is a low cost communication component for use when some remote thermostats are too far from the main mesh of a Honeywell device cluster and cannot communication with a WEBS AX controller with a wireless communication card (TB-VWG-APP-1014).

The additional repeater(s) will enable the remote thermostat(s) to establish communication and will act as bridge(s) to the main mesh.

The repeater(s) can typically be installed where most convenient. Either on a wall or even in a suspended ceiling space if required.

More Information

We recommend downloading the integration reference document and if installing thermostats with occupancy sensor covers, then also downloading the PIR Application Guide before you begin installation. All documentation is available on <http://customer.honeywell.com>.

- Wireless Installation and Integration Reference Guide for TB7200, TB7300, and TB7600 Thermostats (Form No. 63-4522).
- PIR Application Guide for TB7200 and TB7300 Series Thermostats (Form No. 63-4526).
- PIR Application Guide for TB7600 Series Thermostats (Form No. 63-4525).

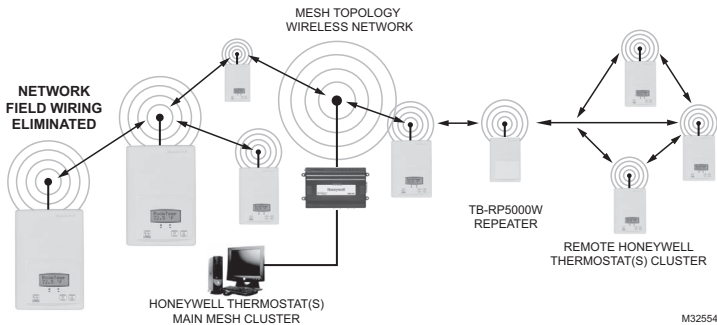

Fig. 1. Typical application for a TB-RP5000W



INSTALLATION

⚠ CAUTION

- Electronic controls are static sensitive devices. Discharge yourself properly before manipulation and installing the Repeater.
- Short circuit or wrong wiring may permanently damage the thermostat or the equipment.

Mounting Guidelines

- Wall surface must be flat and clean.

Repeater Installation

1. Open up by pulling on the bottom side of Repeater. (Fig. 2)
2. Remove wiring terminals.
3. Open the Repeater PCB to the left by pressing the PCB retaining tabs. (Fig. 3)
4. Pull cables 6 inches out of the wall.
5. Thread cable through the central hole of the base.

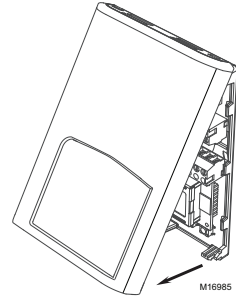

Fig. 2. Removing cover.

6. Align the base and mark the location of the two mounting holes on the wall. Install proper side of base up.
7. Install anchors in the wall.
8. Insert screws through the mounting holes on each side of the base and mount base on wall. (Fig. 3)
9. Gently swing back the circuit board on the base and push on it until the tabs lock it.
10. Strip each wire 1/4 inch.

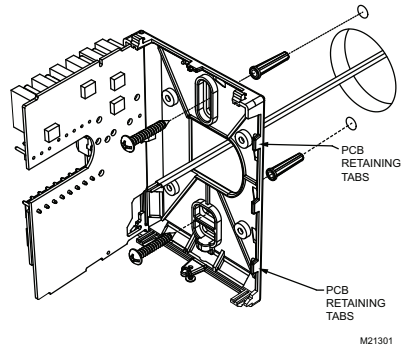

Fig. 3. Location of PCB retaining tabs and mounting screws.

11. Insert wires for 24 Vac power into terminals.
12. Gently push back excess cable into hole.
13. Install wiring terminal block. (Fig. 4)
14. Reinstall the cover (top first).
15. Install security screw.

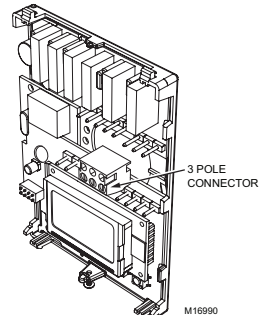

Fig. 4. Re-install terminal block.

BASIC INITIAL DESIGN AND DEPLOYMENT CONSIDERATIONS

Proper design considerations need to be addressed prior to any installation of a WEBS-AX controller with a the wireless communication card (TB-VWG-APP-1014) and related wireless thermostats.

1. To properly avoid network interference with 802.11 Wi-Fi devices in the 2.4GHz spectrum range, Honeywell recommends the use of 802.15.4 channels 15 or 25 only. 802.11 Wi-Fi transmissions overlap and may interfere with other channel selection allowed by 802.15.4 (Channels 11 to 26).
2. Maximum distance between each node (thermostat or repeater) should be:
 - Clear line of sight distance between 2 nodes should be under 100 feet (30M)
 - Non-line of sight distance for typical drywall partitions made with metal stud frame should be under 30 feet (10M)
3. Ensure that the minimum distance between any Honeywell ZigBee node and any Wi-Fi devices (wireless routers, wireless adapters, lap-tops using wireless networks, etc.) is at least 3 feet (1 M) and preferably 10 feet (3 M) or more.
4. Ensure that at least one thermostat is within 30 feet of the WEBS-AX controller with wireless communication card for every cluster of 10 thermostats installed.
5. Always try to locate the WEBS-AX controller near the center of all associated wireless thermostats, if possible.
6. Always try to locate the WEBS-AX controller near or in line of sight to as many wireless thermostats as possible.
7. Try to avoid metal, brick walls or concrete obstructions between wireless devices as much as possible.
8. Make sure the antenna on the WEBS-AX controller is always perpendicular to the floor.
9. Avoid placing the WEBS-AX controller and thermostats near metal or enclosed in metal boxes. If the WEBS-AX controller needs to be installed inside a metal cabinet, use the remote antenna accessory (TB-RA-1014).

TB-RP5000W Deployment Considerations

When Honeywell wireless thermostat cannot be discovered or added to a WEBS-AX controller database due to distance, the use of repeaters to bridge communication back to the WEBS-AX controller is necessary.

The number of repeater(s) necessary depends on how many devices are not able to join the WEBS-AX controller and how they are organized and distanced from each other.

- Clear line of sight distance between 2 nodes should be under 100 feet (30 M)
- Non line of sight distance for typical wall gypsum partitions made with metal stud frame should be under 30 feet (10M)

If a single thermostat is too far away and cannot join the main network a single repeater may be used (Fig. 5).

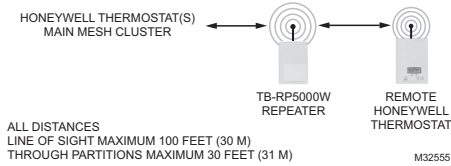

Fig. 5. Single remote thermostat

If a single thermostat is too far away and cannot join the main network with a single repeater, multiple repeaters can be used to increase the covered communication distance to the required coverage expected (Fig. 6).

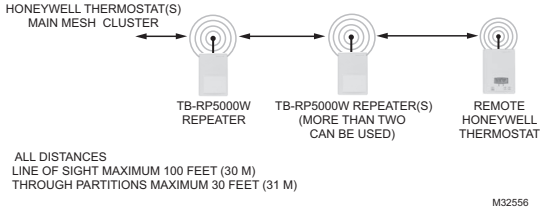

Fig. 6. Single remote thermostat with multiple repeaters

If two or more thermostats are too far away and cannot join the main network a single repeater may be used as long as the cluster of devices are at recommended distances for the main network deployment (Fig. 7).

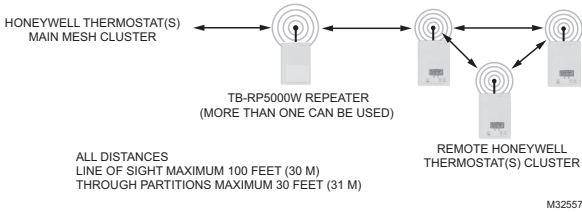

Fig. 7. Two or more remote thermostats

REPEATER STATUS LED

IMPORTANT

Be sure all thermostats/repeaters connected to a WEBS-AX controller have the same **PAN ID** and **Channel** as the WEBS-AX wireless communication card (TB-VWG-APP-1014).

Table 1. Repeater Wireless Adapter LED Status Indicators

1 x 200ms short blink	Power on
2 x 200ms short blinks	Power on and adapter communicating with repeater base
3 x 200ms short blinks	Power on, adapter communicating with repeater base and there is connectivity to wireless network
4 x 200ms short blinks	Power on, adapter communicating with repeater base, connectivity to wireless network and WEBS-AX controller is communicating with wireless repeater
4 x 200ms short blinks and 1 x 1500ms long blink	Power on, adapter communicating with repeater base, connectivity to wireless network and WEBS-AX controller is communicating with wireless repeater

Table 2. System Troubleshooting Recommendations

1.	If a repeater is not detected by the WEBS-AX controller, verify that the LED is blinking at least 4 times. If it is only blinking twice, ensure that the PAN ID and Channel of the thermostat and repeater are the same as the WEBS-AX controller it must communicate with.
2.	When commissioning a network, use channels 15 or 25. Alternate these channels between floors.
3.	If a particular repeater or thermostat refuses to join the network and cannot be seen by the WEBS-AX controller, move the device closer to the WEBS-AX controller until it has joined the network and it is added to the database. It can then be re-located to its original position.

STATUS DISPLAY INSTRUCTIONS

The repeater features a two-line, eight-character display.

When left unattended after configuration, the repeater will display its currently assigned communication address.

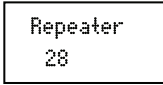

M16986

INSTALLER CONFIGURATION PARAMETER MENU

Local configuration:

1. Remove the repeater cover.
2. To enter configuration mode, press and hold the left button for 8 seconds.
3. Press the left button repeatedly to scroll between all the available parameters.
4. Use the (up/right) and (down/middle/center) key to change the parameter to the desired value.
5. To acknowledge and save the new value, press the Left button again.
6. The next listed parameter is now displayed.

Table 3. Configuration Buttons Interface

Left	<ul style="list-style-type: none"> • Enters the configuration mode. Press and hold for 8 seconds • Pressing repetitively will scroll all available parameters one by one
Middle/Center	Adjust/rotate parameter value down
Right	Adjust/rotate parameter value up

Table 4. Configuration Parameters

Configuration parameters	Default value	Significance and adjustments
Com Addr	Repeater networking address Default value = 254 Range is: 0 to 254	Valid range is 0 to 254. Each device on the network must have a unique com address.
PAN ID	Personal Area Network Identification Default value = 0 Range is: 0 to 500	This parameter is used to link specific thermostats or repeaters to a single specific Honeywell WEBs controller with a wireless communication card. For every thermostat or repeater reporting to a wireless communication card be sure you set the SAME PAN ID value both at the gateway and the wireless device(s). The default value of 0 is NOT a valid PAN ID. The valid range of available PAN ID is from 1 to 500
Channel	Channel selection Default value = 10 Set to: 15 or 25 Range is: 10 to 26	This parameter is used to link specific thermostats or repeaters to specific Honeywell wireless communication card. For every thermostat or repeater reporting to a Honeywell WEBs controller with a wireless communication card be sure you set the SAME channel value both at the gateway and the wireless device(s). Honeywell recommends using only the following channels: 15 or 25. The default value of 10 is NOT a valid channel. Although the valid range of available channels is from 11 to 26 use only channel 15 or 25 to avoid interference with other wireless devices.

SPECIFICATIONS

Thermostat Compatibility: TB7200, TB7300, and TB7600 Series wireless thermostats

Network Protocol: ZigBee wireless mesh

WEBS-AX Controllers: Compatible with WEB-2xx, WEB-6xx, and WEB-7xx

Platform:

WEB-2xx and WEB-6xx - WEBStation-AX 3.0 or later
 WEB-7xx - WEBStation-AX 3.5 or later

Repeater power requirements: 19-30 Vac 50 or 60 Hz; 2 VA Class 2

Operating conditions:

0 C to 50 C (32 F to 122 F)
 0% to 95% R.H. non-condensing

Storage conditions:

-30 C to 50 C (-22 F to 122 F)
 0% to 95% R.H. non-condensing

Wire gauge: 18 gauge maximum, 22 gauge recommended

Dimensions: See Fig. 8

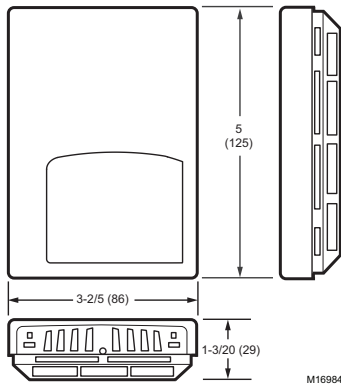

Fig. 8. Dimensions in inches (mm).

Approximate shipping weight: 0.75 lb (0.34 kg)

Agency Approvals all models:

UL: 873 (US) and **CSA** C22.2 No. 24 (Canada), File E27734 with CCN XAPX (US) and XAPX7 (Canada)

Industry Canada: ICES-003 (Canada)

FCC: Compliant to CFR 47, Part 15, Subpart B, Class A (US); Compliant to Part 15, Subpart C

This device complies with part 15 of the FCC rules. Operation is subject to the following two conditions: (1) this device may not cause harmful interference, and (2) this device must accept any interference received, including interference that may cause undesired operation.

CE: EMC Directive 89/336/EEC (Europe Union)

C-Tick: EN55022:2006, IEC 61326-1:2005

Automation and Control Solutions

Honeywell International Inc.

1985 Douglas Drive North

Golden Valley, MN 55422

customer.honeywell.com

© U.S. Registered Trademark
© 2011 Honeywell International Inc.
62-2022—03 M.S. Rev. 09-11
Printed in United States

Honeywell