

T775U Series 2000 Electronic Stand-Alone Controller

INSTALLATION INSTRUCTIONS

PRODUCT DESCRIPTION



The T775 electronic stand-alone controllers are the next generation of universal controls capable of remote sensing of temperature, humidity, pressure, etc. and providing switched and proportional outputs to various types of loads. A built-in time clock is standard.

The T775U controller allows a wide range of sensors to be configured. Humidity, pressure, temperature, or any 0-5 Vdc, 0-10 Vdc, or 4-20 mA input is supported.

A Reset function is available where the Sensor B temperature (e.g. outside temperature) is used to provide reset control for Sensor A (e.g. humidity). For example, as the outside temperature gets colder, the setpoint can automatically be adjusted to prevent condensation.

IMPORTANT

The T775U is an operating control, not a limit or safety control. If used in applications requiring safety or limit controls, a separate safety or limit control device is required.

Table 1. T775U Controller Configurations.

Controller Model ^a	Description	Replaces	Output Reset	SPDT Relay Outputs	Analog (Mod) Outputs ^b	Sensor Inputs	Nbr of Sensors Included	Enclosure
T775U2006	Universal: Humidity, Pressure, Temperature, etc.	H775A1006 H775A1022 H775A1048 H775A1063 H775B1005 H775C1004 ^c H775D1003 ^c H775E1002 ^c	Yes	2	2	2 ^d	None	NEMA 1
T775U2016		N/A	Yes	2	2	2 ^e	None	NEMA 1

^a The T775U includes a digital input for use with the disable or setback option.

^b The modulating (analog) outputs may be 4-20 mA, 0-10 Vdc, 2-10 Vdc, or Series 90 selectable.

^c For the H775C1004, H775D1003, and H775E1002 model replacement, the T775U only partially replaces the function of these devices. Check application for suitability.

^d For the sensor inputs, Sensor A can be 0-10Vdc, 4-20mA, or a standard temperature input. Sensor B is a standard temperature sensor input only. Sensor B is used only for reset on the T775U2006.

^e The T775U2016 can control Sensor A (universal) and Sensor B (temperature) independently, like other standard T775 controllers.



Temperature Sensors^a (Sensor A or B)

The controller accepts 1,097 Ohms PTC at 77°F (25°C):

- 50021579-001 – Standard sensor (included with all models except NEMA 4X models)
- T775-SENS-WR – Water resistant with 5 foot leads (included with NEMA 4X models)
- T775-SENS-WT – Watertight with 6 foot lead
- T775-SENS-OAT – Outdoor air temperature sensor
- C7031D2003 – 5 inch immersion sensor with wiring box (use immersion well; P/N 50001774-001)
- C7031J2009 – 12 foot duct averaging sensor with wiring box
- C7046D1008 – 8 inch duct probe with mounting flange
- C7100D1001 – 12 inch fast response, duct averaging sensor with flange
- C7130B1009 – Room mount sensor

Differential Pressure Sensors

(Sensor A only)

P7640A and PWT pressure transducer models with selectable pressure ranges can be used.

The controller accepts pressure sensors with a signal output of 0-10 Vdc or 4-20 mA for any output range within the following ranges (the minimum and maximum for the sensor output range can be adjusted within the following limits):

- -500 to 500 PSI
- -30.0 to 30.0 inches w.c.
- -3,000 to 3,000 Pa
- -3,000 to 3,000 kPa

Humidity Sensors (Sensor A only)

The controller accepts 0-10 Vdc or 4-20 mA input with a range of 0-100%.

H7625, H7635, and H7655 models (available in 2, 3, and 5% RH accuracy) can be used.

CO₂ Sensors

The controller accepts a 0-10 Vdc or 4-20 mA input from C7232 and C7632 CO₂ sensors and is settable in PPM units.

Universal Sensors (Sensor A only)

The controller accepts 0-5 Vdc, 0-10 Vdc or 4-20 mA input for temperature, pressure, humidity CO₂, etc. They may be programmed in units of °F, °C, %, Pa, kPa, PSI, In W.C., PPM, or may be unitless (none).

The PPM range is 0 to 9990.

Choosing none for units, results in no units being displayed on the home screen. If no unit is specified the range is -9999 to +9999.

Actuators

For more information on compatible actuators or other Honeywell products, such as dampers and valves, go to www.customer.honeywell.com. From the home page select **Product Selection Tool** under **Products**.

- Spring return models: ML6425, ML7425, MS4105, MS4110, MS4120, MS7505, MS7510, MS7520, MS8105, MS8110, MS8120
- Non-spring return models: ML4161, ML6174, ML7161, MN6105, MN1010, MN7505, ML7164, MN8810

Accessories

- 107324A – Bulb Holder, duct insertion
- 107408 – Heat Conductive Compound, 4 ounce
- 50001774-001 – Immersion Well, stainless steel 304, 1/2 in. threading

Product Changes

Below are the changes to T775U models starting with Series 3 (March 2009). Series 3 can be identified by the sideways 3 after the part number on the device label.

1. Setpoint and Enable options added to the DI options.
2. 0-5 Vdc sensor inputs are now available (for both models).
3. MIN ON time added.
4. HIDE option added to MOD1 and MOD2 (to hide them on the home screen).
5. PPM and None added to sensors' unit of measure.
6. With the new T775U2016 model, all outputs can be controlled to Sensor A or Sensor B. The T775U2006 model controls only to Sensor A.

^a See form 62-0265 – *Temperature Sensors for the T775 Series 2000 Stand-alone Controller*

Controller Dimensions

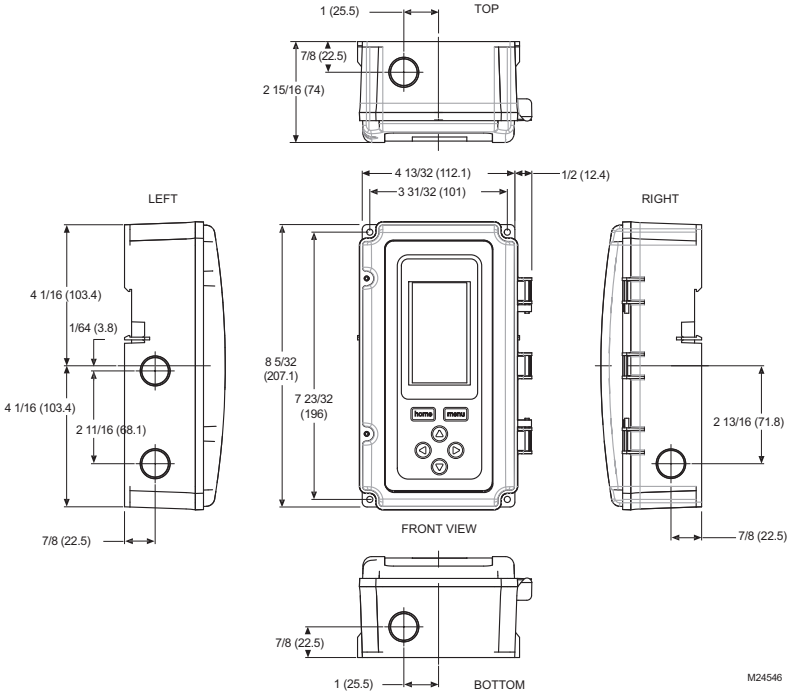

Fig. 1. T775U Dimensions in inches (mm).

BEFORE INSTALLATION

Review the “Specifications” on page 38 before installing the controller.

When Installing This Product

1. Read these instructions carefully. Failure to follow them could damage the product or cause a hazardous condition.
2. Check ratings given in instructions and on the product to ensure the product is suitable for your application.
3. Installer must be a trained, experienced service technician.
4. After installation is complete, check out product operation as provided in these instructions.

INSTALLATION AND SETUP

The following installation procedures are typically performed in the order listed:

1. Mounting — see “Mounting” below.
2. Wiring — see “Wiring” on this page.
3. Checkout — see page 10.
4. Interface and Programming overview — see page 11.
5. Setup — see page 14.

6. Programming the Controller with no Reset — see page 26 or Programming the Controller with Reset — page 29.
7. Scheduling (optional)— see page 34.

Additional topics are:

- Sensor calibration begins on page 11.
- Interface overview begins on page 11.
- Summary menu begins on page 38.
- Troubleshooting begins on page 38.

MOUNTING

This section describes the mounting procedures for the controller and temperature sensor(s).

Controller Mounting

IMPORTANT

Avoid mounting in areas where acid fumes or other deteriorating vapors can attack the metal parts of the controller circuit board, or in areas where escaping gas or other explosive vapors are present.

IMPORTANT

The controller must be mounted in a position that allows clearance for wiring, servicing, and removal.

Use a screwdriver to pry out only the knockouts that you will use.

If mounting on DIN rail, be sure to remove the knockouts before mounting. See “Controller Wiring” on page 7 and Fig. 12 on page 9 for recommended knockout usage and locations. If you do not use an opened knockout be sure to cover it.

Mount the controller on any convenient interior location using the four mounting holes provided on the back of the enclosure using #6 or #8 screws (screws are not provided and must be obtained separately). Use controller dimensions in Fig. 1 on page 3 as a guide.

The controller may be mounted in any orientation. However, mounting in the orientation shown in Fig. 1 on page 3 permits proper viewing of the LCD display and use of the keypad.

Humidity, Pressure, and Universal Sensor(s) Mounting and Location

These sensors may be mounted on a wall or panel. Follow the installation instructions specific to the sensor you are installing.

Temperature Sensor(s) Mounting and Location

Temperature sensors may be located up to 1,000 feet (304 m) from the T775U controller. See Table 4 on page 11 for calibration guidelines.

The sensors may be mounted on a wall or panel for sensing space temperature, strapped to a pipe or inserted in an immersion well (see Fig. 2) for hot or cold water sensing, or taped to a standard cap or bulb holder for duct air sensing. To prevent moisture or condensation entering the sensor through the lead wire holes, mount the sensor with the lead wires exiting the bottom of the sensor.

NOTES:

1. The included sensor is not designed for very wet applications. For immersion applications, an immersion well is used.
2. Heat conductive compound must be used in immersion wells.
3. See “Temperature Sensors (Sensor A or B)” on page 2 for this type of installation.

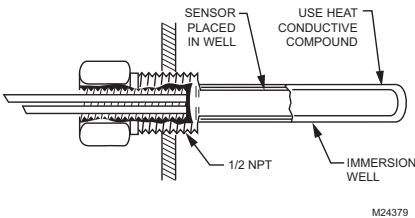

Fig. 2. Sensor inserted in immersion well.

NOTE: Multiple sensors may be parallel-series wired to sense average temperatures in large spaces. See Fig. 3 on page 5.

WIRING

All wiring must comply with applicable electrical codes and ordinances, or as specified on installation wiring diagrams. Controller wiring is terminated to the screw terminal blocks located inside the device.

The remainder of this section describes the sensor wiring and the T775U controller wiring.

Wiring Connections Access

To access the wiring connections, remove the two screws on the left side of the enclosure and gently swing open the top. Be careful to not stress the ribbon cables that connect the keypad and LCD display to the controller circuit board.

Temperature Sensor Wiring

! CAUTION

Electrical Shock Hazard.

Can short equipment circuitry.

Make sure that metal tube of sensor does not short against T terminals in wall-mounted case.

IMPORTANT

Poor wiring practices can cause erratic readings from the sensor. Avoid the following to ensure proper operation:

- Do not route the temperature sensor wiring with building power wiring.
- Do not locate the temperature sensor wiring next to control contactors.
- Do not locate the temperature sensor wiring near electrical motors.
- Do not locate the temperature sensor wiring near welding equipment.
- Make sure good mechanical connections are made to both the sensor and the controller.
- Do not mount the sensor with the lead wire end pointing up in an area where condensation can occur.

If any of the above conditions cannot be avoided, use shielded cable.

NOTE: Each T775 controller must be wired to its own sensor(s). However, a benefit of the T775 controller’s accuracy is that there is no more than a 2°F differential between any two T775 controllers.

Reset Temperature Control

If you are implementing two-sensor reset control, Sensor A must always be the controlled temperature and Sensor B must always be the controlling temperature.

For example, in a reset control based on outside temperature, Sensor A must be the inside sensor and Sensor B must be the outside sensor.

Multiple Parallel Temperature Sensors

Multiple sensors can be parallel-series wired to sense average temperatures in large spaces. To maintain control accuracy, the number of sensors to be parallel-series wired must be of the n^2 power (for example, 4, 9, 16, etc.). See Fig. 3.

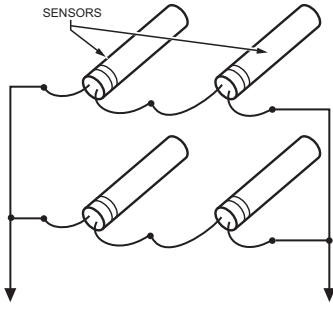

TO T775 CONNECTIONS (SENSOR A) OR (SENSOR B).
M24548

Fig. 3. Parallel-series wiring of sensors.

Temperature Sensor Wire Type and Size

Temperature sensors use standard AWG 18/2 unshielded wire. For cable runs greater than 25 feet or where electrical interference may be a problem, shielded cable is recommended. See Fig. 4.

Refer to "Temperature Sensor Calibration" on page 11 for wire size selection where cable runs are longer than 25 feet.

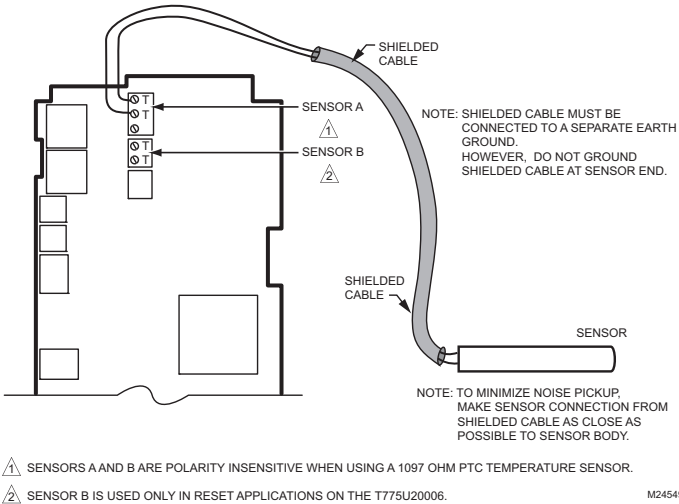

Fig. 4. Sensor Wiring — 2-wire shielded cable connection from Sensor A to temperature sensor.

Humidity, Pressure, and Universal Sensor Wiring

Sensors with a 0-5 Vdc, 0-10Vdc or 4-20mA input to the T775U must be wired to the Sensor A terminal. Sensor B is used only as a temperature input.

Sensors use standard AWG 18 unshielded wire. For cable runs greater than 25 feet, shielded cable is recommended.

The sensors in Fig. 5 – 8 beginning on page 6 are examples and illustrate voltage and current wiring for 3-wire and 2-wire sensors to the Sensor A terminal. For

terminal wiring details, see Fig. 11 and Table 2 on page 8. Other sensors are supported. See sensor descriptions on page 2.

NOTES:

1. Other transmitters can be wired in the same manner. For example, the 0-10Vdc wiring shown in Fig. 5 on page 6 with the H76XX sensor can also be done with the P7640 or any other transmitter.
2. The T775U V terminal outputs 18 Vdc.

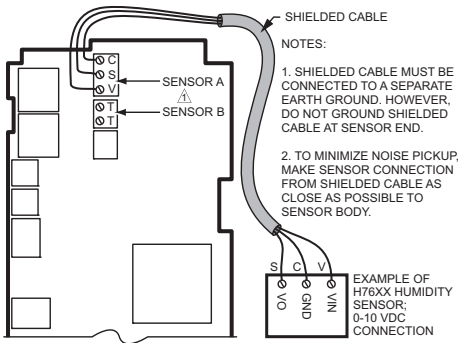

⚠ THE T775U WILL ONLY ACCEPT 0-10 VDC AND 4-20 MA SENSORS. IF REPLACING AN H775 CONTROLLER THAT USES A C7600B OR OTHER 2-10 VDC SENSOR, THE SENSOR MUST BE REPLACED. REPLACE THE C7600B/2008 SENSOR (2-10VDC OUTPUT) WITH THE H7655A1001 (0-10 VDC OUTPUT) SENSOR. THE H7655A1001 SENSOR USES THE SAME ENCLOSURE STYLING AND WIRING AS THE C7600B. M24550

Fig. 5. Sensor Wiring — 3-wire shielded cable connection from Sensor A to 0-10 Vdc sensor (H76xx humidity sensor shown).

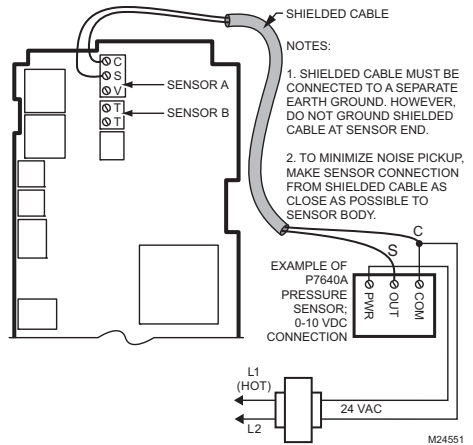

Fig. 7. Sensor Wiring — 2-wire shielded cable connection from Sensor A to a 0-10 Vdc sensor using separate transformer.

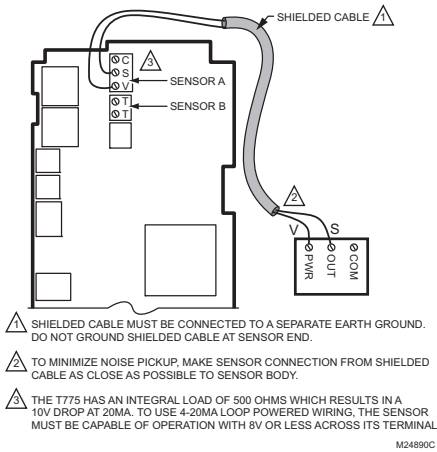

Fig. 6. Sensor Wiring — 2-wire shielded cable connection from 4-20 mA sensor to T775 controller (loop powered wiring).

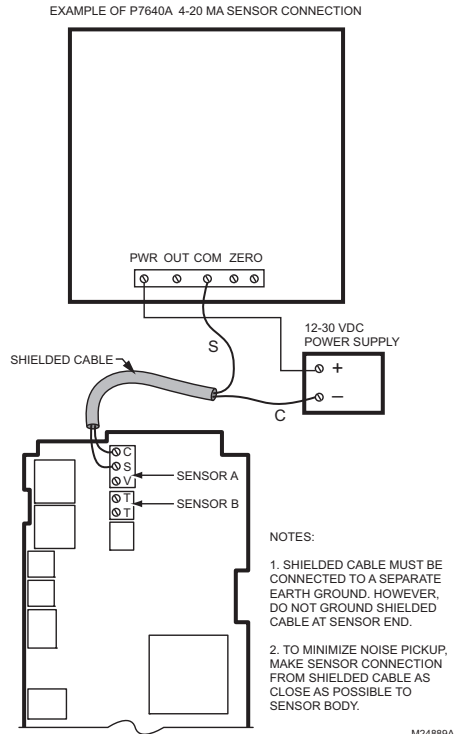

Fig. 8. Sensor Wiring — 2-wire 4-20mA sensor input to T775 controller using a separate (Vdc only) transformer.

Controller Wiring

! WARNING

Electrical Shock Hazard.
Can cause severe injury, death or property damage.

Disconnect power supply before beginning wiring, or making wiring connections, to prevent electrical shock or equipment damage.

! CAUTION

Do not use 24 Vac power to power any external loads if 120 Vac or 240 Vac is used to power the T775U.

! CAUTION

A separate earth ground is required. Equipment damage can result if the earth ground is not connected. See Fig. 9 and Table 2 on page 8.

! CAUTION

Equipment Damage Hazard.
Electrostatic discharge can short equipment circuitry.
Ensure that you are properly grounded before handling the unit.

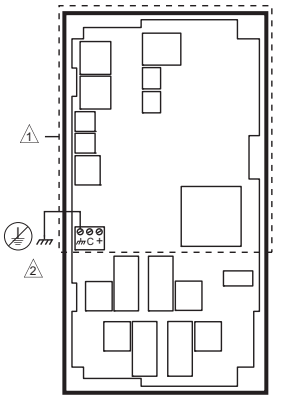

- ! NO HIGH VOLTAGE. CLASS 2 WIRING ONLY.**
- ! EARTH GROUND TERMINAL MUST BE CONNECTED TO CONDUIT CLAMP LOCALLY.**

M24296

Fig. 9. Earth Ground.

IMPORTANT

Poor wiring practices can cause erratic readings from the sensor. To ensure proper operation, ensure that good mechanical connections are made to both the sensor and the controller.

IMPORTANT

When wiring the input power, only one source of power can be applied to the T775U (24 Vac or 120 Vac or 240 Vac).

See Fig. 11 on page 8 for locating the appropriate power input, remote sensors input, low voltage, contact closure, and load output terminals.

Access to the terminals can be gained through standard conduit knockouts (A through E in Fig. 11 on page 8) located around the perimeter of the enclosure:

- Knockouts A and B should be used only for sensor and low-voltage wiring.
- Knockouts C, D, and E can be used to gain access to the load relay output terminals and 120/240 Vac power wiring.

Controller Wiring Method

Wire the sensors and outputs, then wire the power connection.

Each terminal can accommodate the following gauges of wire:

- Single wire – from 14 AWG to 22 AWG solid or stranded
- Multiple wires – up to two 22 AWG stranded

For 24, 120, or 240 Vac power connections:

Single wire – from 14 to 18 AWG solid or stranded

Using Fig. 10 on page 7 as a guide, prepare wiring for the terminal blocks, as follows:

1. Strip 1/2 in. (13 mm) insulation from the conductor.
2. Cut a single wire to 3/16 in. (5 mm). Insert the wire in the required terminal location and tighten the screw.
3. If two or more wires are being inserted into one terminal location, twist the wires together a minimum of three turns before inserting them to ensure proper electrical contact.
4. Cut the twisted end of the wires to 3/16 in. (5 mm) before inserting them into the terminal and tightening the screw.
5. Pull on each wire in all terminals to check for good mechanical connection.

1. STRIP 1/2 IN. (13 MM) FROM WIRES TO BE ATTACHED AT ONE TERMINAL.

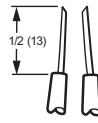

2. TWIST WIRES TOGETHER WITH PLIERS (A MINIMUM OF THREE TURNS).

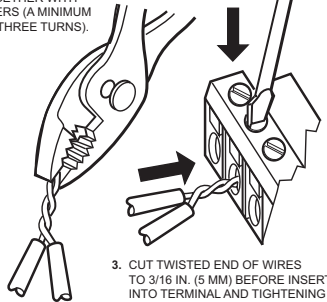

3. CUT TWISTED END OF WIRES TO 3/16 IN. (5 MM) BEFORE INSERTING INTO TERMINAL AND TIGHTENING SCREW. THEN PULL ON EACH WIRE IN ALL TERMINALS TO CHECK FOR GOOD MECHANICAL CONNECTION.

M24552

Fig. 10. Attaching two or more wires at terminal blocks.

Controller Wiring Details

The wiring connection terminals are shown in Fig. 11 and are described in Table 2. See Fig. 12 – Fig. 19 beginning on page 9 for typical T775U wiring applications.

Fig. 11. T775U Terminal and Feature Locations.

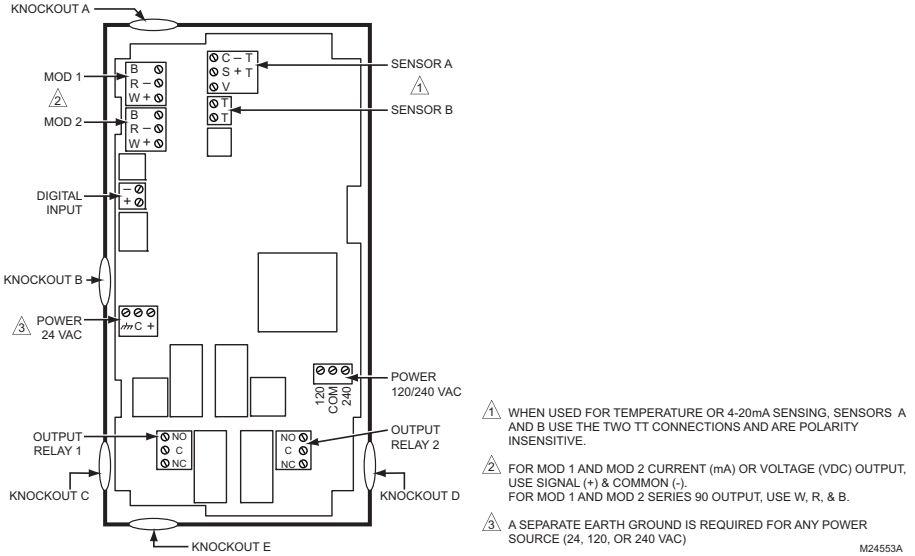

- ⚠ WHEN USED FOR TEMPERATURE OR 4-20mA SENSING, SENSORS A AND B USE THE TWO TT CONNECTIONS AND ARE POLARITY INSENSITIVE.
- ⚠ FOR MOD 1 AND MOD 2 CURRENT (mA) OR VOLTAGE (VDC) OUTPUT, USE SIGNAL (+) & COMMON (-). FOR MOD 1 AND MOD 2 SERIES 90 OUTPUT, USE W, R, & B.
- ⚠ A SEPARATE EARTH GROUND IS REQUIRED FOR ANY POWER SOURCE (24, 120, OR 240 VAC)

M24553A

Table 2. Description of Wiring Terminal Connections.

Connection	Terminal Label	Description	Connection	Terminal Label	Description
Sensors			Outputs		
Sensor A ^a	C – common S – signal V – voltage	0-10 Vdc input: Universal sensor for humidity, pressure, temperature, etc.	Mod 1	+ - (Vdc or mA)	Modulating Output
	S and V	4-20mA input; see Fig. 7 on page 6	Mod 2	W R B (Series 90) ^b	
	T T	Temperature Sensor; polarity insensitive	24 Vac Power		
Sensor B	T T	Temperature Sensor; polarity insensitive	24V +	+	24 Vac Hot
Input			Common	-	24 Vac Common
DI	+ -	Digital Input (dry contact)	Ground	⏏	Earth Ground ^c
Outputs			120 or 240 Vac Power		
Relay 1	NO / COM /	120-240 Vac Relay Output	120 Vac		120 Vac Power
Relay 2	NC		Common	COM	Common
			240 Vac	240	240 Vac Power

^a For applications that do not use Reset, only Sensor A is available for use.
^b For Series 90 connections, you must insert a 340 Ohm resistor across terminals R and W. See Fig. 18 on page 10. The resistor is included with the controller.
^c A separate earth ground is required for all installations regardless of the power source (24, 120, or 240 Vac).

WIRING APPLICATION EXAMPLES

Fig. 12 – 19 illustrate typical controller wiring for various applications.

NOTE: The electronic Series 90 output provided with modulating T775 models can not drive electro-mechanical slidewire devices like older Series 3 modulating meters (prior to Series 6), V9055s, and S984s.

NOTE: For a wiring example of three Series 90 Modutrol Motors, refer to the T775A/B/M Series 2000 Electronic Stand-alone Controllers Installation Instructions (form 62-0254).

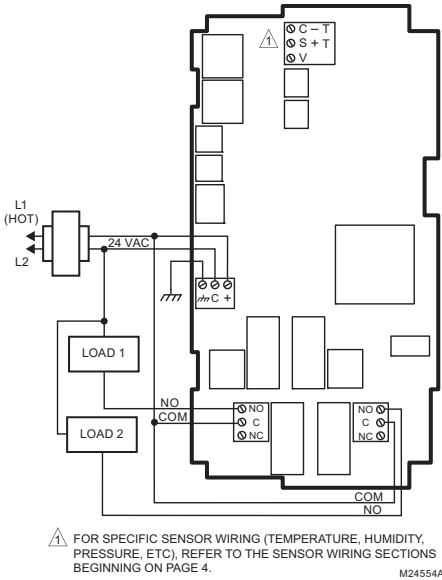

Fig. 12. Wiring for Two-stage Control – 24 Vac Input and 24 Vac Load.

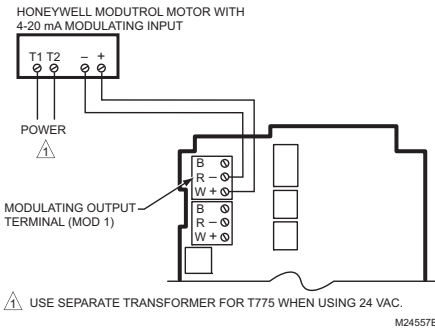

Fig. 13. Wiring for mod motor or direct coupled actuator with 4 to 20 mA control input.

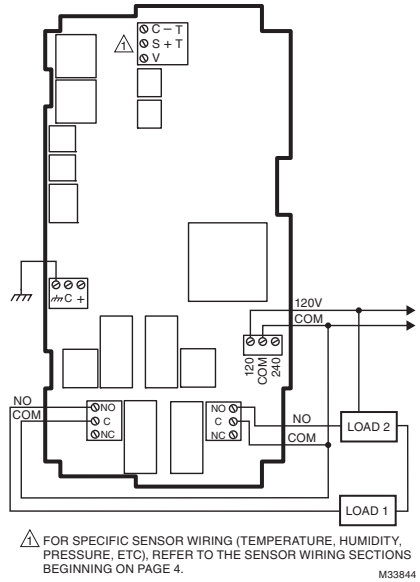

Fig. 14. Wiring for Two-stage Control with 120 Vac (120 Vac Input and 120 Vac Load).

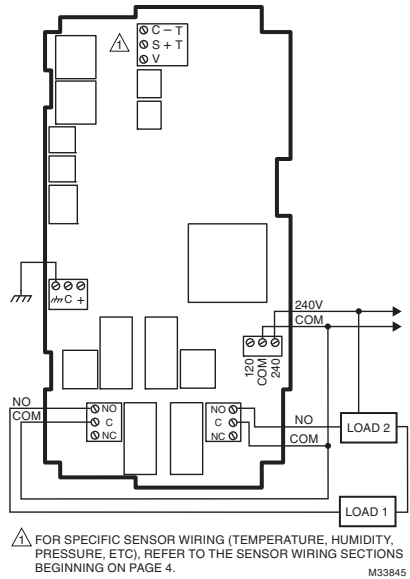

Fig. 15. Wiring for Two-stage Control with 240 Vac.

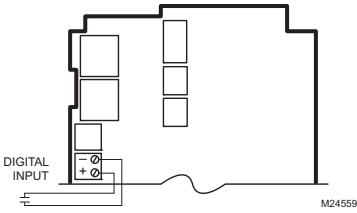

Fig. 16. Wiring for Digital Input (dry contact).

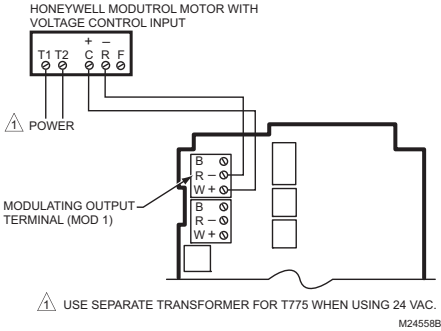
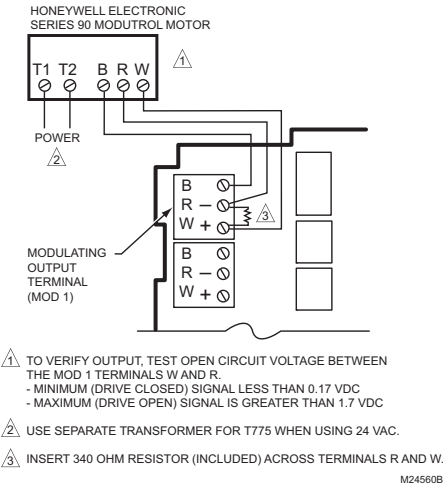
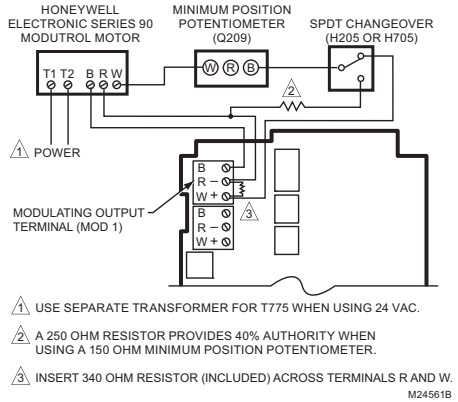

Fig. 17. Wiring for mod motor or direct coupled actuator with 0-10 Vdc control input.



- ⚠ TO VERIFY OUTPUT, TEST OPEN CIRCUIT VOLTAGE BETWEEN THE MOD 1 TERMINALS W AND R.
 - MINIMUM (DRIVE CLOSED) SIGNAL LESS THAN 0.17 VDC
 - MAXIMUM (DRIVE OPEN) SIGNAL IS GREATER THAN 1.7 VDC
- ⚠ USE SEPARATE TRANSFORMER FOR T775 WHEN USING 24 VAC.
- ⚠ INSERT 340 OHM RESISTOR (INCLUDED) ACROSS TERMINALS R AND W.

Fig. 18. Wiring for Series 90 Modutrol Motor Control.



- ⚠ USE SEPARATE TRANSFORMER FOR T775 WHEN USING 24 VAC.
- ⚠ A 250 OHM RESISTOR PROVIDES 40% AUTHORITY WHEN USING A 150 OHM MINIMUM POSITION POTENTIOMETER.
- ⚠ INSERT 340 OHM RESISTOR (INCLUDED) ACROSS TERMINALS R AND W.

Fig. 19. Wiring for Changeover Relay and Minimum Position Potentiometer used with Series 90 Modutrol Motors.

CHECKOUT

Inspect all wiring connections at the controller terminals, and verify compliance with the installation wiring diagrams.

⚠ WARNING

Electrical Shock Hazard.
Can cause severe injury, death or property damage.
 Disconnect power supply before beginning wiring or making wiring connections, to prevent electrical shock or equipment damage.

If any wiring changes are required, *first* be sure to remove power from the controller *before* starting work. Pay particular attention to verifying the power connection (24, 120, or 240 Vac).

After the controller is mounted and wired, apply power.

Power Loss

The date and time settings are retained for 24 hours after a power outage. After a power loss of more than 24 hours, the date and time settings may need to be reentered. All other settings are stored permanently.

Humidity, Pressure, and Universal Sensor Calibration

A calibration parameter is available using Setup mode. The calibration range is +/- 10% of the Min Value to Max Value range setup for the sensor. See examples in Table 3.

Table 3. Calibration Range Examples.

Units	Min. Value Example	Max. Value Example	Min-Max Range Result	Calibration Range
PSI	100	400	300	± 30 PSI
Inches W.C.	-20.0	20.0	40	± 4 in. W.C.
Pa or kPa	-2,000	3000	5000	± 500 Pa/kPa
%	10	100	90	± 9%

The calibration value is set in section "1.2.2.3. CALIBRATE (Sensor A or B)" on page 17.

Temperature Sensor Calibration

As wire length increases, resistance increases and thus the temperature reading increases. If necessary, calibrate the sensor input by reducing the value by the amount shown in the Table 4 on page 11. For example, a wire run with 18 gauge wire of 1,000 feet, requires a calibration offset of -6.0°F.

IMPORTANT

If the calibration value in the table exceeds the controller's calibration limits of +/-10°F (+/-6°C), you must use a heavier gauge wire.

For example, with a wire run of 1,000 feet you must use 20 AWG wire or heavier in order to calibrate for wire loss within the limits of the controller.

See "1.2.2.3. CALIBRATE (Sensor A or B)" on page 17 for the instructions to enter the calibration value.

NOTE: The resistance output on the temperature sensors change at the rate of 2.2 Ohms per °F (3.85 Ohms per °C).

Table 4. Temperature Sensor Calibration for Resistance Loss due to Wire Length.

AWG Rating	m□/ft	Temperature Offset in °F (Feet) ^a		
		200 ft	500 ft	1,000 ft
14	2.5	0.46	1.14	2.28
16	4.0	0.72	1.82	3.64
18	6.4	1.16	2.90	5.82
20	10.2	1.86	4.64	9.28

Table 4. Temperature Sensor Calibration for Resistance Loss due to Wire Length. (Continued)

AWG Rating	m□/ft	Temperature Offset in °F (Feet) ^a		
		200 ft	500 ft	1,000 ft
22	16.1	2.92	7.32	14.64

AWG Rating	m□/m	Temperature Offset in °C (Meter) ^a		
		100 m	200 m	300 m
14	8.3	0.44	0.86	1.30
16	13.2	0.68	1.38	2.06
18	21.0	1.10	2.18	3.28
20	33.5	1.74	3.48	5.22
22	52.8	2.74	5.48	8.22

^a This is the distance from the controller to the sensor (already accounts for round trip distance).

Fig. 20 shows how sensor resistance varies with temperature for a sensor having a positive temperature coefficient (PTC) of 2.1 Ohms per degree F (3.85 Ohms per degree C).

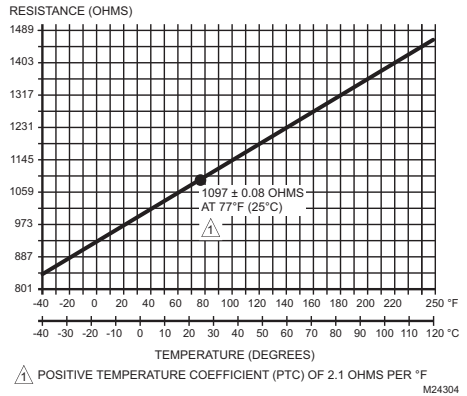

Fig. 20. Sensor Resistance vs. Temperature.

INTERFACE OVERVIEW

The T775U controller uses an LCD panel and 6-button keypad to provide status information and permit user input of the programming, setup, and scheduling parameters.

The following figure describes the display areas of the LCD and the keypad.

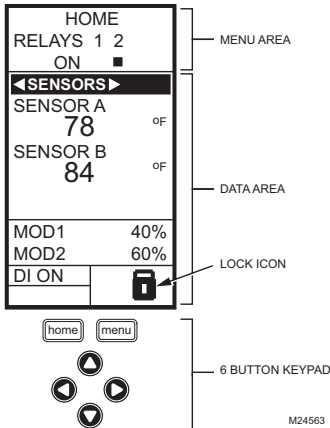

Fig. 21. LCD Display - Home Screen And Keypad.

Menu Area – On the home screen, the LCD displays the configured relays and whether they are active. In Program, Setup or Schedule mode, the LCD displays the current menu selection and its order within the menu hierarchy.

Data Area – On the home screen, the LCD displays the sensors and outputs status. In Setup or Program mode, the LCD displays menu choices, parameter selections, and data values.

Lock Icon – The icon indicates the MENU button is locked and prevents access to the Setup and Program menus.

NOTE: Pressing and holding the HOME and MENU buttons simultaneously for five seconds locks/unlocks the MENU button.

6-Button Keypad – The keypad is used to access the menus and enter values (see “Using the LCD Panel Interface”).

Using the LCD Panel Interface

The 6-button keypad is used to move through the menus and enter or change parameter values.

Home Button

Pressing the HOME button at any time exits the current Programming or Setup display screen and returns to the home screen as shown in Fig. 21 and Fig. 22.

Menu Button

- Pressing the MENU button always displays the Program menu. If you are in Setup mode, you exit setup and return to the Program menu.
- Pressing and holding the MENU button for five seconds leaves the current screen and displays the Setup menu.

Left and Right Arrow Buttons (t and u)

Use these buttons to move backward (t) and forward (u) through the Program and Setup menus.

Up and Down Arrow Buttons (p and q)

Use these buttons to move your selection up and down through a menu or list.

- When the desired item is highlighted, you press the u arrow button to display that item’s content.
- When a value is displayed (e.g. 70°F), the up and down arrows increase and decrease the value.

NOTE: Once you select an item from a list or enter a value, pressing the t or u or HOME button accepts your selection or value and stores it in the controller’s memory.

Home Screen

In the normal run state, the LCD home screen displays the current sensed temperatures, the modulating outputs status, the active status of the output relays, and error and status codes.

When using Reset, the Heat/Cool setpoint(s) display on the home screen for the Mod and Relay outputs; see Fig. 22.

Active relays are indicated by the small black square (e) just below the relay number. Fig. 22 shows the home screen with relay 2 energized.

Pressing the t and u buttons from the home screen cycles through each modulating output that is paired with the sensor it controls and the active output relays.

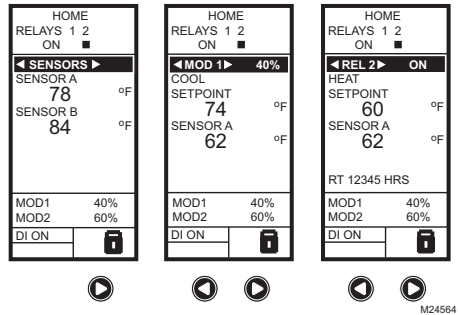

Fig. 22. LCD Display - Home Screen Displaying Sensors, Mod Outputs, and Active Relays.

NOTES:

- The modulating output home screen and the relay home screen do not dynamically update the active relay status, sensor values, and modulating output percentages. The information is a snapshot taken when you press the t or u button to display the screen.
- In Reset mode, the home screen displays the effective setpoint.

IMPORTANT

After four minutes of inactivity (no buttons pressed), the LCD display reverts to the home screen display.

Accessing the Menus

Menus are used for programming, scheduling, viewing the summary settings, and setup of advanced options.

Program, Schedule, and Summary Menus

To access these menus from the home screen, press the MENU button. See Fig. 23.

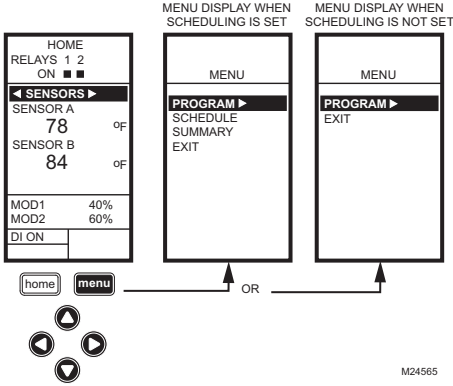

Fig. 23. Menus.

Depending on whether scheduling is enabled or not, the LCD displays one of two menus as shown in Fig. 23. Scheduling is enabled from the Setup menu's Output settings (see "1.3.3.1. USE SCHED" on page 22).

Setup Menu

To access the Setup menu, press and hold the MENU button for five seconds. See Fig. 24.

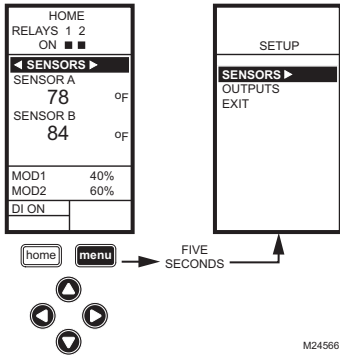

Fig. 24. Setup Menu.

Using the Menus

When you are working with the menus, use the:

- **Left arrow button** (t) to scroll backward through the menus
- **Right arrow button** (u) to select the highlighted menu item and display its content
- **Up and Down arrow buttons** (p and q) to scroll up and down through a list of items or to increase or decrease the value of a displayed parameter

NOTES:

1. If you press the **HOME** button or there is no keypad activity for four minutes, you exit Program mode and return to the home screen.
2. If you press the **MENU** button, you exit and return to the menu.

PROGRAMMING OVERVIEW

The controller must be programmed before being placed into service.

IMPORTANT

During programming, the controller is live at all times. For example, the contacts may open and close when adjusting the setpoint.

The Programming process uses a hierarchical menu structure that is easy to use. You press the t and u arrow buttons to move forward and backward through the menus.

NOTES:

1. The T775U controller interface is intuitive. You may find that you do not need the following procedure instructions to program the controller. You may want to use this procedure simply as a reference to locate the particular option or parameter of interest.
2. The menu can display only those relays that are defined in Setup (see "1.3.2. NBR OF RELAYS" on page 22). For example, if you configure only one relay, then only one relay displays on the appropriate menu.
3. If you press the **HOME** button or there is no keypad activity for four minutes, you exit Program mode and return to the home screen.
4. If you press the **MENU** button, you exit Program mode and return to the menu.

Setpoint and Differential

The following describes the relationship between setpoint and differential for heating and cooling. These settings are programmed for each output relay.

In heating mode, reverse acting mode, and humidify mode, the differential falls below the setpoint. The relay de-energizes when the temperature rises to the setpoint. As the temperature drops to the setpoint minus the differential, the relay energizes.

In cooling mode, direct acting mode, and dehumidify mode, the differential falls above the setpoint. The relay de-energizes when the temperature falls to the setpoint. As the temperature rises to the setpoint plus the differential, the relay energizes.

Setpoint High Limit

You can set an irreversible setpoint high limit maximum value for any single displayed setpoint value.

Adjust the setpoint (at any output) to the desired maximum setpoint. Then, simultaneously press the **HOME**, t, and u buttons and continue to press all three buttons for five seconds to set the setpoint high limit maximum to this value.

NOTE: You must press all three buttons at exactly the same time for this action to occur.

IMPORTANT

1. This action sets the maximum setpoint value of **all** outputs to the setpoint high limit maximum.
2. Setting the high limit setpoint maximum is **irreversible**. If you perform the action inadvertently and this setpoint adversely affects the control of your system, you must replace the controller.

Programming the T775U Controller

To program the controller, perform the setup configuration (see “1. Setup”) and then select one of the following procedures depending on whether the Reset function is to be used:

- Program the Outputs for No Reset — see “2. Programming Outputs (MOD and Relay) with No Reset” on page 26.
- Program the Outputs for Reset — see “3. Programming Outputs (MOD and Relay) with Reset” on page 29.

When programming is complete, you may continue with “4. Scheduling” on page 34.

1. SETUP

Setup provides the ability to change the factory default settings for the temperature sensors and outputs, to enable/disable reset control, and to enable/disable scheduling.

NOTE:

1. The T775U controller interface is intuitive. You may find that you do not need the following setup instructions for the sensors and outputs. You may want to use this procedure simply as a reference to locate the particular option or parameter of interest.
2. If you press the **HOME** button or there is no keypad activity for four minutes, you exit Setup mode and return to the home screen.
3. If you press the **MENU** button, you exit Setup mode and return to the menu.

Once in Setup mode, you use the —

- **Left arrow button** (←) to scroll backward through the Setup menus
- **Right arrow button** (→) to select the highlighted menu item and display its content
- **Up and Down arrow buttons** (↑ and ↓) to scroll up and down through a list of items or to increase or decrease the value of a displayed setup parameter

Setup Procedure

The Setup process uses a hierarchical menu structure that is easy to use. You press the t and u arrow buttons to move forward and backward through the menus.

NOTE: The menus can display only those relays that are defined in Setup (see “1.3.2. NBR OF RELAYS” on page 22). For example, if you configure only two relays, then only two relays display on the appropriate menus.

To change the controller’s sensors and output setup parameters, perform the following procedures in the order listed:

1. Enter Setup mode — see “1.1. Entering Setup Mode”
2. Setup Sensors — see “1.2. Setting up the Sensors”
3. Setup Outputs — see “1.3. Setting up the Outputs” on page 18
4. Exit Setup Mode — see “1.4. Exiting Setup” on page 26

1.1. Entering Setup Mode

To enter Setup mode, press and hold the MENU button for five seconds to display the Setup menu. See Fig. 24 on page 13.

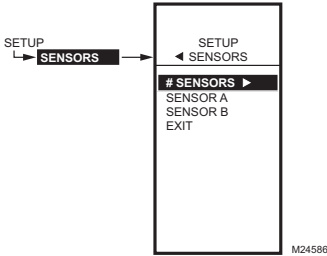

Fig. 25. Setup - Sensors Menu.

1.2. Setting up the Sensors

1. From the Setup menu, use the p and q buttons to highlight SENSORS.
2. Press the u button to display the Sensors menu.

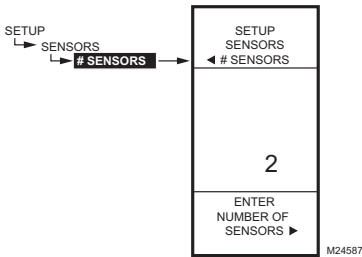

Fig. 26. Setup - Sensors - Number of Sensors.

1.2.1. Number of SENSORS

The value entered here determines the number of sensors displayed on the home screen.

NOTE: For applications that do not use Reset, only one sensor (Sensor A) is available for use.

1. From the Sensors menu, highlight # SENSORS then press the u button to display the number of sensors.
2. Use the p and q buttons to enter the number of sensors (1 or 2).
Default: 2
3. Press the u button to accept the value and display the SENSOR A selection.

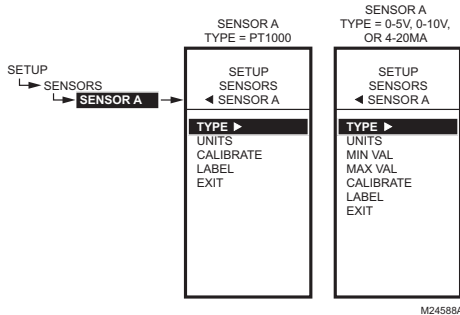

Fig. 27. Setup - Sensors - Sensor A Menu.

1.2.2. SENSOR A

If you are implementing two-sensor reset control, Sensor A must always be the controlled temperature and Sensor B must always be the controlling temperature. For example, in a reset control based on outside temperature, Sensor A must be the inside sensor and Sensor B must be the outside sensor.

1. From the Sensors menu, highlight SENSOR A.
2. Press the u button to display the Sensor A selections.

The menu selections change depending on whether the sensor type is 1097□ PTC (temperature) or 0-10V / 4-20MA.

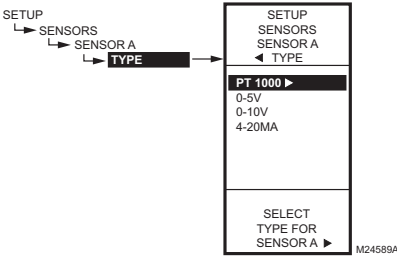

Fig. 28. Setup - Sensors - Sensor A - Type.

1.2.2.1. TYPE (Sensor A only)

1. From the Sensor A selections, use the p and q buttons to highlight TYPE.
2. Press the u button to display the type values.
3. Use the p and q buttons to highlight the desired value PT1000 (1097 PTC), 0-5V, 0-10V, or 4-20MA.

Default: PT1000

NOTE: The default label PT1000 refers to a 1097 PTC temperature sensor.

4. Press the u button to accept the units and return to the Sensor A selections.
5. For PT1000 (1097 PTC) temperature sensors, go to "1.2.2.2.1. UNITS (Sensor A or B; PT1000 [1097W PTC])". For 0-5V, 0-10V, and 4-20MA sensors, go to "1.2.2.2.2. UNITS (Sensor A only; 0-5V, 0-10V, or 4-20mA)".

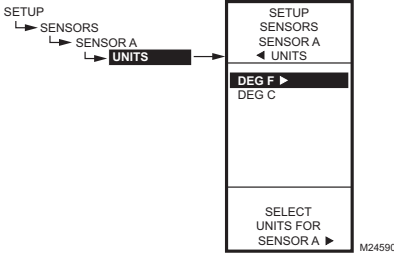

Fig. 29. Setup - Sensors - Sensor A - Units.

1.2.2.2.1. UNITS (Sensor A or B; PT1000 [1097 PTC])

If Sensor A is configured for °F or °C units, then the units selection does not appear for Sensor B, since Sensor B uses the units specified for Sensor A.

1. From the Sensor A selections, use the p and q buttons to highlight UNITS.
2. Press the u button to display the temperature units.
3. Use the p and q buttons to highlight F or C. Default: F (Fahrenheit)
4. Press the u button to accept the units and return to the Sensor A selections.

Continue with "1.2.2.3. CALIBRATE (Sensor A or B)".

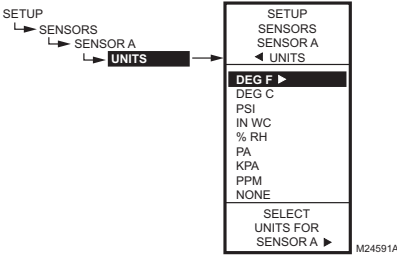

Fig. 30. Setup - Sensors - Sensor A - Units.

1.2.2.2.2. UNITS (Sensor A only; 0-5V, 0-10V, or 4-20mA)

1. From the Sensor A selections, use the p and q buttons to highlight UNITS.
2. Press the u button to display the units list.
3. Use the p and q buttons to scroll through the list and highlight the desired unit of measure. You may need to scroll up or down to view all units. Default: F (Fahrenheit)
4. Press the u button to accept the units and return to the Sensor A selections.

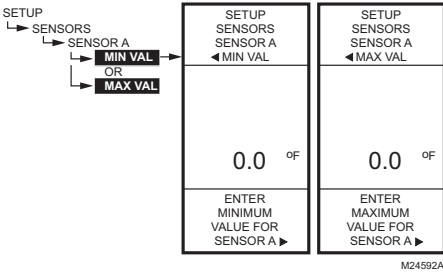

Fig. 31. Setup - Sensors - Sensor A - 0-5V, 0-10V, OR 4-20MA - MIN and MAX Value (showing °F).

1.2.2.3. MIN or MAX VALUE (Sensor A only; 0-5V, 0-10V or 4-20mA)

The minimum and maximum values display only for Sensor A when its type is 0-5V, 0-10V or 4-20MA.

1. From the Sensor A selections, use the p and q buttons to highlight MIN VAL or MAX VAL.
2. Press the u button to display the units.
3. Use the p and q buttons to increase/decrease the desired value.

Sensor Ranges:

- °F-60.0 to 270.0
- °C-51.0 to 132.0
- PSI-500 to 500
- IN WC-30.0 to 30.0
- %0.0 to 100.0
- PA-3000 to 3000
- KPA-3000 to 3000
- PPM 0 to 9990
- NONE -9999 to 9999

4. Press the u button to accept the units and return to the Sensor A selections.

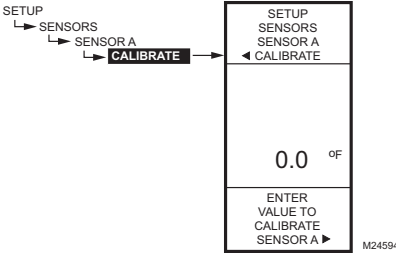

Fig. 32. Setup - Sensors - Sensor A - Calibrate.

1.2.2.3. CALIBRATE (Sensor A or B)

Ensure that the wire size calibration value is within the limits for the sensor.

- For temperature sensors, see “Temperature Sensor Calibration” on page 11.
- For other sensors, see “Humidity, Pressure, and Universal Sensor Calibration” on page 11.

1. From the Sensor A selections, use the p and q buttons to highlight CALIBRATE.
2. Press the u button to display the calibration value.
3. Use the p and q buttons to increase/decrease the desired calibration value.

Default: 0.0

Sensor Range Temperature: +/-10°F (+/-6°C)

Other Sensor Range: +/-10% of the Min to Max values specified previously. See Table 3 on page 11 for examples.

4. Press the u button to accept the value and return to the Sensor A selections.

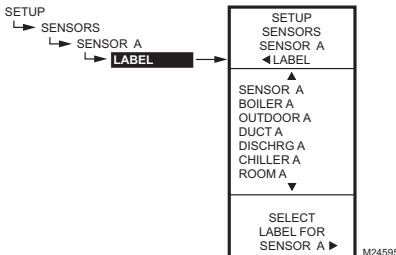

Fig. 33. Setup - Sensors - Sensor A - Label.

1.2.2.4. LABEL (Sensor A or B input)

For a sensor already labeled, the display positions to and highlights that label.

1. From the Sensor A selections, use the p and q buttons to highlight LABEL.
2. Press the u button to display the label list.
3. Use the p and q buttons to scroll through the list and highlight the desired label. You may need to scroll up or down to view all possible labels.
4. Use the u button to accept the highlighted label and exit the list.

NOTE: The label names in list order are: Sensor, Boiler, Outdoor, Duct, Dischrg, Chiller, Room, Supply, Return, and Animals.

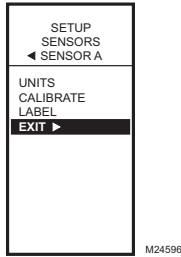

Fig. 34. Setup - Sensors - Sensor A - Exit.

1.2.2.5. Exit Sensor A Setup

Press the **t** button to exit Sensor A selections and return to the Sensors menu.
or
Use the **p** and **q** buttons to highlight EXIT and press the **u** button.

Continue with "1.2.3. SENSOR B (Temperature only)"

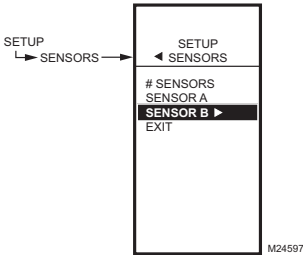

Fig. 35. Setup - Sensors - Sensor B Menu.

1.2.3. SENSOR B (Temperature only)

For two-sensor reset control, Sensor B must always be the controlling temperature. For example, in a reset control based on outside temperature, Sensor B must be the outside sensor.

NOTE: Sensor B is available only for reset on the T775U2006, but can be controlled just like Sensor A on the T775U2016.

1. From the Sensors menu, use the **q** button to highlight SENSOR B.
2. Press the **u** button to display the Sensor B menu.
3. Repeat the selections described in "1.2.2. SENSOR A" through "1.2.2.4. LABEL (Sensor A or B input)" beginning on page 15, but perform only those steps applicable to Sensor B.
4. Press the **t** button to exit SENSOR B and return to the Sensors menu.
or
Use the **p** and **q** buttons to highlight EXIT and press the **u** button.
5. Press the **t** button to exit the Sensors menu and return to the Setup menu.

Continue with "1.3. Setting up the Outputs".

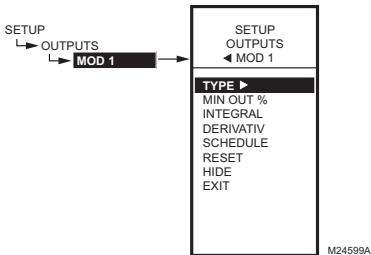

Fig. 36. Setup - Outputs Menu.

1.3. Setting up the Outputs

1. From the Setup menu, use the **p** and **q** buttons to highlight OUTPUTS.
2. Press the **u** button to display the Outputs menu.

NOTE: The menu (e.g. the Outputs menu shown here) can display only those relays that are defined in Setup (see page 22). For example, if you configure only two relays, then only two relays display on the appropriate menus.

The following procedures set up each modulating output and relay output.

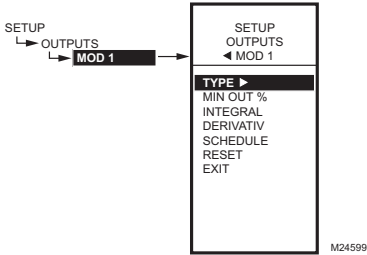

Fig. 37. Setup - Outputs - Modulating Output Menu.

1.3.1. Setting up the Modulating Outputs

1. From the Output menu, use the p and q buttons to highlight the desired modulating output (MOD 1 or MOD 2).
2. Press the u button to display the selected MOD menu.

Use the remaining procedures, beginning with “1.3.1.1. TYPE (of output signal)”, to set up each modulating output. If you have two modulating outputs, repeat these procedures for each modulating output.

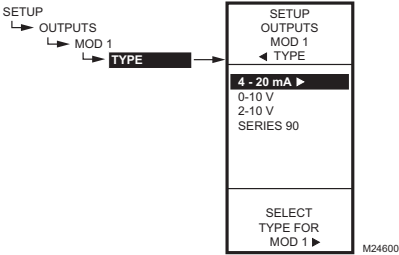

Fig. 38. Setup - Outputs - Mod Out - Type.

1.3.1.1. TYPE (of output signal)

1. From the Mod menu, use the p and q buttons to highlight TYPE.
2. Press the u button to display the Type selections.
3. Use the p and q buttons to highlight the desired output type.
Default: 4-20 mA
4. Press the u button to accept the selected type and return to the Mod menu.

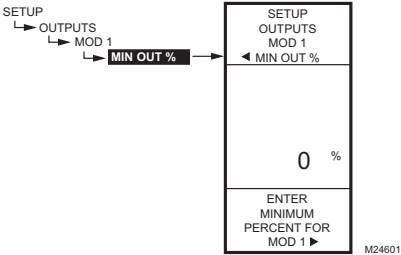

Fig. 39. Setup - Outputs - Mod Out - Minimum Output Percentage.

1.3.1.2. MIN OUT %

The minimum output % prevents the output from dropping below the value entered. This value can be useful to maintain minimum damper position.

Using the time clock or digital input to disable the output forces the output to 0%.

1. From the Mod menu, use the p and q buttons to highlight MIN OUT %.
2. Press the u button to display the Min Out %.
3. Use the p and q buttons to increase/decrease the desired value from 0% to 100% in 1% increments.
Default: 0%
Range: 0 to 100%
4. Press the u button to accept the percentage and return to the Mod menu.

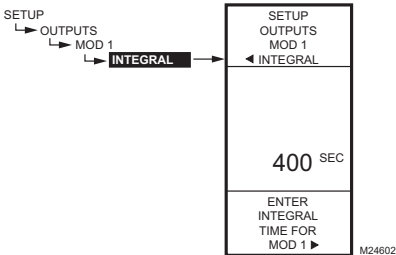

Fig. 40. Setup - Outputs - Mod Out - Integral.

1.3.1.3. INTEGRAL

1. From the Mod menu, use the p and q buttons to highlight INTEGRAL.
2. Press the u button to display the Integral seconds.
3. Use the p and q buttons to increase/decrease the value from 0 to 3,600 in 10 second increments.
Default: 400 seconds
Range: 0 to 3,600 seconds
4. Press the u button to accept the seconds and return to the Mod menu.

See the Notes on page 20 for Integral timing information.

NOTES: (Integral Timing)

1. The Integral time is factory set for 400 seconds. This is a good middle range and should satisfy many applications. The integral time can be increased for applications where sensed response is slow, and can be decreased for applications where sensed response is fast (e.g. discharge air control).
2. As a starting point, an optimal integral time for discharge air typically ranges from 12 to 200 seconds. An optimal integral time for room control typically ranges from 60 to 2,500 seconds. The purpose of integral action is to reduce or eliminate

the offset from setpoint during steady state control that is often seen in proportional only control.

3. Keep in mind that control is most sensitive to throttling range. Adjust the throttling range first before any adjustment to integral time. Adjust throttling range to be as wide as possible to start since this will provide the most stable control. Remember that the integral will eliminate the steady state error so you do not need to have a small throttling range to have accurate control. (Integral action allows for controlling to a setpoint even with a wide throttling range).

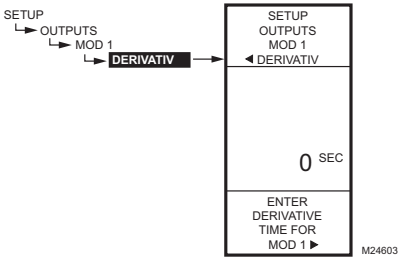

Fig. 41. Setup - Outputs - Mod Out - Derivative.

1.3.1.4. DERIVATIVE

The Derivative default value is factory set to zero (no derivative control). It is strongly recommended that the derivative remain at zero (0) unless you have a very good reason to adjust it. Derivative control is not needed in the vast majority of HVAC applications.

1. From the Mod menu, use the p and q buttons to highlight DERIVATIV.
2. Press the u button to display the Derivative seconds.
3. Use the p and q buttons to increase/decrease the value.
Default: 0 (zero)
Range: 0 to 3,600 seconds
4. Press the u button to accept the seconds and return to the Mod menu.

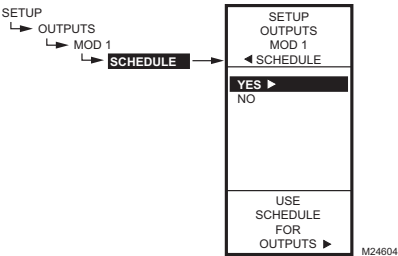

Fig. 42. Setup - Outputs - Mod Out - Schedule.

1.3.1.5. SCHEDULE

The Schedule option displays only if the USE SCHED parameter is set to Yes (see page 22).

1. From the Mod menu, use the p and q buttons to highlight SCHEDULE.
2. Use the p and q buttons to highlight YES or NO.
Default: YES
3. Press the u button to accept the selection and return to the Mod menu.

Each output can be set up to follow or ignore the built in scheduler. To disable the scheduler for all outputs, see "1.3.3.1. USE SCHED" on page 22.

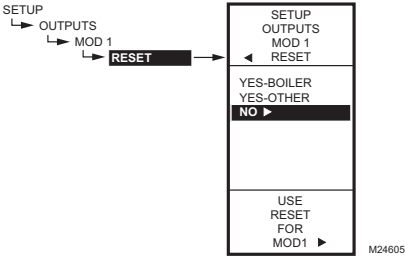

Fig. 43. Setup - Outputs - Mod Out - Reset.

1.3.1.6. RESET

This selection enables the controller's Reset function, and allows each output to be individually programmed for Reset or No Reset.

IMPORTANT

To use the Reset function of the controller, the first modulating output (MOD1) must be set for Reset here.

The RESET choice is offered for all outputs in setup mode, and you can set any or all of them for Reset=YES or Reset=NO. The default is Reset=NO.

For the remaining outputs, if Reset=YES, then these outputs use the reset curve programmed for the first output.

1. From the MOD menu, use the p and q buttons to highlight RESET.
2. Use the p and q buttons to highlight the desired value.
Default: NO
3. Press the u button to accept the selection and return to the Mod menu.

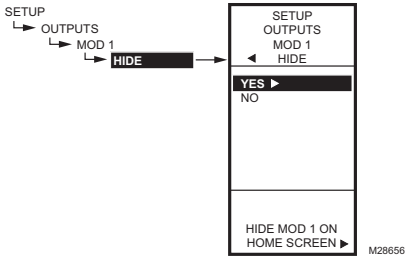

Fig. 44. Setup - Outputs - Mod 1/2- Hide.

1.3.1.7. Hide

The Hide option is used to prevent the MOD 1 and MOD 2 outputs from displaying on the Home screen.

1. From the Mod menu, use the p and q buttons to highlight HIDE.
2. Use the p and q buttons to highlight YES or NO.
Default: YES
3. Press the u button to accept the selection and return to the MOD menu.

NOTE: The MOD1 and MOD2 outputs are still active even when hidden from the Home screen.

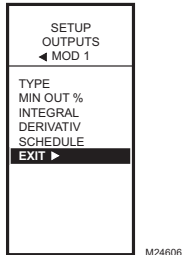

Fig. 45. Setup - Outputs - Mod Out - Exit.

1.3.1.7. Exit Modulating Outputs Setup

Press the t button (or highlight EXIT and press the u button) to exit the Mod menu and return to the Outputs menu.

To configure the second modulating output, go to "1.3.1. Setting up the Modulating Outputs" on page 19.

When you finish setting up the two modulating outputs, continue with "1.3.2. NBR OF RELAYS".

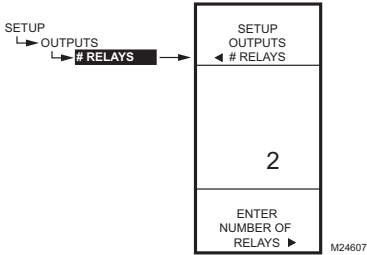

Fig. 46. Setup - Outputs - Number of Relays.

1.3.2. NBR OF RELAYS

1. From the Outputs menu, use the p and q buttons to highlight # RELAYS.
2. Press the u button to display the number of relays.
3. Use the p and q buttons to display the number from 1 to 2.
4. Press the u button to accept the value and display the Outputs menu.

The number of relay outputs entered here determines how many relays display on the home screen.

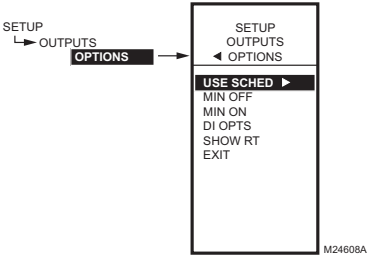

Fig. 47. Setup - Outputs - Options Menu.

1.3.3. OPTIONS

1. From the Outputs menu, use the p and q buttons to highlight OPTIONS.
2. Press the u button to display the Options menu.

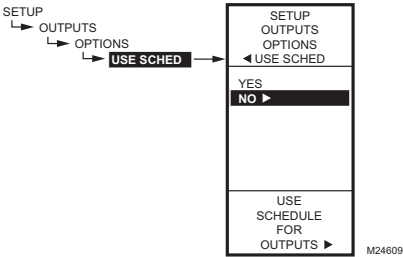

Fig. 48. Setup - Outputs - Options - Schedule.

1.3.3.1. USE SCHED

1. Press the u button to display the schedule selections.
2. Use the p and q buttons to highlight YES or NO. Default: NO
3. Press the u button to accept the value and display the MIN OFF option.

Selecting NO disables scheduling for **all** outputs.

Selecting YES enables scheduling for **all** outputs. When YES is selected, all individual outputs default to follow the schedule. However, each individual output can be removed from scheduling as desired.

With Scheduling enabled, when you return to Program mode, the new option for Scheduling displays. You can press the **HOME** button and then the **MENU** button to view the Schedule options in the menu.

See "1.3.1.5. SCHEDULE" on page 20.

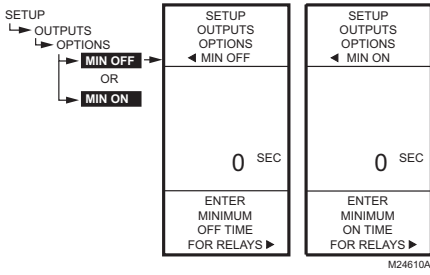

Fig. 49. Setup - Outputs - Options - Min Off/On Time.

1.3.3.2. MIN OFF or MIN ON

This is the minimum number of seconds of “off time” or “on time” for **all** relays.

1. Press the **u** button to display the Min Off/On value.
2. Use the **p** and **q** buttons to increase/decrease the desired number of seconds from 0 to 990 seconds in 10 second increments.
Default: 0 (zero)
Range: 0 to 990 seconds
3. Press the **u** button to accept the seconds and display the DI OPTIONS.

NOTES:

1. The minimum off time applies to **all** relay outputs.
2. When minimum off time is active, relays waiting to be energized display a flashing square underneath the relay number on the home screen.
3. If the minimum off time is not equal to zero (0), the minimum off time activates at power-up. To manually override, press the **t** button at any time.

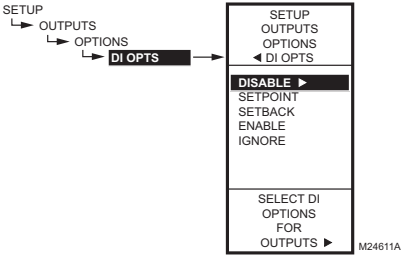

Fig. 50. Setup - Outputs - Options - DI Options.

1.3.3.3. DI OPTIONS (digital input options)

The DI Option you select applies to **all** outputs. This option overrides any Setpoint/Setback values entered in the Schedule.

1. Press the **u** button to display the DI Option selections.
2. Use the **p** and **q** buttons to highlight **DISABLE**, **SETBACK**, or **IGNORE**.
Default: **DISABLE**
3. Press the **u** button to accept the value and display the **SHOW RT** option.

When the digital input (DI) closes, all outputs follow the DI option value (Disable, Setback, or Ignore):

- **DISABLE** disables the outputs; relays return to de-energized state and Mod outputs return to 0% output.
- **SETBACK** forces the control to the setpoint temperature.
 - To program the Setback temperature with Reset, see Fig. 74 on page 32.
 - To program the Setback temperature without Reset, see Fig. 61 on page 27.
- **ENABLE** energizes all relays to 100%. Use this option carefully.
- **IGNORE** causes the digital input to have no effect on the Relay or Mod outputs.

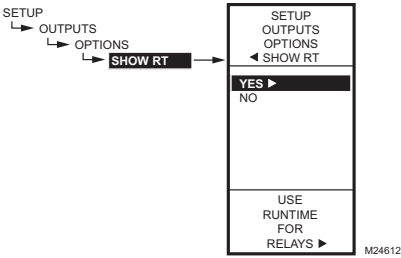

Fig. 51. Setup - Outputs - Options - Show Runtime.

1.3.3.4. SHOW RT (show run time hours)

1. Press the **u** button to display the Show RT values.
2. Use the **p** and **q** buttons to select **YES** or **NO**.
Default: **YES**
3. Press the **u** button to accept the value and return to the Options menu.

Selecting **YES** shows the RT (run time) hours for **each** relay on the home screen displays.

NOTE: Run times can be reset to zero for each individual relay. You must do this for each relay that you want to reset to zero. See “1.3.4.3. RESET RT (run time)” on page 26.

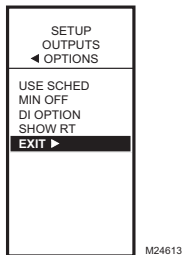

Fig. 52. Setup - Outputs - Options - Exit.

1.3.3.5. Exit Options Setup

Press the **t** button to exit the Options set up and return to the Outputs menu.

or
Use the **p** and **q** buttons to highlight **EXIT** and press the **u** button.

Continue with “1.3.4. Setting up the Relays”.

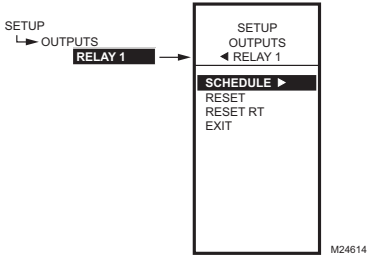

Fig. 53. Setup - Outputs - Relay Menu.

1.3.4. Setting up the Relays

1. From the Outputs menu, use the p and q buttons to highlight the desired relay (1 or 2).
2. Press the u button to display the selected Relay menu.

Continue with the remainder of this section to setup the relay outputs.

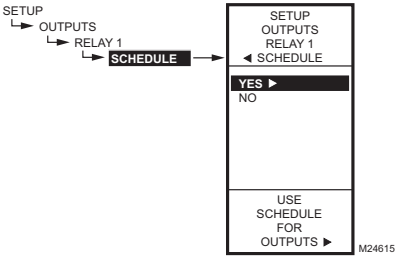

Fig. 54. Setup - Outputs - Relay - Schedule.

1.3.4.1. SCHEDULE

This selection displays only if “Use Sched = YES” is selected during the Output Options setup (see page 22). When selected, individual outputs default to follow the schedule.

1. Press the u button to display the Schedule values.
2. Use the p and q buttons to select YES or NO.
Default: YES
3. Press the u button to accept the value and return to the Relay menu.

An individual output can be selected to be controlled or not controlled by the schedule.

If NO is selected, the Setback selection does not appear in the Program menu for this output.

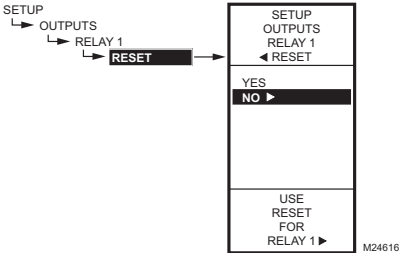

Fig. 55. Setup - Outputs - Relay - Reset.

1.3.4.2. RESET

IMPORTANT

For relays to use the Reset function of the controller, both modulating outputs (MOD 1 and MOD 2) must be set for Reset.

Relays that have Reset set to YES use the reset curve configured for MOD 1.

1. Press the u button to display the Reset values.
2. Use the p and q buttons to select YES or NO.
Default: NO
3. Press the u button to accept the value and return to the Relay menu.

- If you select YES, then **all** other outputs display this Setup option and will use the reset curve programmed for the first output.
- If you select NO, then No Reset is configured for that output and all other subsequent outputs.

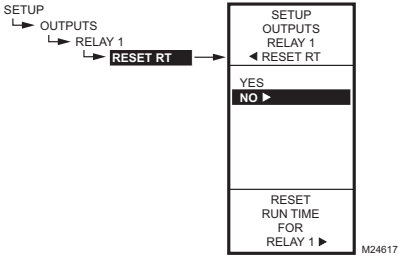

Fig. 56. Setup - Outputs - Relay - Reset Runtime.

1.3.4.3. RESET RT (run time)

This selection displays only if “Show RT = YES” is selected during Output Options setup (see page 24).

1. Press the u button to display the Reset RT values.
2. Use the p and q buttons to select YES or NO.
Default: NO
3. Press the u button to accept the value and return to the Relay menu.

Selecting YES immediately resets the output run time hours to zero for this output. When you subsequently return to this screen, the RESET RT defaults to NO.

NOTE: Run times can be reset to zero for each individual relay. You must do this for each relay that you want to reset to zero.

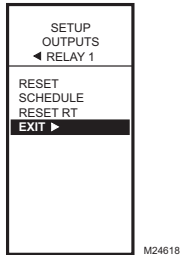

Fig. 57. Setup - Outputs - Relay - Exit.

1.3.4.4. EXIT Relay Setup

Press the t button to exit the selected relay set up and return to the Outputs menu.

To setup the next relay output go to “1.3.4. Setting up the Relays” on page 25.

When you finish setting up the relay outputs, continue with “1.4. Exiting Setup”.

1.4. Exiting Setup

Press the HOME button to exit Setup mode and return to the home screen display.

or
Use the p and q buttons to highlight EXIT from the menu and press the u button.

This completes the Setup procedure.

2. PROGRAMMING OUTPUTS (MOD AND RELAY) WITH NO RESET

The T775U can be programmed for Reset or No Reset. From the factory, the T775U is programmed for No Reset. This section describes the steps necessary to program the controller for No Reset.

NOTE: For applications where Reset is not used, only one sensor (Sensor A) is available for use.

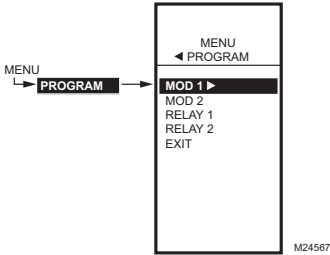

Fig. 58. Program Menu.

2.1. Entering Program Mode

Press the MENU button, then select PROGRAM and press the u button to view the Program menu.

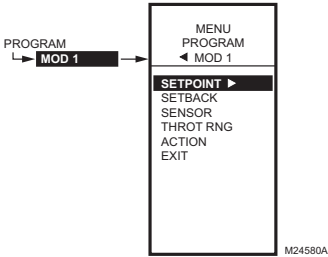

Fig. 59. Program Menu - No Reset.

2.1.1. Program Menu for Outputs with No Reset

From the Program menu, select MOD 1, MOD 2, RELAY 1, or RELAY 2 to view the parameters. This section illustrates the screens for selecting MOD 1, but other than as noted below, the programming is the same for each output.

NOTE: For Relays, DIFFRNTL replaces THROT RNG.

NOTE: The Setback parameter displays only if scheduling is enabled (see Fig. 48 on page 22) or the DI Option is set to Setback. (see Fig. 50 on page 24).

Continue with "2.1.2. SETPOINT".

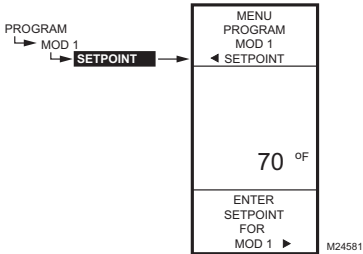

Fig. 60. Program - Setpoint.

2.1.2. SETPOINT

1. From the menu, use the p and q buttons to highlight SETPOINT.
2. Press the u button to display the setpoint value.
3. Use the p and q buttons to increase/decrease the desired setpoint temperature.
Default: 70°F (21°C)
Range: -40°F to 248°F (-40°C to 120°C)
4. Press the u button to accept the setpoint temperature and display the next option.

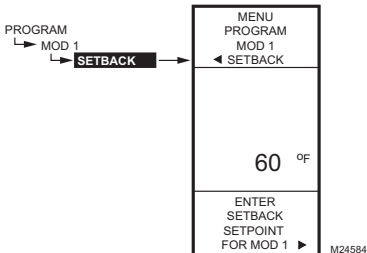

Fig. 61. Program - Setback.

2.1.3. SETBACK

The Setback temperature option displays only if scheduling is enabled (see Fig. 48 on page 22) or the DI Option is set to Setback. (see Fig. 50 on page 24).

This is the desired setpoint temperature that you want to use during setback mode for this output. For example, if your setpoint is 70°F and you want the temperature to drop 10°F during setback mode, enter 60°F as the setpoint for this output.

1. From the menu, use the p and q buttons to highlight SETBACK.
2. Use the p and q buttons to increase/decrease the desired setpoint temperature.

Default: 60°F (16°C)

Range: -40°F to 248°F (-40°C to 120°C)

- Press the u button to accept the value and display the menu.

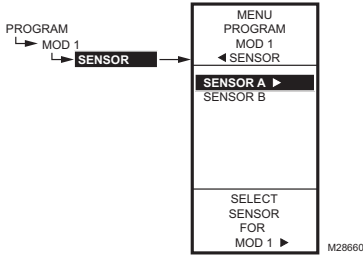

Fig. 62. Program - Sensor.

2.1.3. SENSOR

This sub-menu choice is only available on the T775U2016 model.

- From the menu, use the p and q buttons to highlight SENSOR A or SENSOR B.
- Press the u button to accept the sensor selection and display the next option.

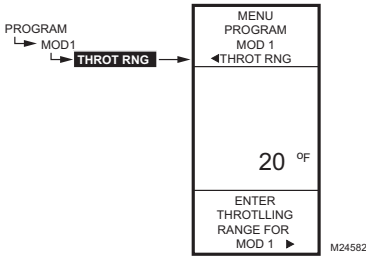

Fig. 63. Program - Throttling Range or Differential.

2.1.5. THROTTLING RANGE or DIFFERENTIAL

Throttling Range displays for Modulating outputs. Differential is used for the Relay outputs.

- From the menu, use the p and q buttons to highlight THROT RNG or DIFFERNTL.
- Press the u button to display the throttling range value.
- Use the p and q buttons to increase/decrease the desired value.
Default: 20°F (-6.6°C)
Range: 1°F to 150°F (1°C to 66°C)
- Press the u button to accept the value and display the next option.

The Throttling Range brackets the setpoint setting, e.g., if the setpoint is 72°F and the throttling range is 10°F, then the effective throttling temperature range is 67°F to 77°F.

In heating mode, the Differential is below the setpoint. The relay de-energizes when the temperature rises to the setpoint. As the temperature drops to the setpoint minus the Differential, the relay energizes.

In cooling mode, the Differential is above the setpoint. The relay de-energizes when the temperature falls to the setpoint. As the temperature rises to the setpoint plus the Differential, the relay energizes.

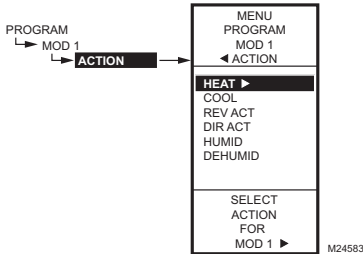

Fig. 64. Program - Action.

2.1.6. ACTION

- From the menu, use the p and q buttons to highlight ACTION.
Default: HEAT
- Press the u button to display the action selections.
- Use the p and q buttons to select the desired value.
- Press the u button to accept the highlighted selection and display the next option.

2.2. Program Next Output (Modulating Output or Relay)

For the next output, select the desired MOD or Relay from the Program menu (see Fig. 58 on page 27).

Go to "2.1.2. SETPOINT" on page 27 to continue programming.

When you finish programming the outputs, continue with "1.3. Exit Programming without Reset".

1.3. Exit Programming without Reset

Press the **HOME** button to leave programming mode and return to the home screen.

This completes the programming procedure for controllers that do not use Reset.

3. PROGRAMMING OUTPUTS (MOD AND RELAY) WITH RESET

The T775U can be programmed for Reset or No Reset for each output. From the factory, the T775U is programmed for No Reset. This section describes the steps necessary to program the controller for Reset.

To use the Reset feature, the first output (MOD 1) must be set to Reset=YES in Setup mode (see "3.1. Setting Up the Controller for Reset").

NOTE: Even if the MOD outputs are not used, both MOD 1 and MOD 2 must be set to Reset in order to configure Reset for the relay(s).

The reset curve established when programming the first output (MOD 1) is then used for all subsequent outputs that are configured for Reset, and each of those outputs will be offset from this curve.

For all outputs that will follow a reset curve, be sure to configure for Reset=YES in the setup mode. Choose Reset YES or NO for all other outputs you wish to reset, then press the **HOME** button to record your selection.

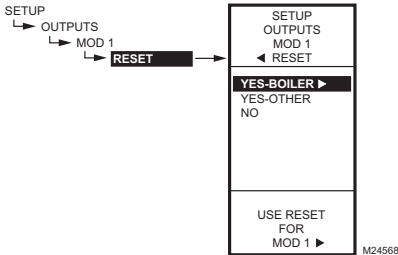

Fig. 65. Reset Setup.

NOTE: The first output, Mod 1, must be set for Reset to enable the controller's Reset function.

3.1. Setting Up the Controller for Reset

1. Press and hold the MENU button for five seconds to enter Setup mode.
2. Then choose:
 OUTPUTS \leftarrow
 MOD 1 \leftarrow
 RESET \leftarrow
 then select YES-BOILER or YES-OTHER (Fig. 65).

You can now press the **HOME** button to exit Setup mode and continue with "Determining and Setting the Reset Values".

Determining and Setting the Reset Values

NOTE: When using the Reset feature, Sensor A must be sensing the controlled temperature (e.g. Boiler), Sensor B must be sensing the resetting temperature (e.g. outdoor temp).

To program an output for Reset, refer to the values as shown in the examples below. Choose your own appropriate values for Sensor A maximum and minimum and Sensor B maximum and minimum.

Reset Example: (see Fig. 66)

- Sensor A is the boiler sensor and Sensor B is the outdoor sensor.

- Maximum boiler temperature desired is 210°F when the outdoor temperature is 20°F.
- Minimum boiler temperature desired is 160°F when the outdoor temperature is 70°F.
- With the above settings example, when the outdoor temperature is 50°F, the effective setpoint is 180°F.

Setback (optional) Example: (see Fig. 66)

- Setback of -10°F is used to drop the temperature at night by 10°F.
- With the above settings example, when the outdoor temperature is 50°F, the effective setback setpoint is 170°F (180°F setpoint minus the 10°F setback).

NOTE: A single reset curve is programmed for the MOD 1 output and is used by all outputs setup with RESET=YES.

CAUTION

If using the time clock or DI to go to setback, the T775P will shift the reset curve up or down and cause the controlled setpoint to exceed either the entered reset max. temp or min. temp (dropping below reset minimum is most common, since setback is normally below setpoint). If this is not desired, either do not use setback, or adjust the min. and max. values entered so that critical setpoints are not exceeded in the setback mode.

When Reset is programmed, the home screen displays the calculated Heat/Cool setpoint(s) for the Mod and Relay outputs based on the reset curve. See Fig. 22 on page 12.

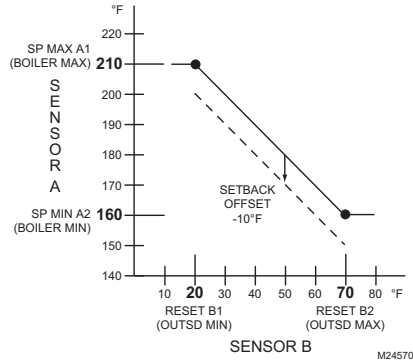

Fig. 66. Reset Curve for MOD 1 with Setback Offset.

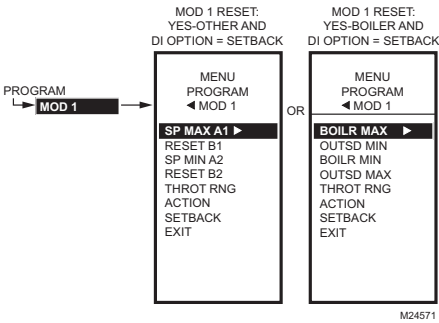

Fig. 67. Setpoint Values for Reset and Setback.

3.2. Program Menus for Outputs with Reset

Press the MENU button, select PROGRAM, then highlight MOD 1 and press the u button to view the parameters.

The Reset curve settings (Fig. 68 through Fig. 71) are programmed for the first output (MOD 1) and these settings apply to all outputs that are configured for Reset. See Fig. 66 for the reset curve values used in the following section.

NOTE: The Setback parameter displays only if scheduling is enabled (see Fig. 48 on page 22) or the DI Option is set to Setback (see Fig. 50 on page 24).

3.2.1. SP MAX A1 or BOILER MAX (Setpoint maximum for Sensor A)

1. From the menu, use the p and q buttons to highlight BOILER MAX or SP MAX A1.
2. Press the u button to display the maximum setpoint value.
3. Use the p and q buttons to increase/decrease the desired maximum setpoint temperature.
Default: 180°F (82°C)
Range: -40°F to 248°F (-40°C to 120°C)
4. Press the u button to accept the setpoint temperature and display the next option.

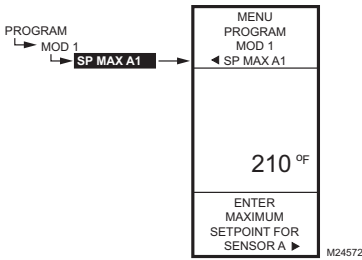
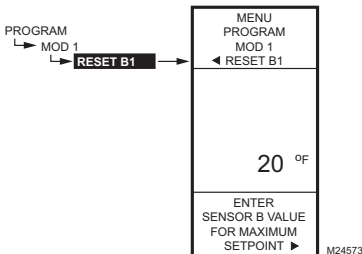

Fig. 68. Program - Sensor A Max. Setpoint.

Fig. 69. Program - Sensor B Max. Setpoint.



3.2.2. RESET B1 or OUTSD MIN

(Sensor B value when at SP MAX A1 Setpoint)

1. From the menu, use the p and q buttons to highlight RESET B1 or OUTSD MIN.
2. Press the u button to display the setpoint value.

3. Use the p and q buttons to increase/decrease the desired setpoint temperature.
Default: 10°F (-12°C)
Range: -40°F to 248°F (-40°C to 120°C)
4. Press the u button to accept the value and display the next option.

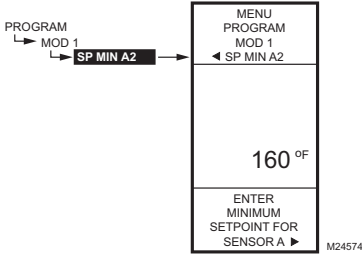

Fig. 70. Program - Sensor A Min. Setpoint.

3.2.3. SP MIN A2 or BOILER MIN

(Setpoint minimum for Sensor A)

1. From the menu, use the p and q buttons to highlight BOILER MIN or SP MIN A2.
2. Press the u button to display the setpoint value.
3. Use the p and q buttons to increase/decrease the desired minimum setpoint temperature.
Default: 140°F (60°C)
Range: -40°F to 248°F (-40°C to 120°C)
4. Press the u button to accept the setpoint temperature and display the next option.

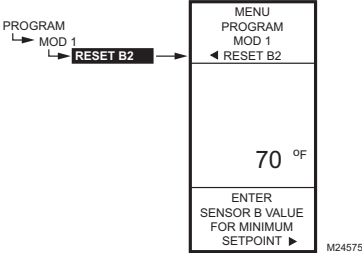

Fig. 71. Program - Sensor B Min. Setpoint.

3.2.4. RESET B2 or OUTSD MAX

(Sensor B value when at MIN A2 Setpoint)

1. From the menu, use the p and q buttons to highlight RESET B2.
2. Press the u button to display the setpoint value.
3. Use the p and q buttons to increase/decrease the desired setpoint temperature.
Default: 60°F (16°C)
Range: -40°F to 248°F (-40°C to 120°C)
4. Press the u button to accept the value and display the next option.

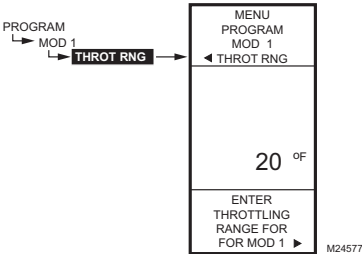

Fig. 72. Program - Throttling Range or Differential.

3.2.5. THROTTLING RANGE or DIFFERENTIAL

Throttling Range displays for Modulating outputs. Differential is used for the Relay outputs.

1. From the menu, use the p and q buttons to highlight THROT RNG or DIFFERNTL.
2. Press the u button to display the throttling range value.
3. Use the p and q buttons to increase/decrease the desired value.
Default: 20°F (-6.6°C)
Range: 1°F to 150°F (1°C to 66°C)
4. Press the u button to accept the value and display the next option.

The Throttling Range brackets the setpoint setting, e.g., if the setpoint is 72°F and the throttling range is 10°F, then the effective throttling temperature range is 67°F to 77°F.

In heating mode, the Differential is below the setpoint. The relay de-energizes when the temperature rises to the setpoint. As the temperature drops to the setpoint minus the Differential, the relay energizes.

In cooling mode, the Differential is above the setpoint. The relay de-energizes when the temperature falls to the setpoint. As the temperature rises to the setpoint plus the Differential, the relay energizes.

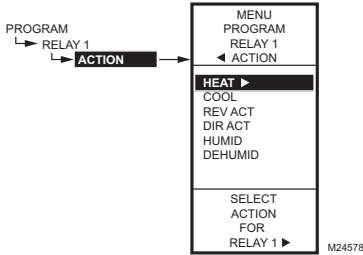

Fig. 73. Program - Action Selection.

3.2.6. ACTION

For the MOD 1 output (and for outputs with RESET=NO), the ACTION selection displays.

For all other outputs with RESET=YES, the ACTION selection does **not** display; continue with "3.2.7. SETBACK OFFSET (if configured)" on page 32.

1. From the menu, use the p and q buttons to highlight ACTION.
Default: HEAT
2. Press the u button to display the action selections.
3. Use the p and q buttons to select the desired value.
4. Press the u button to accept the highlighted selection and display the next option.

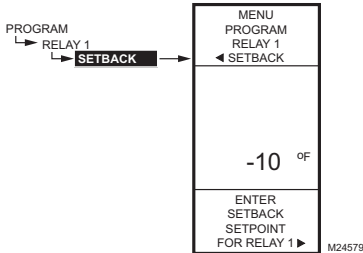

Fig. 74. Program - Setback (Offset).

3.2.7. SETBACK OFFSET (if configured)

The Setback temperature option displays only if scheduling is enabled (see Fig. 48 on page 22) or the DI Option is set to Setback. (see Fig. 50 on page 24).

This value is the number of degrees plus (+) or minus (-) that you want the temperature to be offset from the setpoint.

For example, If you want the temperature to be 10°F less than the setpoint during setback mode, enter -10°F. In normal operations for heating, the offset will be negative. For cooling, the offset will be a positive value.

1. From the menu, use the p and q buttons to highlight SETBACK.
2. Use the p and q buttons to increase/decrease the desired setpoint temperature.
Default: 0°F
Range: -150°F to 150°F (-101°C to 66°C)
3. Press the u button to accept the value and display the menu.

This completes the programming of the MOD 1 output.

To program the second Modulating output and the two relays, continue with "3.3. Second Modulating Output and Relays".

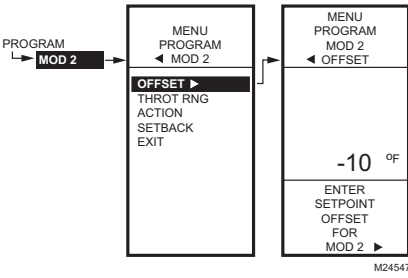

Fig. 75. Program - Setpoint Offset (MOD 2 only).

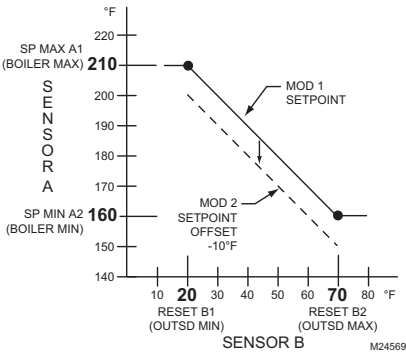

Fig. 76. Reset Curve with Offset for MOD 2.

3.3. Second Modulating Output and Relays

For the second Modulating Output and the two Relays (if they are configured for Reset), the Offset parameter displays on the Program menu as shown in Fig. 75.

3.3.1. SETPOINT OFFSET (MOD 2 only)

This value is the number of degrees plus (+) or minus (-) that you want the temperature to be offset from the MOD 1 setpoint. See Fig. 76. For example, If you want the MOD 2 setpoint to be 10°F less than the MOD 1 setpoint, enter -10°F.

1. From the menu, use the p and q buttons to highlight OFFSET.
2. Press the u button to display the value.
3. Use the p and q buttons to increase/decrease the desired temperature.
 OFFSET Default: 0°F
 OFFSET Range: -150°F to 150°F (-101°C to 66°C)
4. Press the u button to accept the value and display the next option.

3.3.2. Second Modulating Output and Relays Programming

To complete the programming of MOD 2 or a Relay, perform the procedures in “3.2.5. THROTTLING RANGE or DIFFERENTIAL” through “3.2.7. SETBACK OFFSET (if configured)” beginning on page 31.

3.4. Exit Programming with Reset

When you finish programming the Modulating outputs and the Relays, press the HOME button to leave programming mode and return to the home screen.

This completes the programming procedure for controllers that use Reset.

4. SCHEDULING

Scheduling provides the ability to set daily temperature settings for up to two events per day. Typically, these are the daytime (setpoint) and the nighttime (setback) settings.

IMPORTANT

To enable Scheduling, you must first enter Setup mode (press and hold the **MENU** button for 5 seconds), select **OUTPUTS**, select **OPTIONS**, select **USE SCHED**, and then select **YES**. (see “1.3.3.1. USE SCHED” on page 22).

IMPORTANT

To properly account for Daylight Saving time, be sure to set the Date **before** setting the Time. See “4.2.2. SET DATE” on page 35.

NOTE: The T775U controller interface is intuitive. You may find that you do not need the following scheduling instructions. You may want to use this procedure simply as a reference to locate the particular option or parameter of interest.

NOTE: Each output is independently configurable to follow the schedule or not. For modulating outputs, see “1.3.1.5. SCHEDULE” on page 20. For relay outputs, see “1.3.4.1. SCHEDULE” on page 25.

NOTES:

1. If you press the **HOME** button or there is no keypad activity for four minutes, you exit Scheduling mode and return to the home screen.
2. If you press the **MENU** button, you exit Scheduling mode and return to the menu.

To create or change a schedule, you use the —

- **Left arrow button** (t) to scroll backward through the Setup menus
- **Right arrow button** (u) to select the highlighted menu item and display its content
- **Up and Down arrow buttons** (p and q) to scroll up and down through a list of items or to increase or decrease the value of a displayed setup parameter

Creating a Schedule

To create a schedule, perform the following in the order listed:

1. Enable Scheduling in Setup mode - see “1.3.3.1. USE SCHED” on page 22
2. Enter Schedule mode — see “4.1. Entering Schedule Mode”
3. Set the Schedule Options — see “4.2. OPTIONS”
4. Set Individual Schedules — begin with “4.3. Setting Individual Schedules” on page 36
5. Exit Schedule Mode — see “4.4. Exiting Scheduling Mode” on page 37

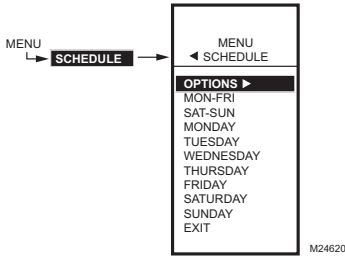

Fig. 77. Schedule - Menu.

4.1. Entering Schedule Mode

Press the **MENU** button, then select **SCHEDULE** and press the u button to view the Schedule menu.

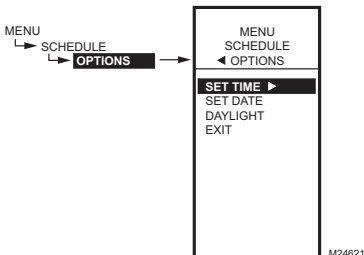

Fig. 78. Schedule - Options Menu.

4.2. OPTIONS

1. From the Schedule menu, use the p and q buttons to highlight **OPTIONS**.
2. Press the u button to display the Options menu.

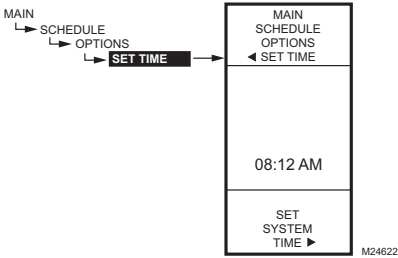

Fig. 79. Schedule - Options - System Time.

4.2.1. SET TIME

Setting the system time is required to enable the controller to follow daylight saving time.

IMPORTANT

Set the Date before setting the Time. See "4.2.2. SET DATE".

1. From the Options menu, use the p and q buttons to highlight SET TIME.
2. Press the u button to display the current system time setting.
3. Use the u button to cycle between the hour, minute, and AM/PM values.
4. Use the p and q buttons to increase/decrease the desired value for the hour, minute, and AM/PM.
5. Press the t button to accept the Time and return to the Options menu.

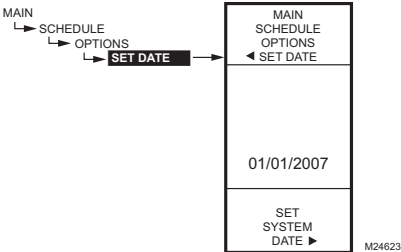

Fig. 80. Schedule - Options - System Date.

4.2.2. SET DATE

Setting the system date is required to enable the controller to follow daylight saving time.

IMPORTANT

To properly account for Daylight Saving time, be sure to set the Date before setting the Time.

1. From the Options menu, use the p and q buttons to highlight SET DATE.
2. Press the u button to display the current system date setting.
3. Use the u button to cycle between the month, day, and year values.
4. Use the p and q buttons to increase/decrease the desired value for the month, day, and year.
5. Press the t button to accept the Date and return to the Options menu.

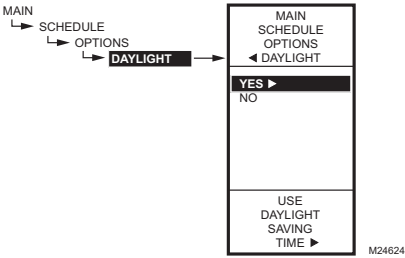

Fig. 81. Schedule - Options - Daylight Saving Time.

4.2.3. DAYLIGHT (daylight saving time)

1. From the Options menu, use the p and q buttons to highlight DAYLIGHT.
2. Press the u button to display the current system setting for daylight saving time.
3. Use the p and q buttons to select YES or NO.
Default: YES
4. Press the u button to accept the value and return to the Options menu.
5. From the Options menu, use the p and q buttons to highlight EXIT.
6. Press the u button to return to the Schedule menu.

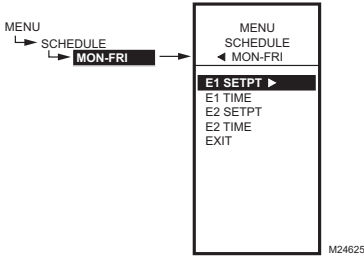

Fig. 82. Schedule Event Menu (Showing MON-FRI).

4.3. Setting Individual Schedules

As shown in the Schedule menu (Fig. 77 on page 34), schedules can be set for the following time periods:

- Monday through Friday
- Saturday and Sunday
- Individual days of the week

1. From the Schedule menu, use the p and q buttons to highlight the desired time period.
2. Press the u button to display the Schedule menu for the selected time period.

For each selected time period, the schedule event (E1 and E2) parameters are exactly the same as shown in Fig. 82.

SCHEDULING EXAMPLE

Setting the schedule is independent of the temperature settings for the relay outputs. Table 5 illustrates a weekly schedule for daytime (setpoint) and night time (setback) use and shows the factory default settings.

Table 5. Mon-Fri Schedule Defaults

DAY	EVENT	SETPT ACTION	TIME
Mon-Fri	Event 1 (E1)	Setpoint	6:00 AM ^a
Mon-Fri	Event 2 (E2)	Setback	6:00 PM ^b
Sat-Sun	Not used; remains in Setback from the Mon-Fri E2 settings		

^a Setpoint time span is 6:00 AM until 5:59 PM because setback starts at 6:00 PM.

^b Setback time span is 6:00PM until 5:59 AM because setpoint starts at 6:00 AM.

To set a schedule, continue with "4.3.1. E1 SETPT (setpoint for event 1)".

The following figures show the MON-FRI menu, but the menu selections are the same for any time period.

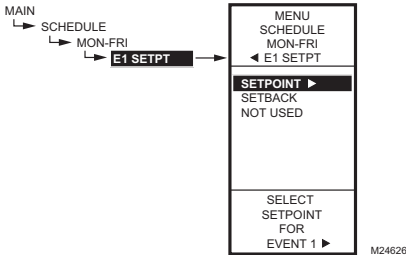

Fig. 83. Schedule - Event 1 Setpoint.

4.3.1. E1 SETPT (setpoint for event 1)

1. From the selected time period menu, use the p and q buttons to highlight E1 SETPT.
2. Press the u button to display the setpoint options.
3. Use the p and q buttons to highlight the desired option.
4. Press the u button to accept the value and return to the selected time period menu.

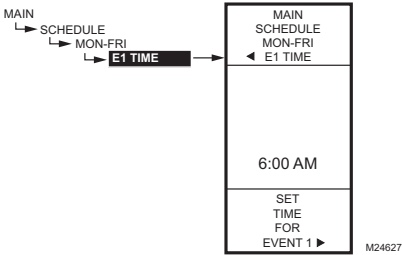

Fig. 84. Schedule - Event 1 Time.

4.3.2. E1 TIME (time for event 1)

1. From the selected time period menu, use the p and q buttons to highlight E1 TIME.
2. Press the u button to display the current time setting for event 1.
3. Use the u button to cycle between the hour, minute, and AM/PM values.
4. Use the p and q buttons to increase/decrease the desired value for the hour, minute, and AM/PM.
5. Press the t button to accept the time and return to the selected time period menu.

4.3.3. E2 SETPOINT (setpoint for event 2)

Creating the setpoint for event 2 is accomplished the same way as the first event. See “4.3.1. E1 SETPT (setpoint for event 1)” on page 36 above.

4.3.4. E2 TIME (time for event 2)

Creating the time for event 2 is accomplished the same way as the first event. See “4.3.2. E1 TIME (time for event 1)” above.

4.3.5. EXIT (exit from selected time period settings)

After entering the time for event 2, use the t button to exit the schedule time period and return to the Schedule menu to select a different time period.

When you finish scheduling the time periods, continue with “4.4. Exiting Scheduling Mode”.

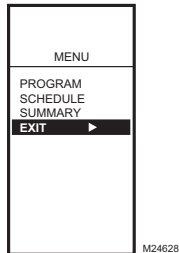

Fig. 85. Scheduling Mode Exit.

4.4. Exiting Scheduling Mode

Press the HOME button to exit the Schedule menu and return to the home screen display.

or

Press the t button to return to the menu, then use the p and q buttons to highlight EXIT from the menu and press the u button.

This completes the Scheduling procedure.

SUMMARY MENU

The Summary menu provides the ability to view the schedule (E1 and E2 times) for each relay for each day of the week.

NOTE: Scheduling must be enabled for the Summary menu to display. Enabling the schedule is determined in the Setup process for the Output Options (see page 22).

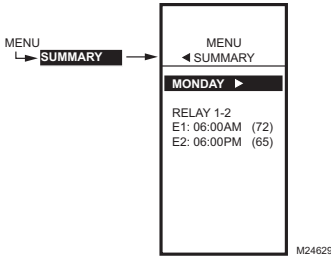

Fig. 86. Summary Example - Monday Settings.

For each relay, the Summary display indicates the time and temperature (in parenthesis) for each of the two scheduled events E1 and E2.

1. Press the MENU button to view the menu.
2. Use the p and q buttons to highlight SUMMARY.
3. Press the u button to display the Summary settings.
4. Use the u button to scroll forward through each day of the week (Monday, Tuesday, Wednesday, Thursday, Friday, Saturday, and Sunday).
5. While viewing a specific day, use the p and q buttons to cycle through the individual relay schedules for that day.

When finished, press the HOME button to return to the home display screen.

If programmed for Reset control, the Summary setpoints display as "RES" instead of a temperature value. For example, the display would show:

```

MONDAY
STAGES
E1: 06:00AM (RES) - indicating Reset
E2: 06:00PM (05) - setback/offset degrees
    
```

TROUBLESHOOTING

Power Loss

The date and time settings are retained for 24 hours after a power outage. After a power loss of more than 24 hours, the date and time settings may need to be reentered. All other settings are stored permanently.

Errors and Diagnostics

The controller provides an error message and diagnostic status as described below.

Error Message

There is a two-character error code that displays in response to controller software problems:

EE

EEPROM Failure— The values read back from the EEPROM are not the same as written into the EEPROM. This error cannot be field repaired. Replace the device.

Diagnostic Messages

There are two diagnostic messages that can display in response to sensor problems. The diagnostic codes that can flash on the display are:

--

Sensor Open or Shorted — Two dashes display when a sensor (typically temperature) is open or shorted. An open circuit is considered anything greater than 1570 ohms (greater than 300F), shorted anything less than 770 ohms (less than -73F). Which ever stages are operating with this sensor cease to control (meaning relays go to OFF and proportional outputs go to zero percent).

This message can also mean that the sensor is programmed, but not physically connected.

-60°F or 270°F (-51°C or 132°C) Blinking

Temperature Out of Range — The temperature display blinks when the sensed temperature range is outside of the display range, below -60°F (-51°C) or above 270°F (132°C). The displayed value remains at that displayed limit and control continues. Controller continues to function unless an open or shorted state is detected.

Blinking relay status

Relay Minimum Off Time is Active — On the home screen, each relay's indicator (c) blinks while the relay's minimum off time is active.

SPECIFICATIONS

Power: 24, 120, or 240 Vac; 50/60 Hz

A separate earth ground is required for any power source.

Power Consumption:

- 8 VA maximum at 60 Hz
- 10 VA maximum at 50 Hz

Operating & Storage Temperature Ambient Rating:

- -40°F to 125°F (-40°C to 52°C) @ 50 Hz
- -40°F to 140°F (-40°C to 60°C) @ 60 Hz

Relative Humidity: 5% to 95% non-condensing

Relay Contact Output Ratings (N.O. and N.C.):

- 1/2 hp; 9.8 AFL, 58.8 ALR @ 120 Vac
- 1/2 hp; 4.9 AFL, 29.4 ALR @ 240 Vac
- 125 VA pilot duty @ 120/240 Vac
- 10A @ 24 Vac (resistive)

Modulating Outputs:

- 0-10 Vdc; drive a minimum of 2,000 Ohms
- 2-10 Vdc; drive a minimum of 2,000 Ohms
- 4-20 mA; drive a maximum of 600 Ohms
- Electronic Series 90
- Floating

DoC

Emissions Compliance

EN 55022: 2006
 CISPR 22: 2006
 VCCI V-3/2006.04
 ICES-003, Issue 4: 2004
 FCC PART 15 SUBPART B Class B Limit

Immunity Compliance

EN 61000-6-1: 2001 covering
 EN 61000-4-2: 1995 + A1: 1998 + A2: 2001
 EN 61000-4-3: 2002
 EN 61000-4-4: 2004
 EN 61000-4-5: 1995 + A1: 2001
 EN 61000-4-6: 1996 + A1: 2001
 EN 61000-4-8: 1993 + A1: 2001
 EN 61000-4-11 2nd Ed.: 2004

Safety Compliance

UL 60730-1 for US and Canada

FCC Compliance Statement:

This equipment has been tested and found to comply with limits for a Class B digital device, pursuant to Part 15 of the FCC rules. These limits are designed to provide

reasonable protection against harmful interference in residential installations. This equipment generates, uses, and can radiate radio frequency energy, and if not installed and used in accordance with the instructions, may cause harmful interference to radio communications.

However, there is no guarantee that interference will not occur in a particular installation. If this equipment does cause interference to radio or television equipment reception, which can be determined by turning the equipment off and on, the user is encouraged to try to correct the interference by one or more of the following measures:

- Reorient or relocate the receiving antenna
- Move the equipment away from the receiver
- Plug the equipment into an outlet on a circuit different from that to which the receiver is connected
- Consult the dealer or an experienced radio/television technician for additional suggestions

You are cautioned that any change or modifications to the equipment not expressly approved by the party responsible for compliance could void Your authority to operate such equipment.

This device complies with Part 15 of the FCC Rules. Operation is subjected to the following two conditions 1) this device may not cause harmful interference and 2) this device must accept any interference received, including interference that may cause undesired operation.

Automation and Control Solutions

Honeywell International Inc.

1985 Douglas Drive North

Golden Valley, MN 55422

customer.honeywell.com

© U.S. Registered Trademark
© 2012 Honeywell International Inc.
62-0255—09 M.S. Rev. 05-12
Printed in United States

Honeywell