

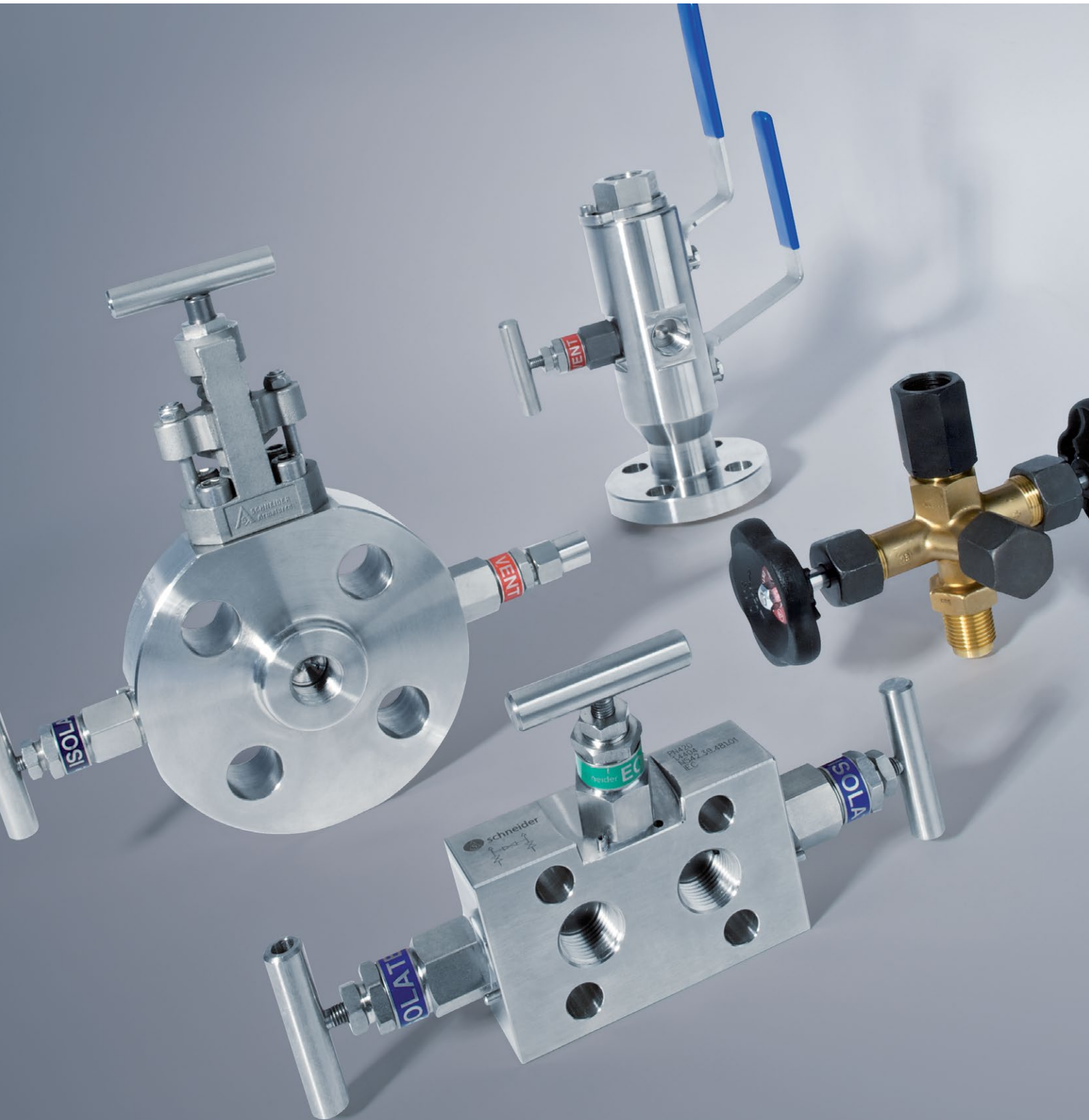

Instrumentation Products

Product Overview



AS-Schneider – At a glance

The family run company AS-Schneider, founded in 1875, with around 300 employees, is one of the world-wide leading manufacturers of Instrumentation Valves and Manifolds. The company shapes this branch with technological diversity and many innovations.

Tailored to Your Business

We offer our customers new tailored product and system solutions and are there to offer our support before, during and after the implementation of the project as your professional contact partner.

Our product line

R&D, Production and Distribution of Instrumentation Products

These instrumentation products are mainly used for pressure and differential pressure measurement in all fields of plant construction:

Oil & Gas Industry

Upstream: Onshore and Offshore Production
Midstream: Transport, Storage and Natural Gas Compression
Downstream: Refineries and Petrochemical Industry

Chemical Industry

Power Generation

Conventional Power Plants, Nuclear Power Plants, Flue Gas Desulfurization Plants

Other Plants

Waste Incineration Plants, Seawater Desalination Plants, Steel Mills, Cement Plants, etc.

R&D, Production and Distribution of Valves for Large Bore Diesel Engines

AS-Schneider supplies all manufacturers of large bore diesel engines (marine engines, power generation) with indicator valves, safety valves etc.

In this field, AS-Schneider is a world leading manufacturer.

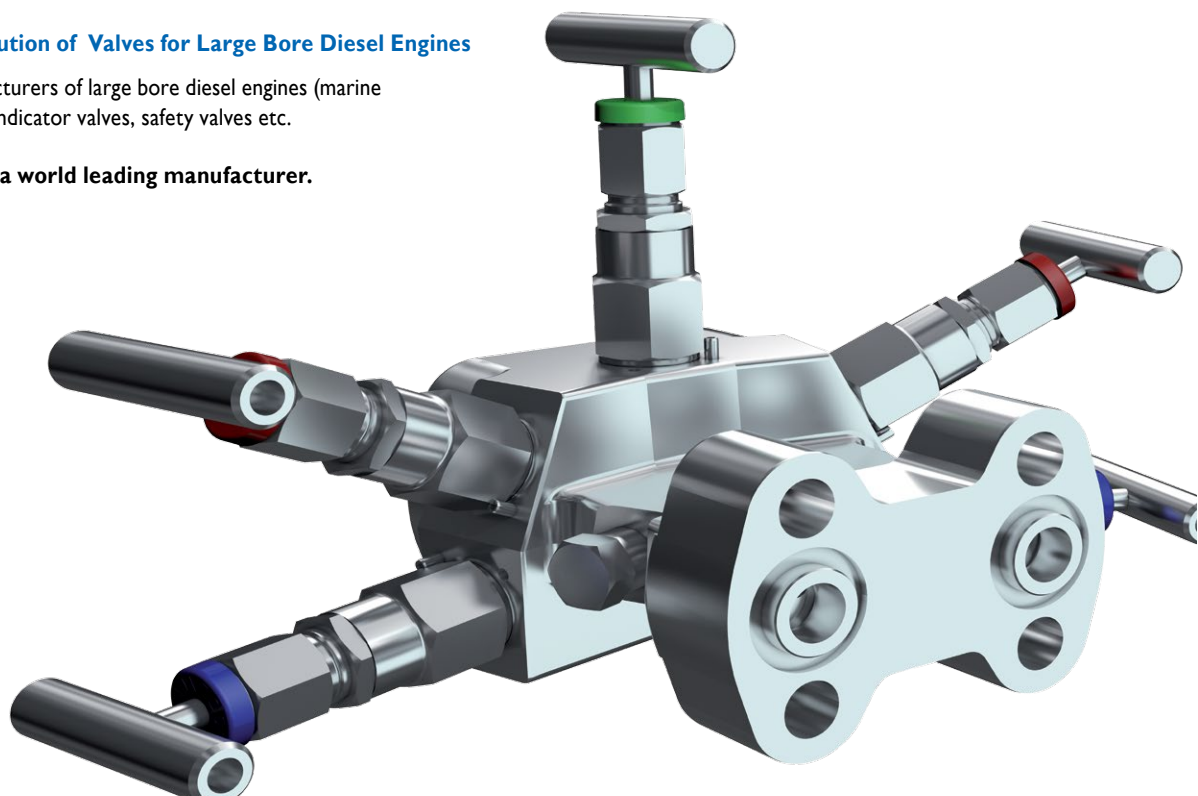

E Series Needle Valves

Needle Valves for use on general applications for liquid and gas service

Suitable for shutting-off the impulse line and for mounting to pressure instruments. These valves are provided as standard with external stem threads and 1/2 NPT threaded connections, other connections are available on request.

Standard type
PN 420 (6.092 psi), metal seated, PTFE packing for temperatures up to 200°C, material 1.4404/316L.

Options
PN 700 (10.000 psi), soft seat, soft tip, graphite packing for temperatures up to 550°C, panel mounting, anti-tamper head unit, exotic materials like Monel®, Hastelloy®, Duplex etc.

Monel® is a registered trade mark of Inco Alloys International, Inc.

Hastelloy® is a registered trade mark of Haynes International, Inc.



E Series Manifolds

2-, 3- and 5 Valve Manifolds for use on general applications for liquid and gas service

Suitable for shutting-off the impulse lines and for mounting to pressure and differential pressure instruments.

These manifolds are for direct mounting according to DIN EN 61518 or for remote mounting. The manifolds are provided as standard with external stem threads and 1/2 NPT threaded connections, other connections are available on request.

Standard type

PN 420 (6.092 psi), metal seated, PTFE packing for temperatures up to 200° C, but the manifolds for direct mounting are limited to 120° C at the transmitter/manifold interface, material 1.4404/316L.

Options

PN 700 (10.000 psi), soft seat, soft tip, graphite packing for temperatures up to 550° C, anti-tamper head unit, exotic materials like Monel®, Hastelloy®, Duplex etc.

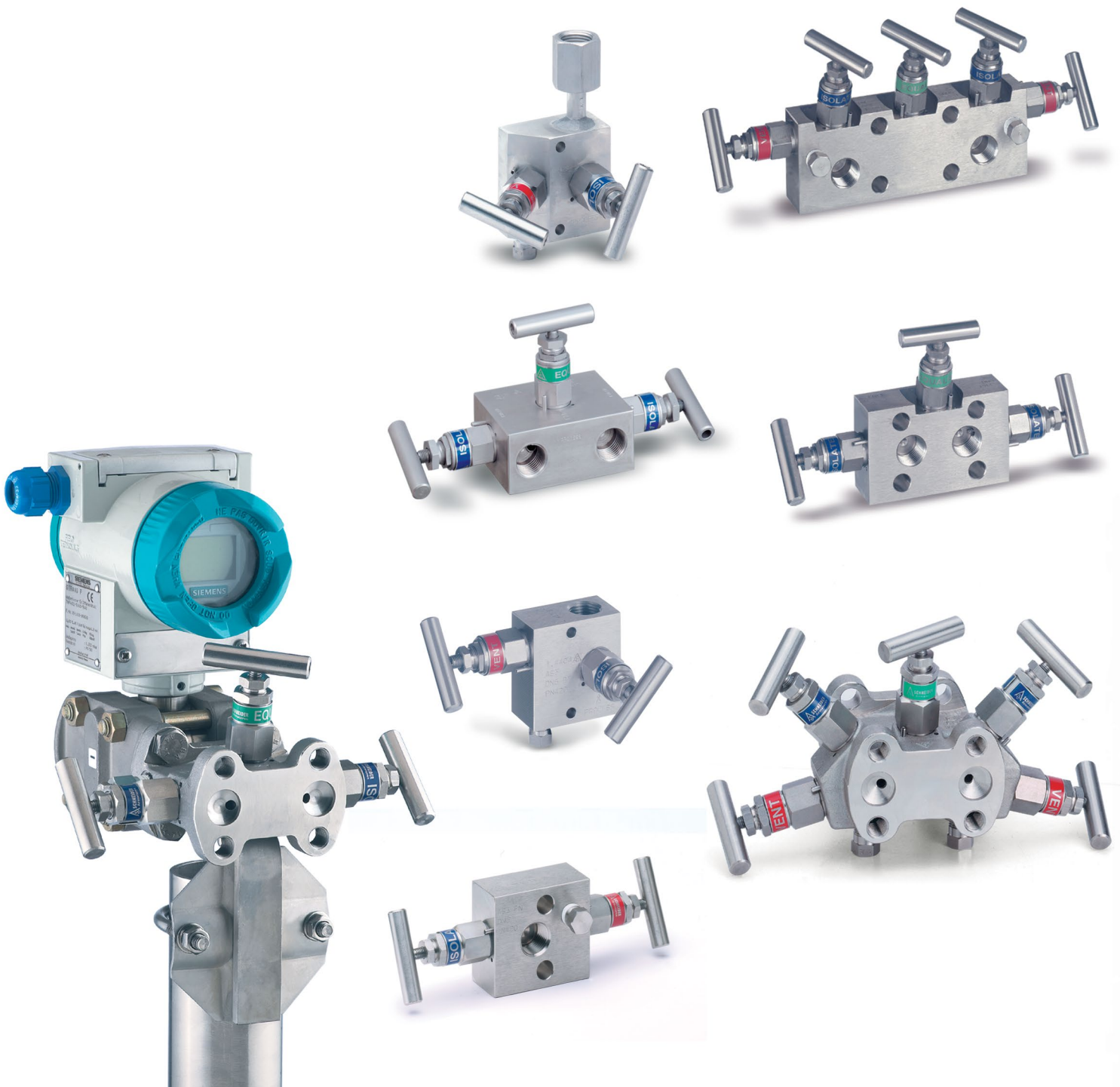

AS-Schneider Integral Manifolds

have been developed for the Rosemount® Transmitter Models 2051/3051/3095/2088.

In general, manifold and transmitter are assembled, calibrated and leak tested by Rosemount®. The compact and lightweight assembly reduces design costs, on-site assembly and testing costs. Potential leaks are minimized.

Rosemount® is a registered trade mark of Rosemount Inc.

Standard type

PN 420 (6.092 psi), metal seated, PTFE packing for temperatures up to 200° C, material 1.4404/316L.

Options

PN 700 (10.000 psi), soft seat, soft tip, graphite packing, anti-tamper head unit, exotic materials like Monel®, Hastelloy®, Duplex etc.



Valves and Manifolds acc. to ASME B 31.1

Valves and Manifolds according to requirements of ASME B 31.1

Suitable for shutting-off the impulse lines and for mounting to pressure and differential pressure instruments.

These manifolds are for direct mounting according to DIN EN 61518 or for remote mounting.

The manifolds are provided as standard with external stem threads and 1/2 NPT threaded connections, other connections are available on request.

- Pressure and temperature rating according to ASME B 16.34 Class 2500
- Material requirements in accordance with ASTM specifications
- Marking in accordance with MSS SP-25
- Pressure testing in accordance with MSS SP-61
- Valve head unit with lock plate and graphite packing



Valves and Manifolds for Natural Gas

Manifolds for use on transporting, storing and processing of natural gas

Suitable for shutting-off the impulse lines and for mounting to pressure and differential pressure instruments.

These manifolds are provided as standard with external stem threads and 1/2NPT or G1/2 threaded connections, other connections are available on request.

Standard type

PN 420 (6.092 psi), metal seated or with soft tip, PTFE packing or FPM O-ring for temperatures up to 200° C, material 1.4404/316L.

Options

Anti-tamper head unit, exotic materials like Monel®, Hastelloy®, Duplex etc.

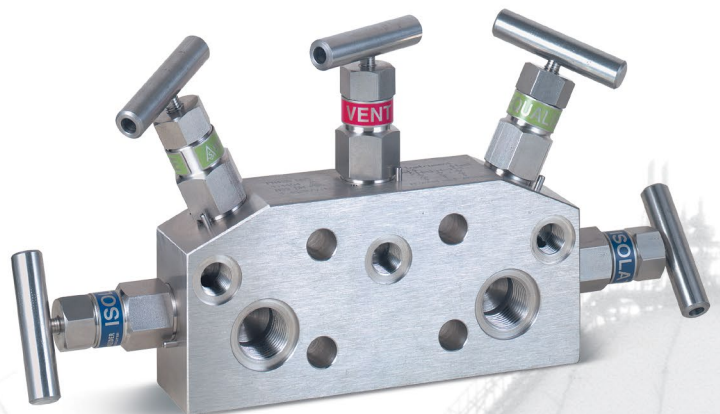
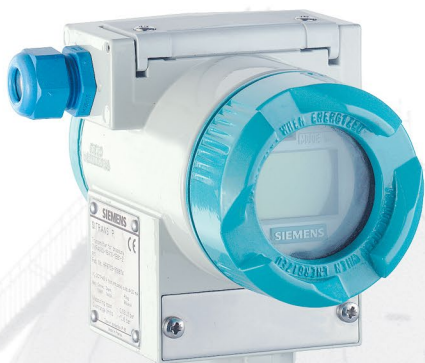
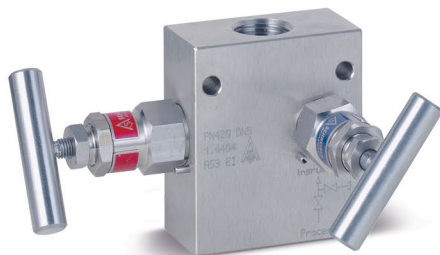

VariAS-Blocks and Monoflanges

AS-Schneider Monoflange Series and VariAS-Blocks

have been designed to replace the traditional assemblies with a compact manifold.

The monoflange series are available as Process Monoflange and Instrument Monoflange.

Monoflange and VariAS-Block are available with connections according to ASME, API, EN or DIN and as Block, Block & Bleed or Double Block & Bleed Design. Fire Safe and NACE requirements optional.

Features

- Weight saving
- Compact assembly
- Reduced stress from loading and vibration
- Reduction of leak points
- Reduction of installation and maintenance costs

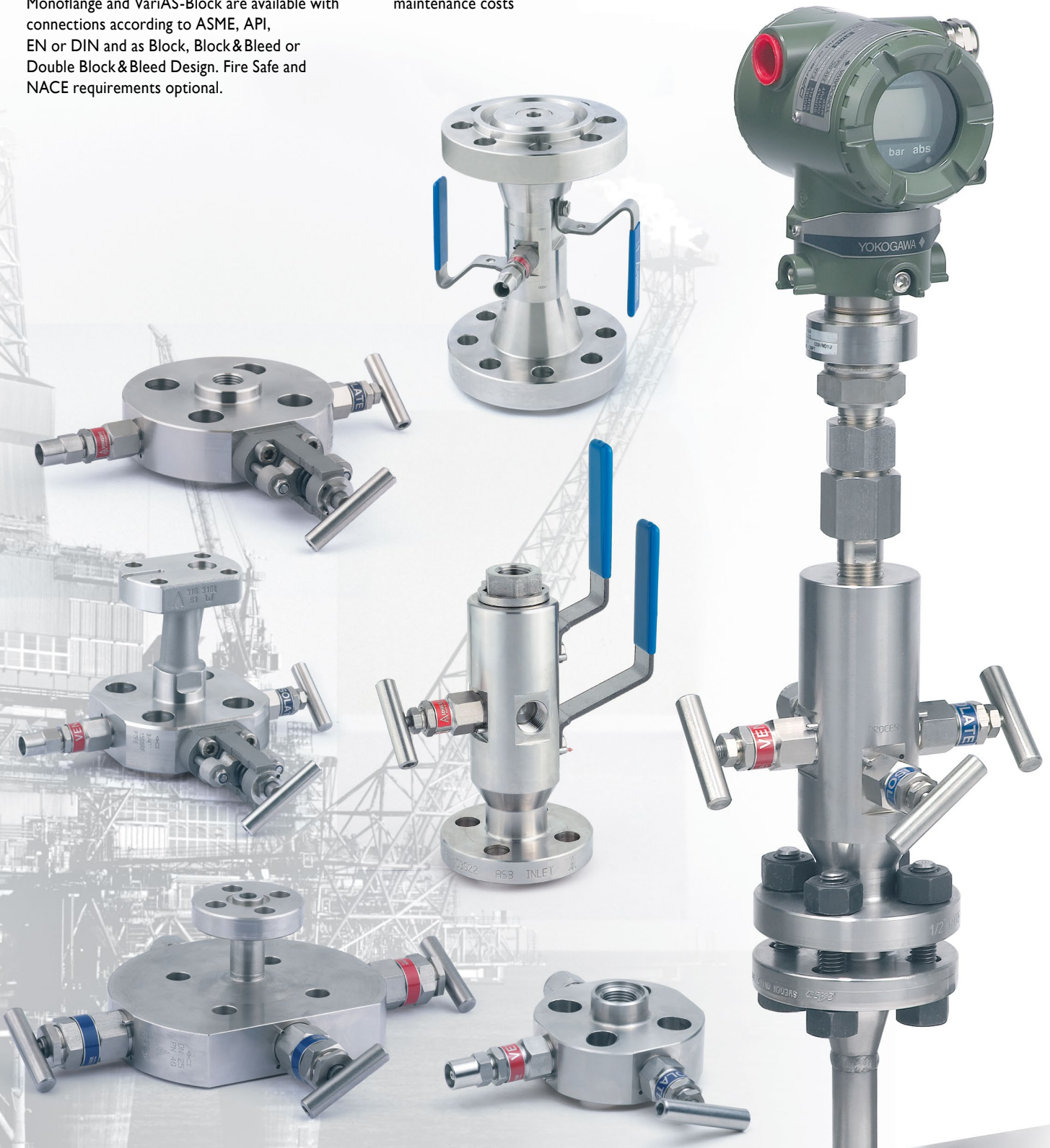

AS-Schneider CloseCouplings

These products are designed to help you to overcome the problems associated with traditional instrument / manifold installations that are connected with impulse lines.

The trend towards direct mounted designs results from the technological developments of the pressure transmitters with less maintenance and calibration effort.

The direct mounting design 'AS-Schneider CloseCouplings' shows following important advantages in comparison with the conventional installation with impulse lines:

- Weight saving
- Compact assembly
- No impulse lines
- Reduction of measurement errors
- Reduction of potential leak points
- Reduction of installation and maintenance costs
- Assembly/welding in an industrially-manufactured series quality

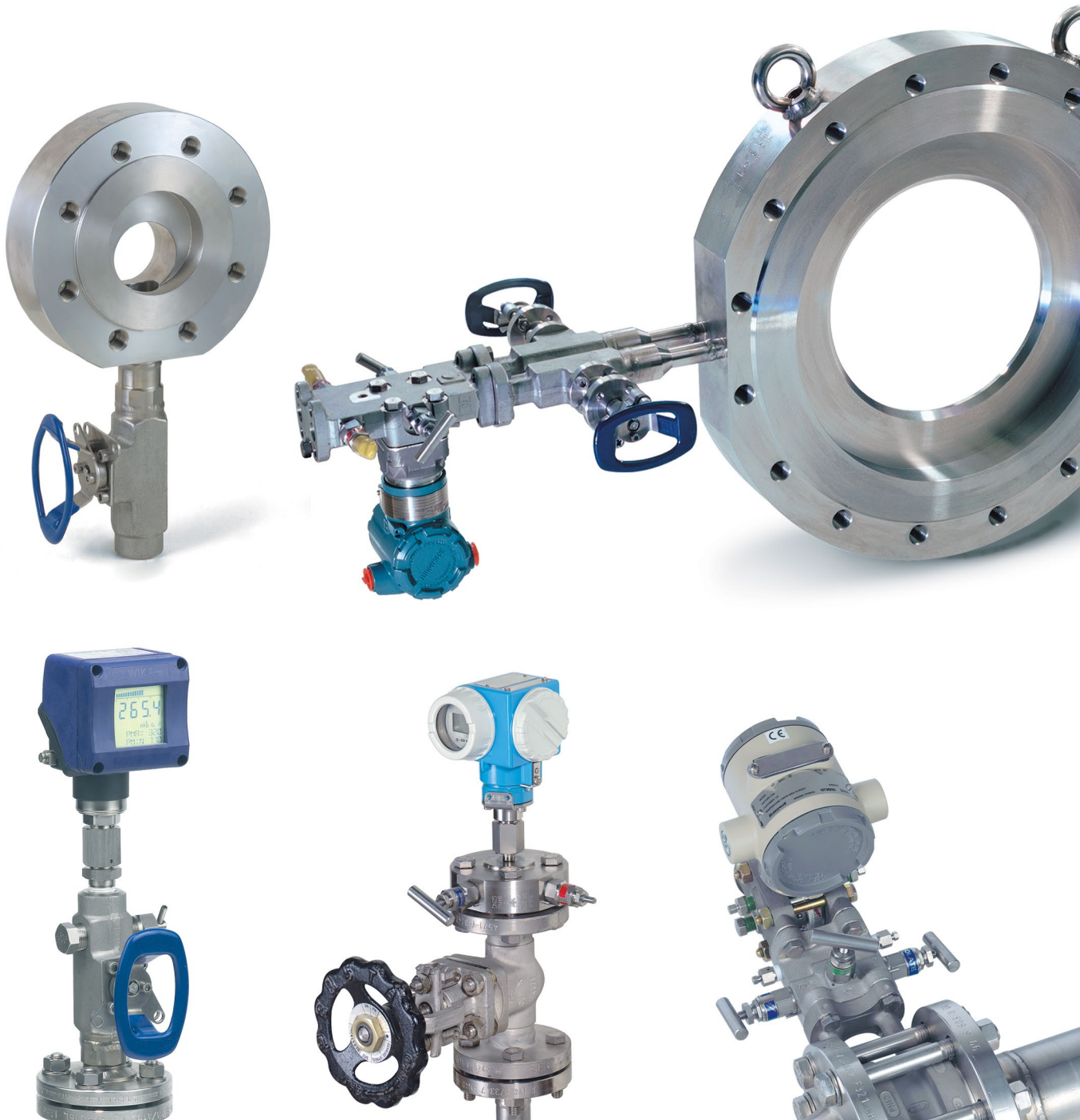

EDM Series Manifolds for Enclosure Assemblies

2, 3 and 5 Valve Manifolds for direct mounting in enclosures

Furthermore they can be used in connection with a mounting bracket for wall, rack or 2" pipe mounting.

Suitable for shutting-off the impulse lines and for mounting to pressure and differential pressure instruments. The EDM series manifolds are provided as standard with external stem threads and 1/2 NPT threaded connections, other connections are available on request.

Standard type

PN 420 (6.092 psi), metal seated, PTFE packing for temperatures up to 200° C, but the manifolds for direct mounting are limited to 120° C at the transmitter/manifold interface, material 1.4404/316L.

Options

Soft seat, soft tip, graphit packing, anti-tamper head unit, exotic materials like Monel®, Hastelloy®, Duplex etc.

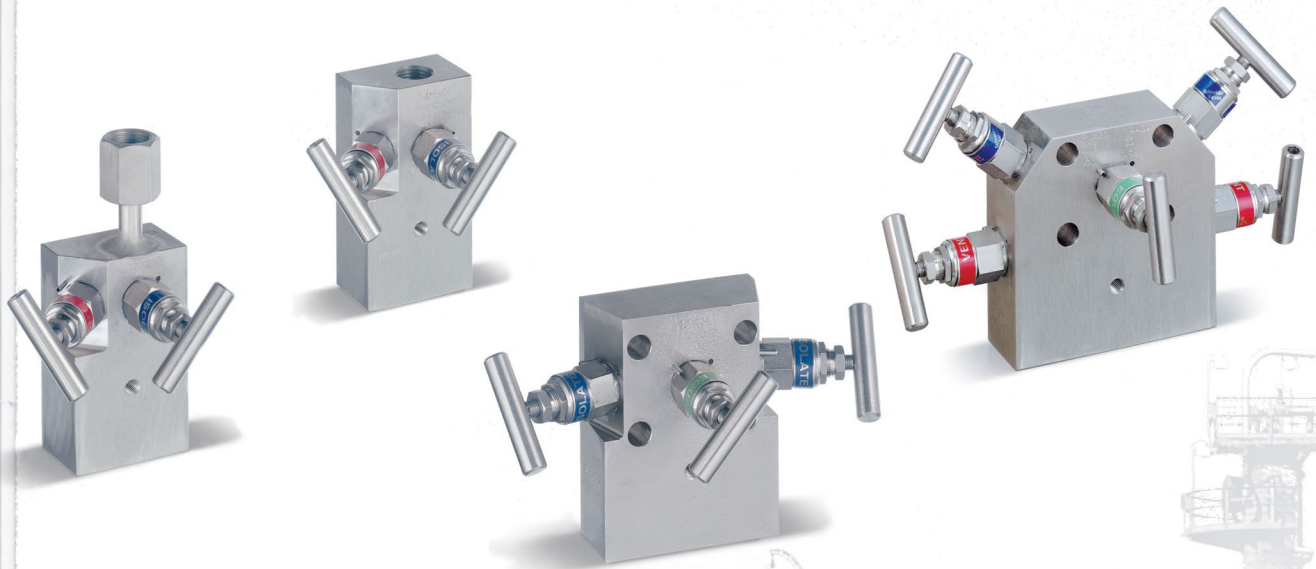

Shut-Off Valves for use on general applications for liquid, gas and steam service

Suitable for shutting-off the impulse line and as primary isolation valve.

Available with welded connections, threaded connections and compression fittings.

Forged valve bodies made of high-temperature, heat-resistant or corrosion-resistant steels.

Nominal pressures from PN 100 up to PN 700, suitable for temperatures up to 550°C.



Manifolds, Manifold Combinations and Multi-Way Cocks

2, 3 and 5 Valve Manifolds, Manifold Combinations and Multi-Way Cocks for use on general applications for liquid, gas and steam service

Suitable for shutting-off the impulse lines and for mounting to pressure and differential pressure instruments.

These manifolds, manifold combinations and multi-way cocks are for direct mounting according to DIN EN 61518 or for remote mounting.

Process connections

Compression fitting or welded connection.

Manifolds

PN 420 (6.092 psi), metal seated, PTFE packing for temperatures up to 200°C, but the manifolds for direct mounting are limited to 120°C at the transmitter/manifold interface.

Graphite packings and sealing rings are available for high temperature service.

The purge valves on the manifold combinations are suitable for temperatures up to 550°C.

Multi-way cocks

PN 100, plug seal made of PTFE carbon.

Materials

P250 GH (1.0460) and 1.4571, purge valves on the manifold combinations are made of high-temperature steels.

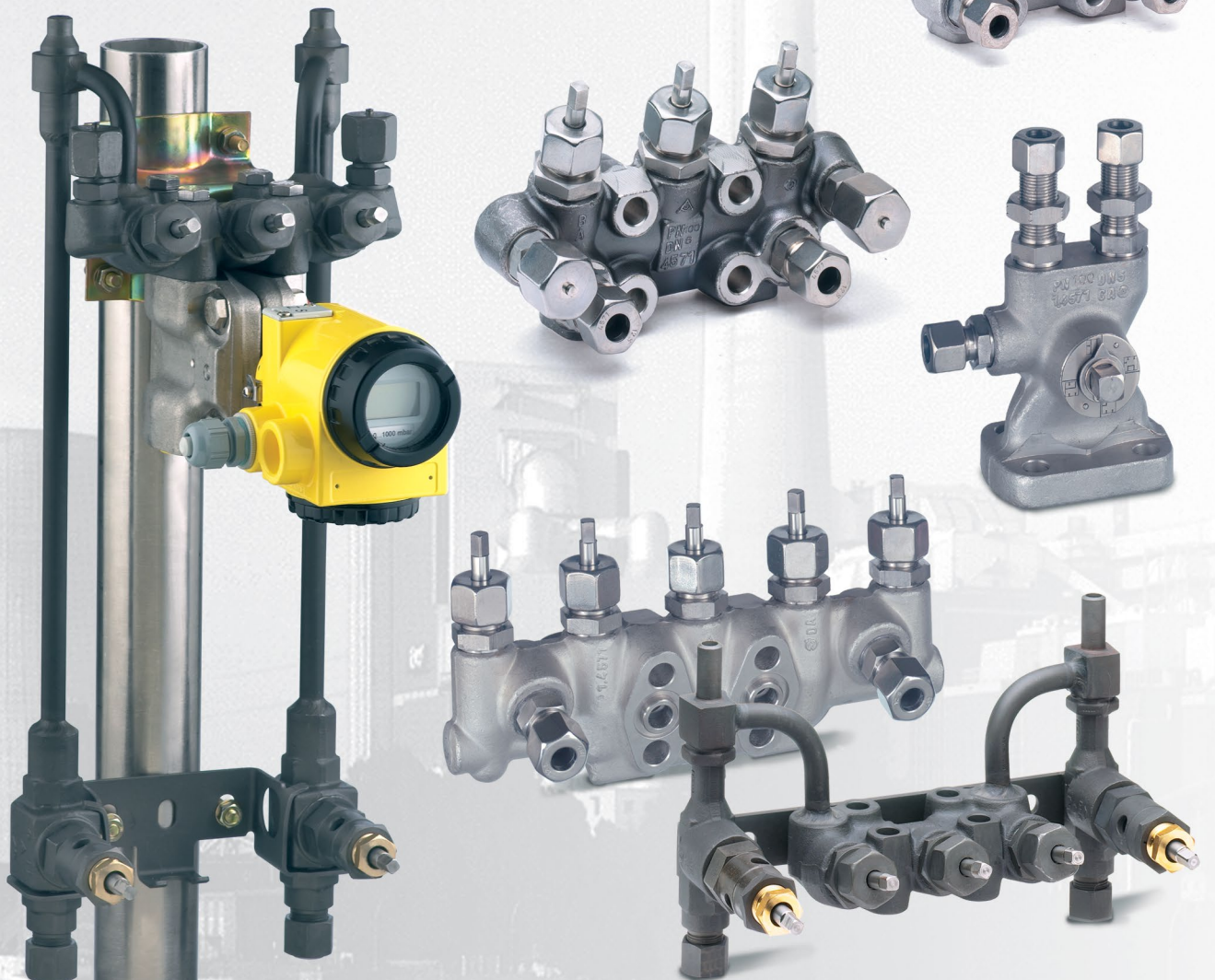

Special Types and Options

Armaturenfabrik Franz Schneider offers a big variety of valves and manifolds with different options

- According to NACE MR0175/ISO15156
- According to TA-Luft (Fugitive Emissions)
- Cleaned and degreased for oxygen service
- For chlorine service
- Bellows sealed
- Lockable
- With a heated shell
- Exotic materials
- With soft seat or soft tip
- Flanged valves
- Ball valves with forged oval flange
- Cryogenic valves
- Valves and manifolds specially designed for customers

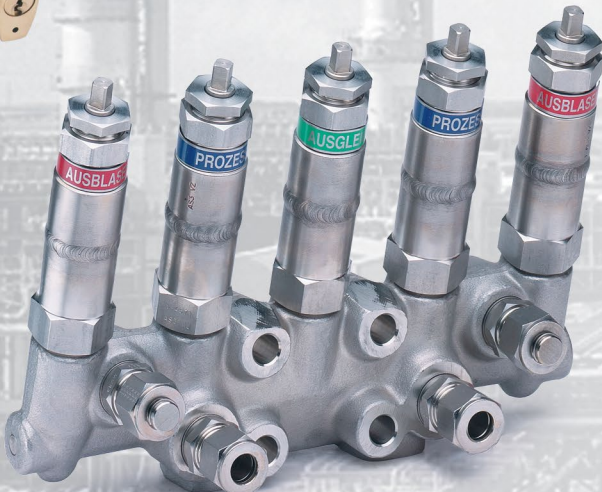
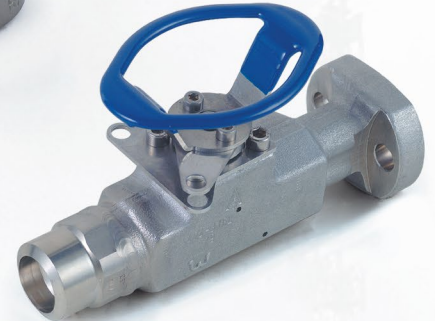

Air Headers & Mounting Accessories

AS-Schneider Air Headers are designed and manufactured according to customer specifications

Pipe dimension
1" and 2".

Process connection
DIN and ASME flanges or threaded connections

Outlet ports

- Number of ports 2–20
- On one or on both sides
- Assembled with ball valves as standard

Materials

1.4404 (316L), 1.4571 (316Ti)

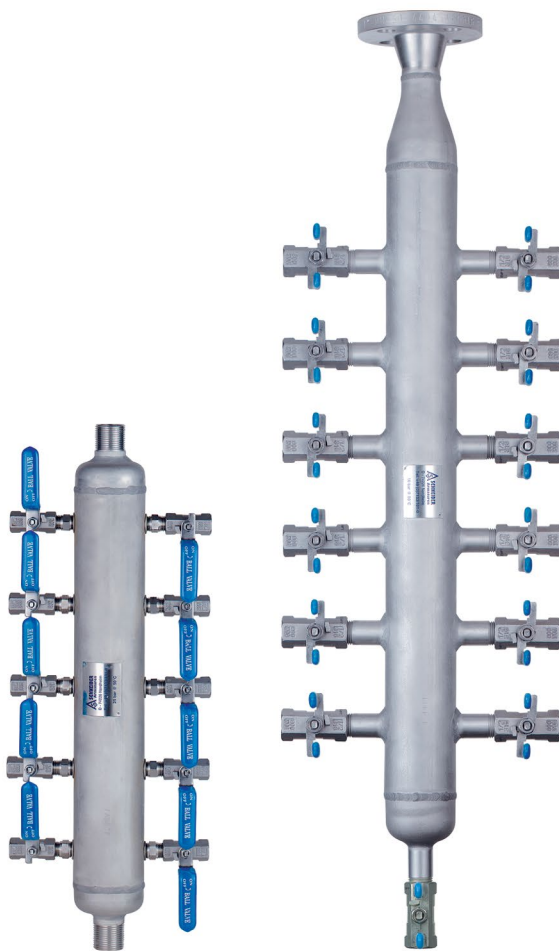

Mounting Accessories

- Flanges
- Mounting brackets
- Condensation pots
- Swivel gauge adaptors
- Nipples
- Vent valves
- Accessory kits for manifolds
- Tees
- Adaptors





schneider

Tailored to Your Business



Armaturenfabrik Franz Schneider GmbH+ Co. KG

Bahnhofplatz 12 | 74226 Nordheim
Deutschland / Germany

Tel: +49 71 33 101-0

Fax: +49 71 33 101-148



www.as-schneider.com



AS-Schneider Asia-Pacific Pte. Ltd.

970 Toa Payoh North, #02-12/14/15
Singapore 318992

Tel: +65 62 51 39 00

Fax: +65 62 51 39 90



www.as-schneider.sg



Armaturenfabrik Franz Schneider SRL

Sales Office:
Str. Basarabilor, Nr. 7 | 100036 Ploiesti
Romania

Tel: +40 244 384 963

Fax: +40 244 384 963

Production Plant:
Str. Mihai Viteazu, Nr. 327i | 507085 Harman
Jud. Braşov | Romania

Tel: +40 368 41 40 25

Fax: +40 368 41 40 26



www.as-schneider.ro



AS-Schneider Middle East FZE

P.O. Box 18749 | Dubai
United Arab Emirates

Tel: +971 4 880 85 75

Fax: +971 4 880 85 76



www.as-schneider.ae



AS-Schneider America, Inc.

17421 Village Green Dr | Houston, TX 77040
United States of America

Tel: +1 281 2 58 42 63

Fax: +1 281 5 06 79 35



www.as-schneider.com