

$13/16$ [20.64]

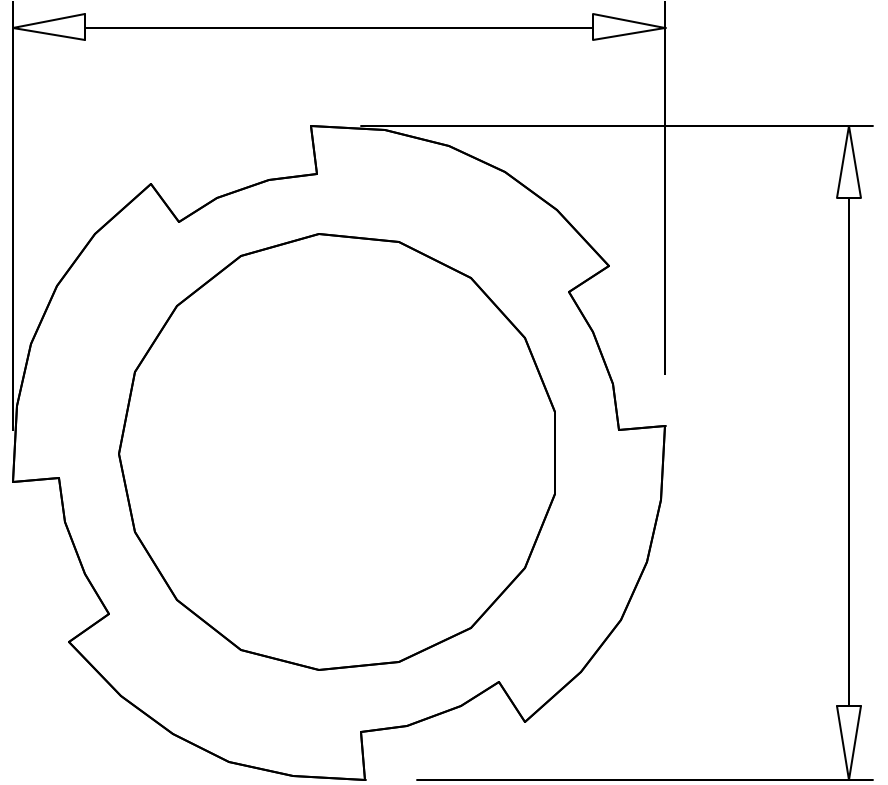

$13/16$ [20.62]