

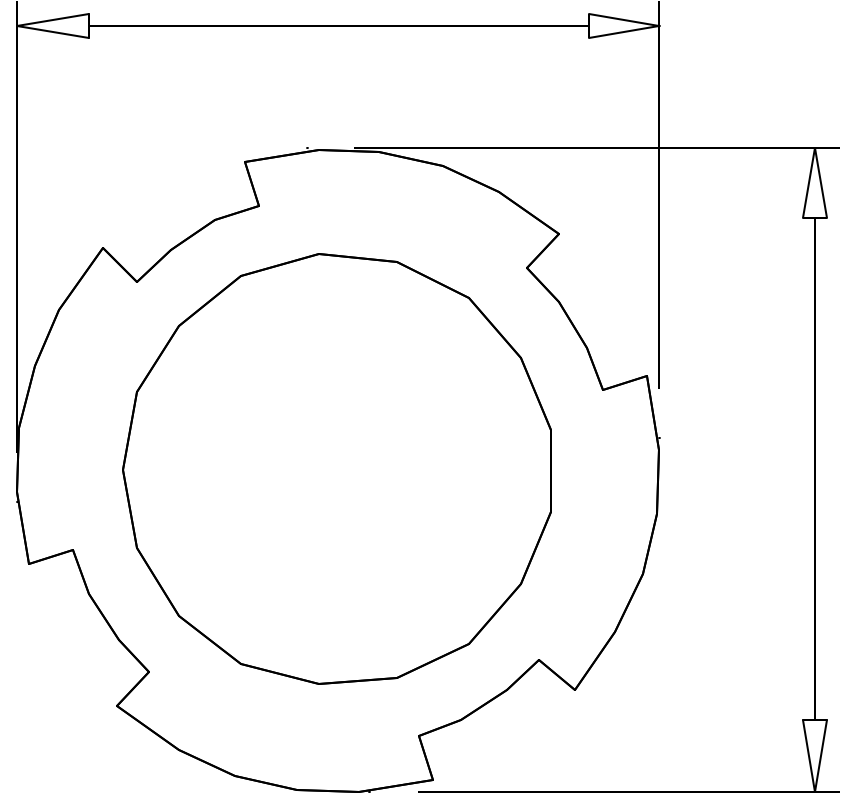

$13/16$  [20.59]



$13/16$  [20.61]