

94.96 [3 47/64]

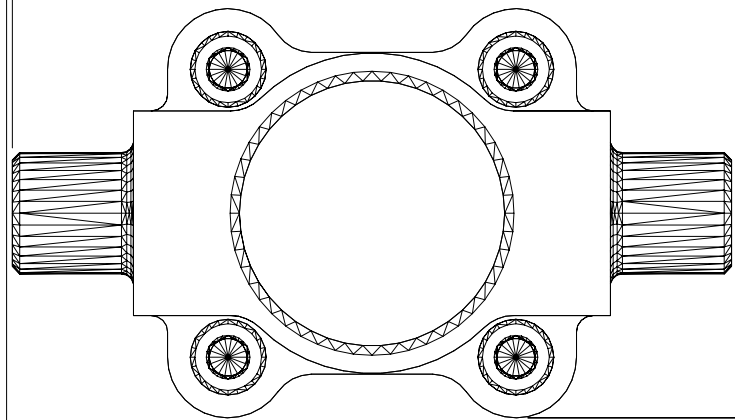

54.00 [2 1/8]

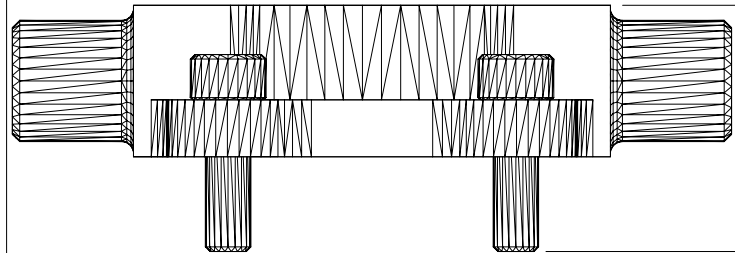

32.50 [1 9/32]

MPAR-NA174414
Trunnion flange, Sp.
steel, 63

