

334.79 [13 3/16]

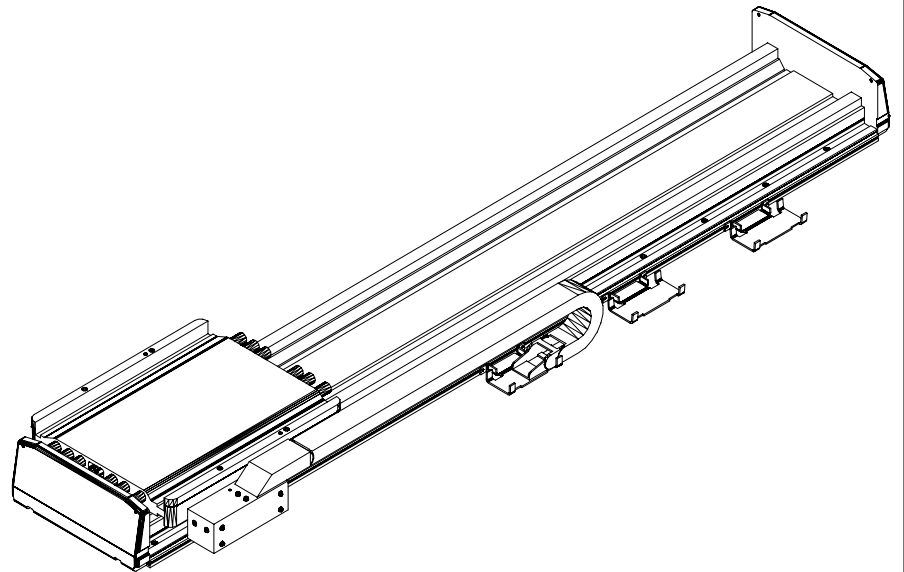

105.40 [4 5/32]



MPAS-B9104L-ALM02C
MP Linear Stage,
Frame 250, 460v,
1040mm Stroke Length,
Incremental Encoder,
LC 75X200 Motor Coil,
without Cover