

334.79 [13 3/16]

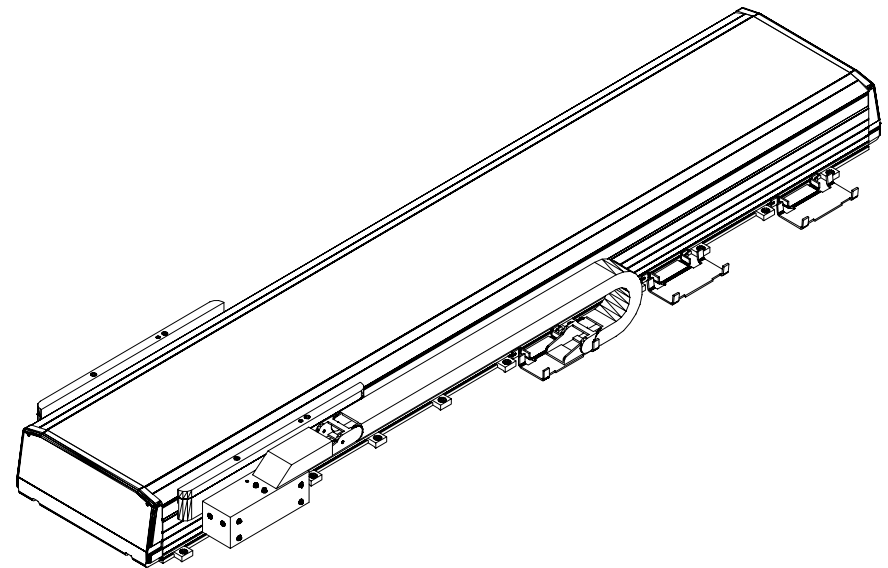

105.40 [4 5/32]



MPAS-B9092L-ALMS2C
MP Linear Stage,
Frame 250, 460v,
920mm Stroke Length,
Incremental Encoder,
LC 75X200 Motor Coil,
with Cover