

281.01 [11 1/16]

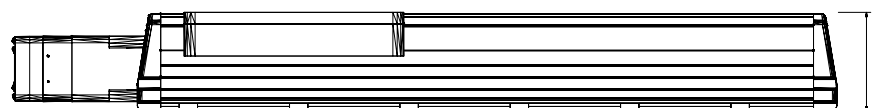

105.40 [4 5/32]

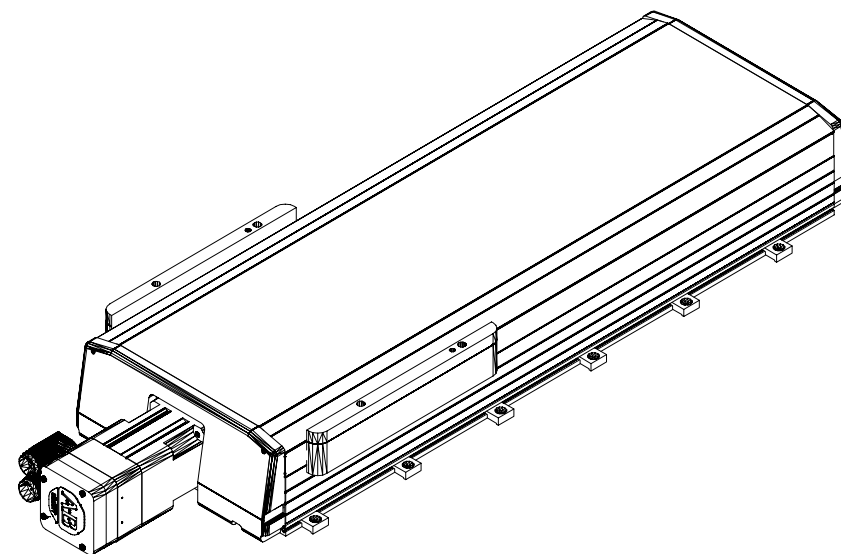

MPAS-B90421-V05S4A
MP Linear Stage, Frame
250, 460v, 420mm
Stroke Length,
Multi-turn, 05mm Screw
Lead, with Cover