

281.01 [11 1/16]

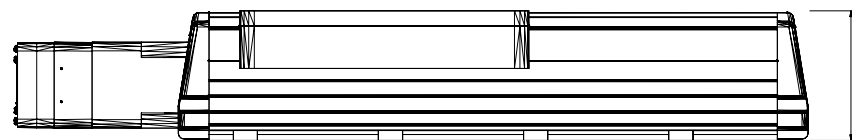

105.40 [4 5/32]

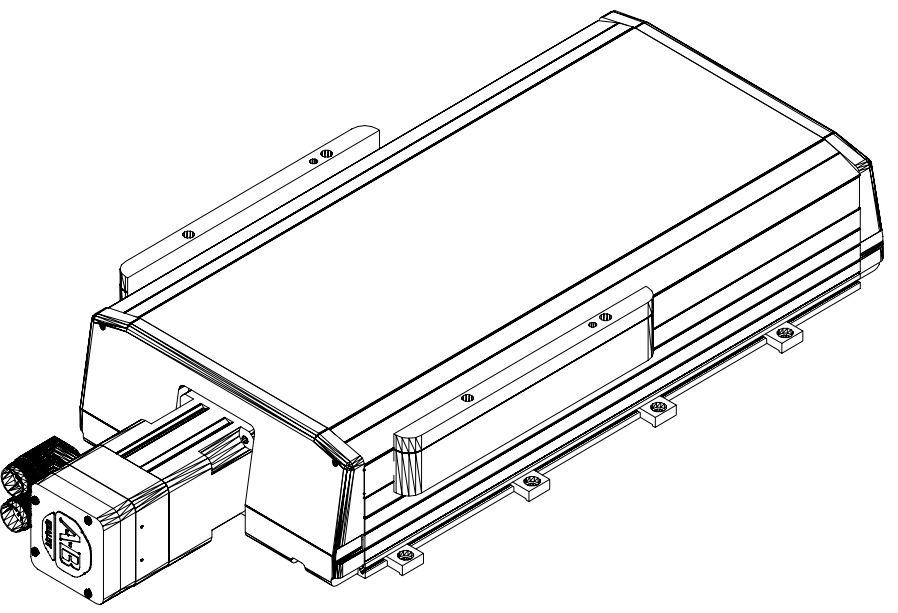

MPAS-B90181-V05S4A
MP Linear Stage, Frame
250, 460v, 180mm Stroke
Length, Multi-turn,
05mm Screw Lead, with
Cover and Brake