

280.51 [11 3/64]

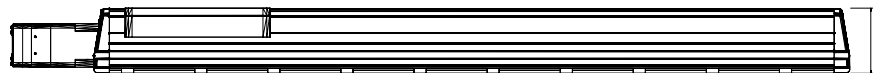

105.40 [4 5/32]

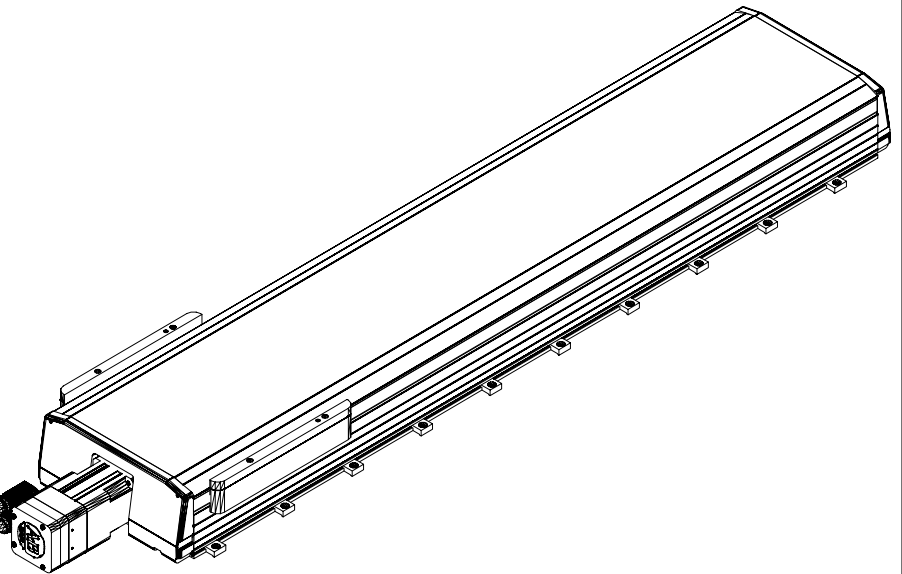

MPAS-A90901-V05S4A
MP Linear Stage, Frame
250, 230v, 900mm Stroke
Length, Multi-turn, 05mm
Screw Lead, with Cover
and Brake