

281.01 [1 7/64]

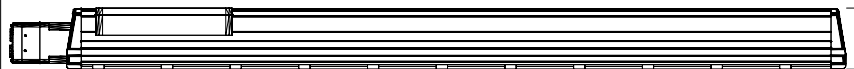

105.40 [4 5/32]

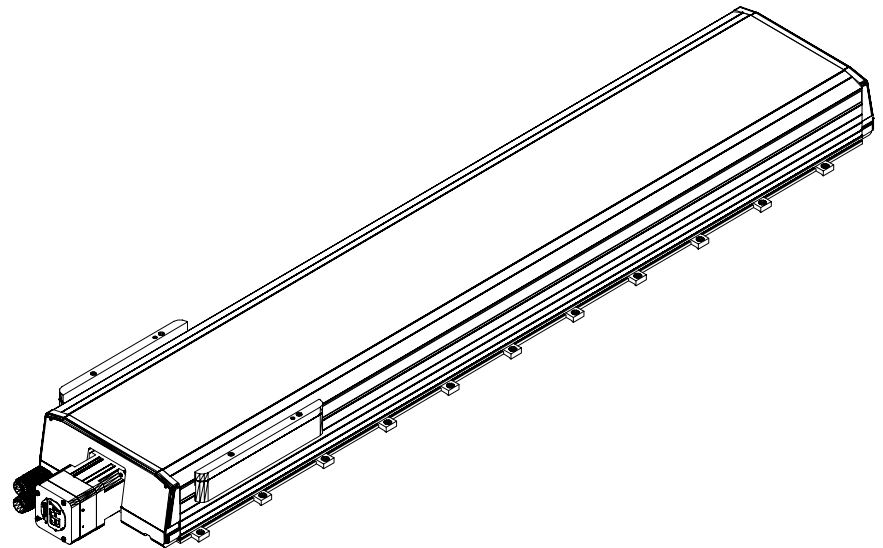

MPAS-B91021-V05S2A  
MP Linear Stage, Frame  
250, 460v, 1020mm  
Stroke Length,  
Multi-turn, 05mm Screw  
Lead, with Cover