

281.01 [11 1/16]

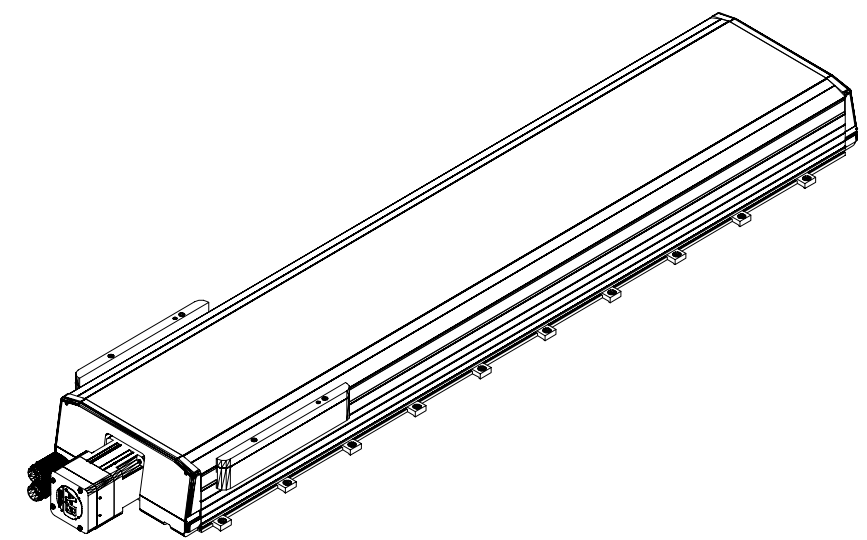

105.40 [4 5/32]



MPAS-A90901-V05S2A
MP Linear Stage, Frame
250, 230v, 900mm
Stroke Length,
Multi-turn, 05mm Screw
Lead, with Cover