

281.01 [11 1/16]

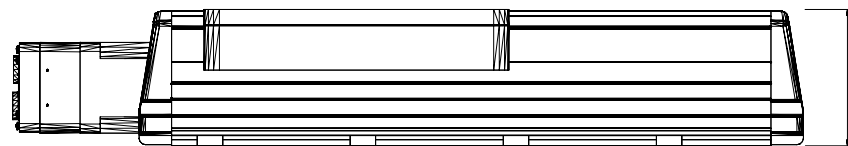

105.40 [4 5/32]

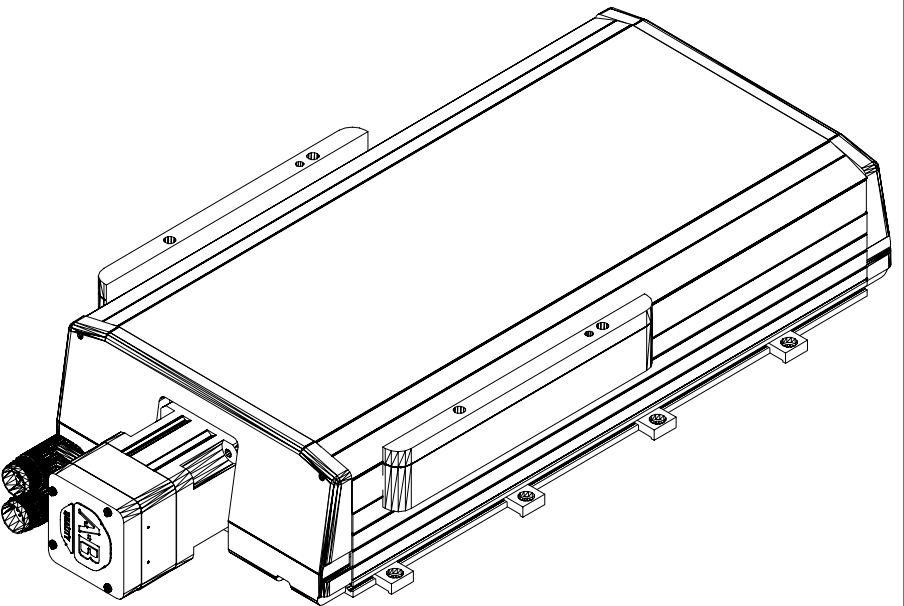

MPAS-A90181-V05S2A  
MP Linear Stage, Frame  
250, 230v, 180mm Stroke  
Length, Multi-turn,  
05mm Screw Lead, with  
Cover