

281.01 [11 1/16]

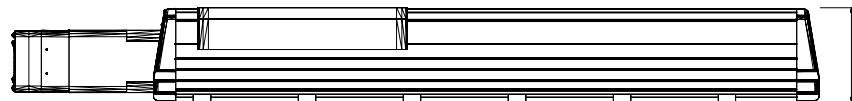

105.40 [4 5/32]

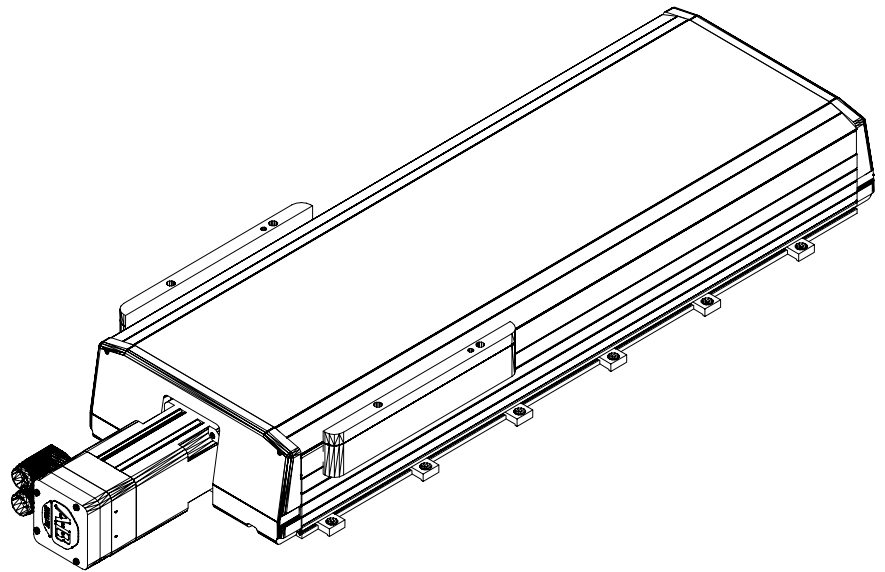

MPAS-A90422-V20S4A
MP Linear Stage, Frame
250, 230v, 420mm Stroke
Length, Multi-turn, 20mm
Screw Lead, with Cover
and Brake