

281.01 [11 1/16]

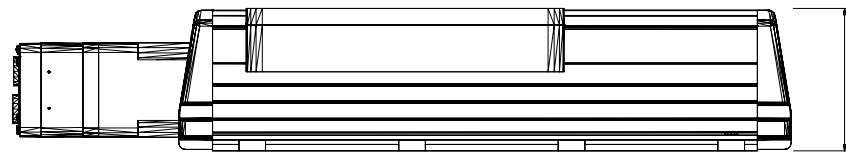

105.40 [4 5/32]

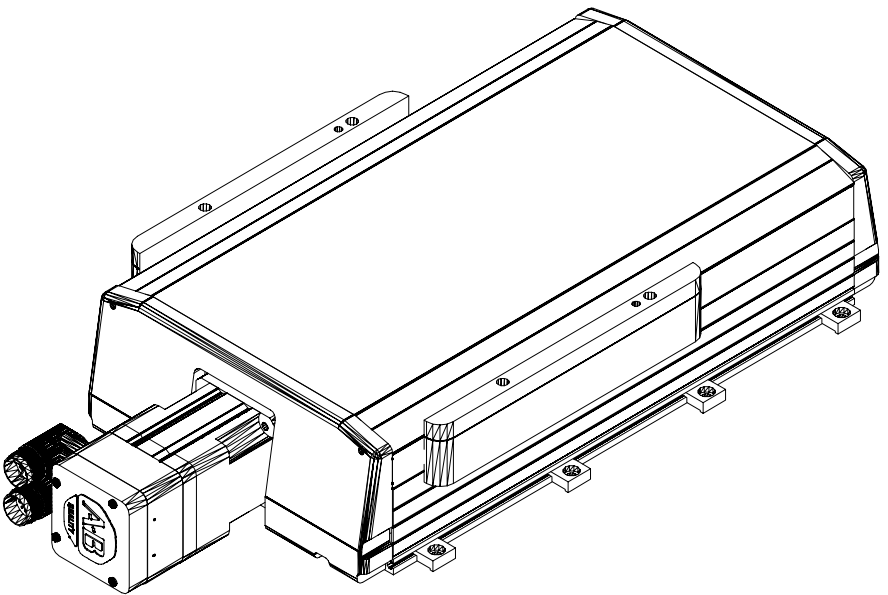

MPAS-B90122-V20S2A
MP Linear Stage, Frame
250, 460v, 120mm Stroke
Length, Multi-turn, 20mm
Screw Lead, with Cover