

281.01 [11 1/16]

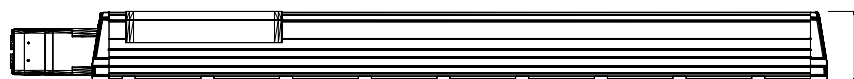

105.40 [4 5/32]

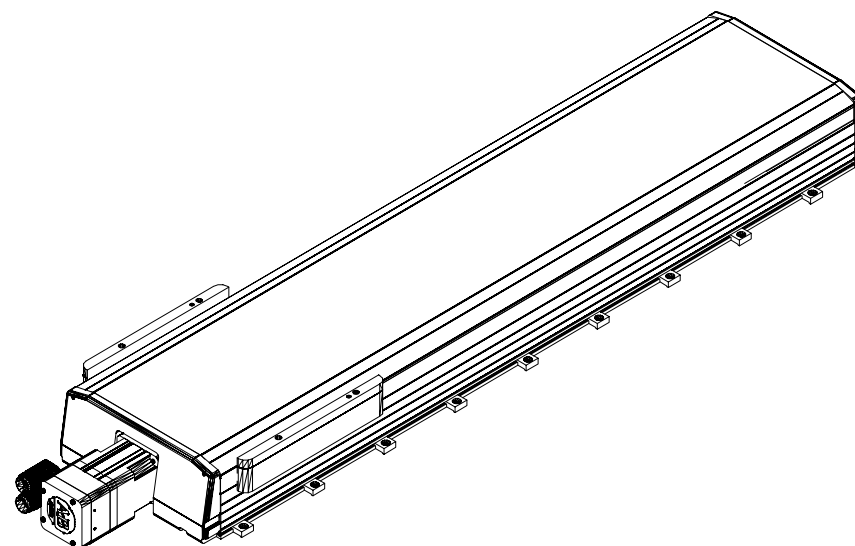

MPAS-A90782-V20S2A  
MP Linear Stage, Frame  
250, 230v, 780mm  
Stroke Length,  
Multi-turn, 20mm Screw  
Lead, with Cover