

281.01 [11 1/16]

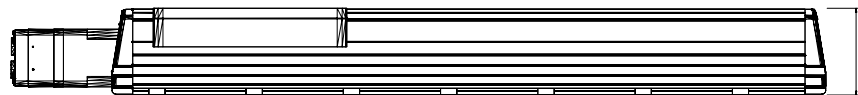

105.40 [4 5/32]

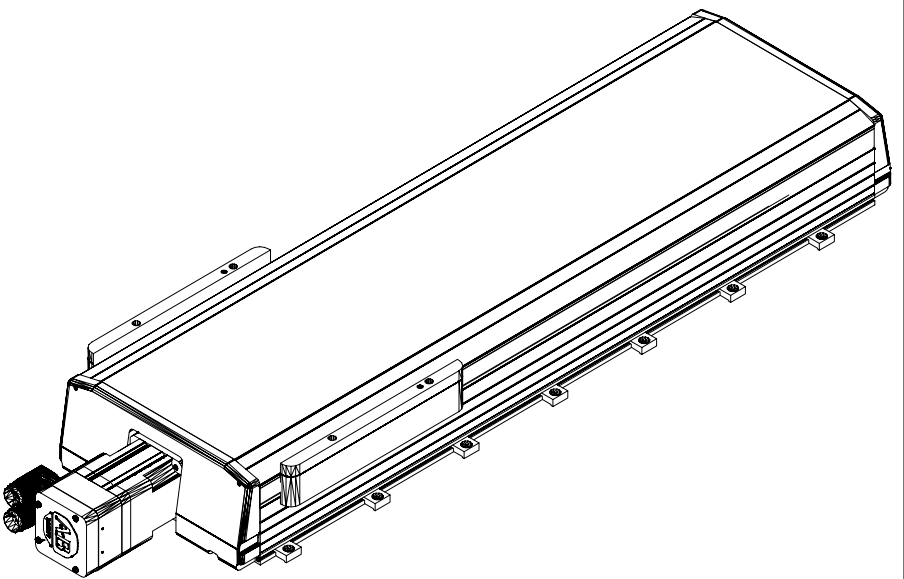

MPAS-A90542-V20S2A
MP Linear Stage, Frame
250, 230v, 540mm
Stroke Length,
Multi-turn, 20mm Screw
Lead, with Cover