

232.01 [9 9/64]

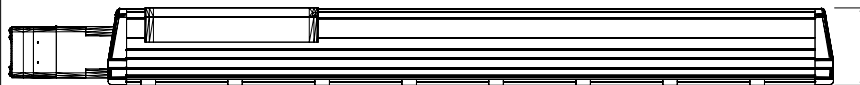

105.40 [4 5/32]

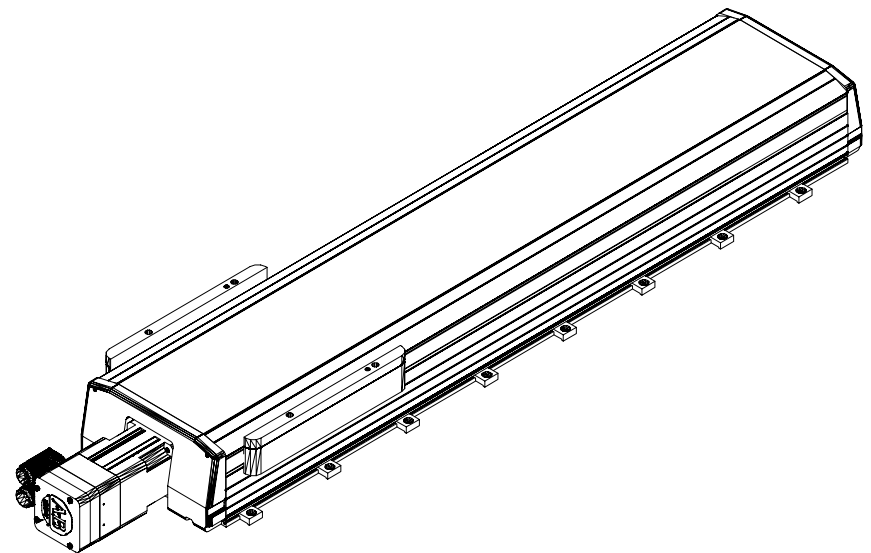

MPAS-B80661-V05S4A
MP Linear Stage, Frame
200, 460v, 660mm Stroke
Length, Multi-turn, 05mm
Screw Lead, with Cover
and Brake