

232.01 [9 9/64]

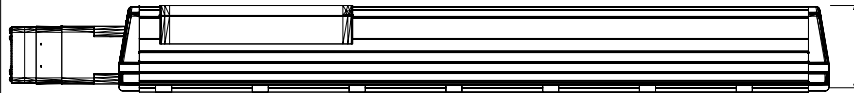

100.28 [3 61/64]

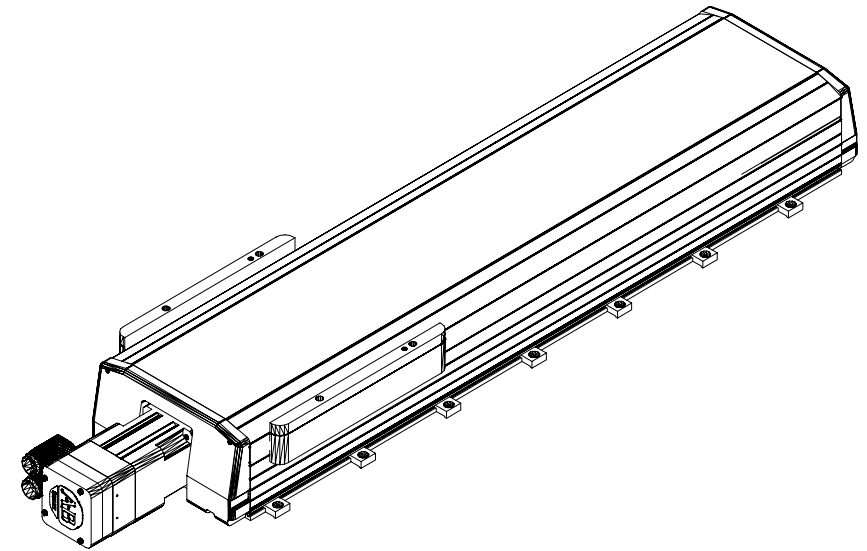

MPAS-B80541-V05S4A
MP Linear Stage, Frame
200, 460v, 540mm Stroke
Length, Multi-turn, 05mm
Screw Lead, with Cover
and Brake