

232.01 [9 9/64]

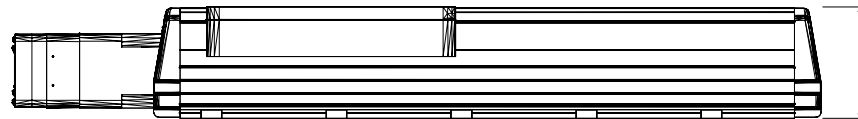

105.40 [4 5/32]

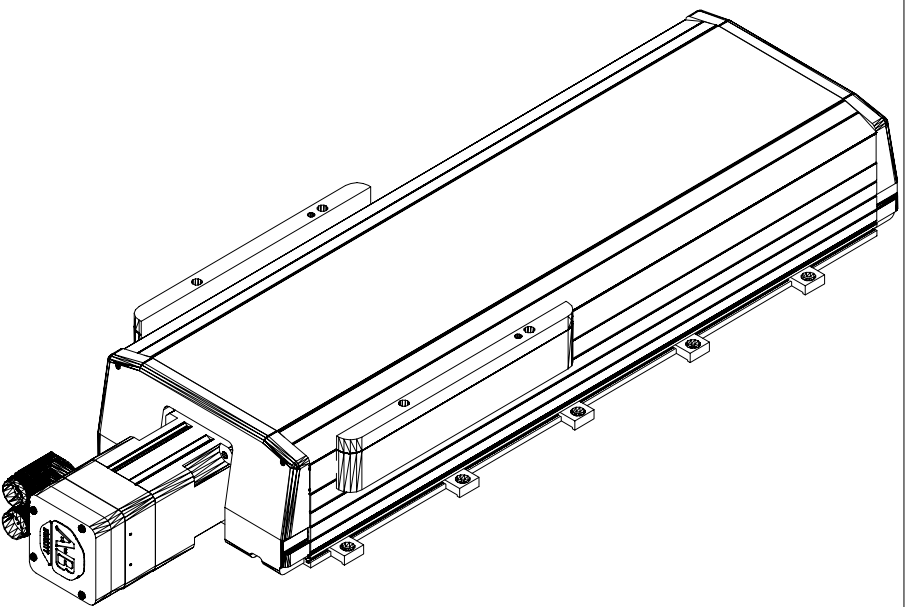

MPAS-B80301-V05S4A
MP Linear Stage, Frame
200, 460v, 300mm Stroke
Length, Multi-turn,
05mm Screw Lead, with
Cover and Brake