

232.01 [9 9/64]

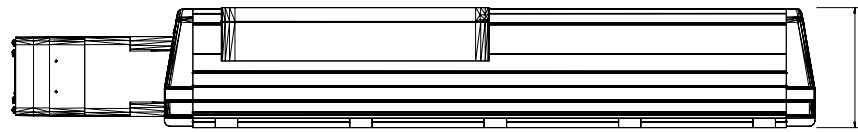

105.40 [4 5/32]

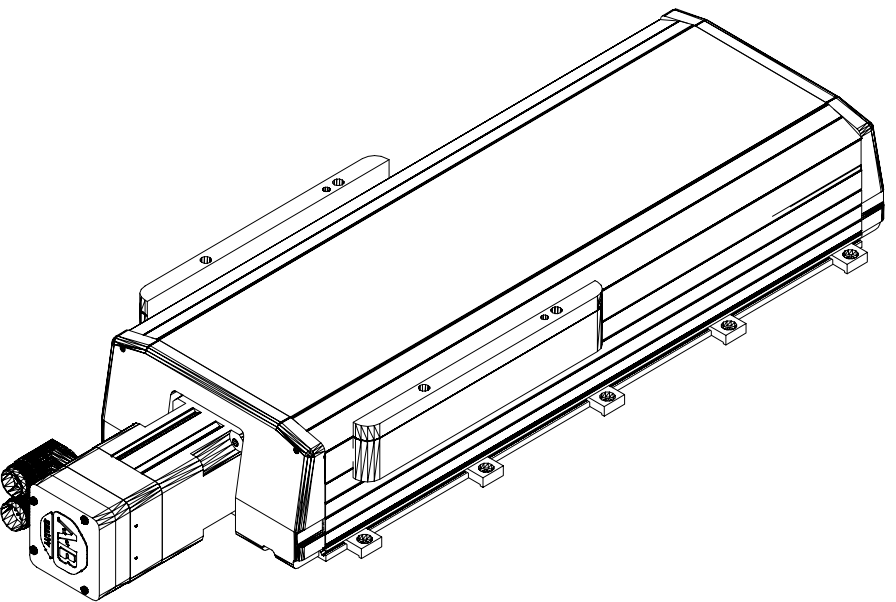

MPAS-B80241-V05S4A  
MP Linear Stage, Frame  
200, 460v, 240mm Stroke  
Length, Multi-turn, 05mm  
Screw Lead, with Cover  
and Brake