

232.01 [9 9/64]

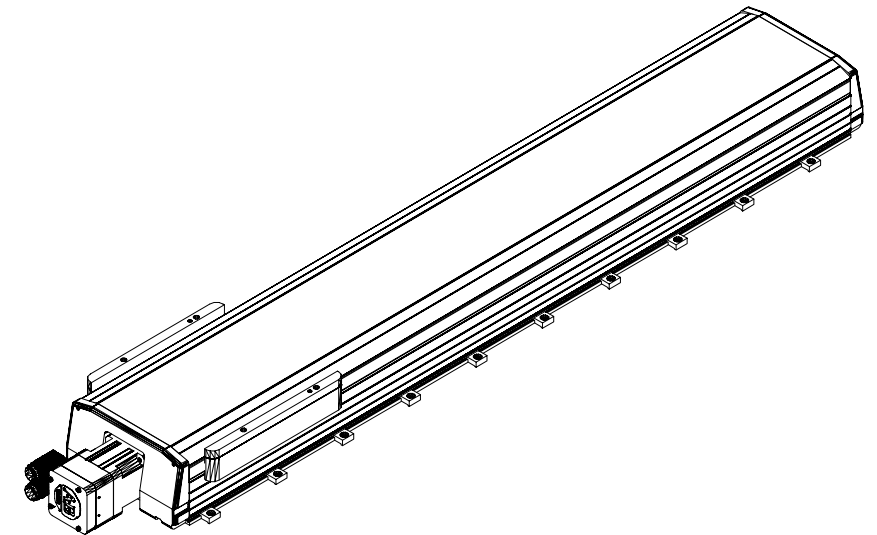

100.28 [3 61/64]



MPAS-A80901-V05S2A
MP Linear Stage, Frame
200, 230v, 900mm Stroke
Length, Multi-turn, 05mm
Screw Lead, with Cover